

IBM AS/400 Printing V

A primer on AS/400 printing in today's networked environment

Configuration, performance, problem determination, enhancements

In-depth education on AFP and ASCII printing

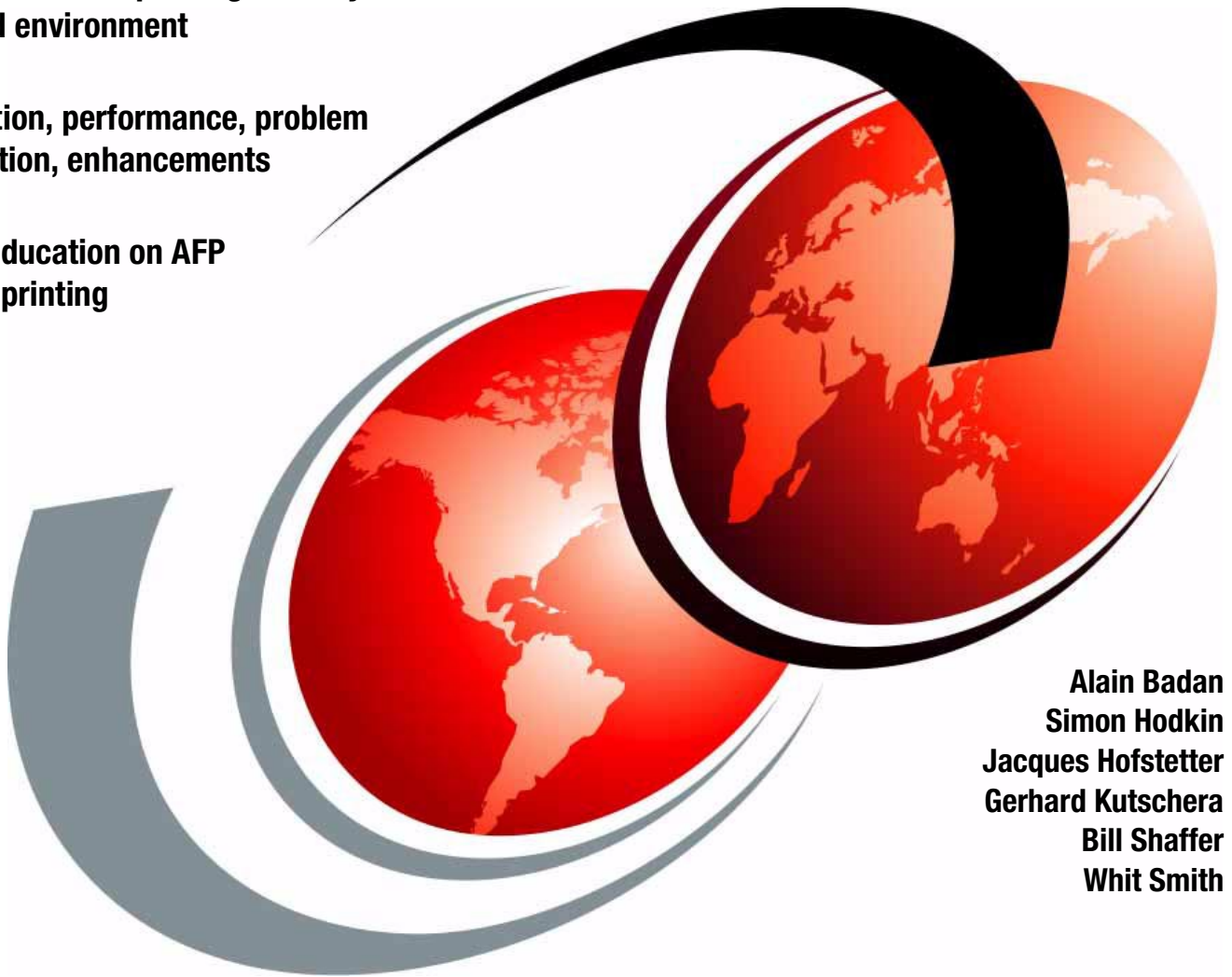

Alain Badan
Simon Hodkin
Jacques Hofstetter
Gerhard Kutschera
Bill Shaffer
Whit Smith



International Technical Support Organization

SG24-2160-01

IBM AS/400 Printing V

October 2000

Take Note!

Before using this information and the product it supports, be sure to read the general information in Appendix L, "Special notices" on page 407.

Second Edition (October 2000)

The document was created or updated on June 12, 2001.

Comments may be addressed to:
IBM Corporation, International Technical Support Organization
Dept. JLU Building 107-2
3605 Highway 52N
Rochester, Minnesota 55901-7829

When you send information to IBM, you grant IBM a non-exclusive right to use or distribute the information in any way it believes appropriate without incurring any obligation to you.

© Copyright International Business Machines Corporation 1998, 2000. All rights reserved.

Note to U.S Government Users - Documentation related to restricted rights - Use, duplication or disclosure is subject to restrictions set forth in GSA ADP Schedule Contract with IBM Corp.

Contents

Preface	xiii
The team that wrote this redbook	xiii
Comments welcome	xiv
Chapter 1. Printing on the AS/400 system	1
1.1 Output queues: Spooled files	1
1.2 Data streams supported on the AS/400 system	3
1.3 Printer writer	6
1.3.1 Print writer	8
1.3.2 Print Services Facility/400	9
1.3.3 Host print transform	13
1.3.4 Image print transform	14
1.4 AS/400 printer attachment methods	15
1.4.1 Printers attached to AS/400 workstation controllers or IBM 5x94	15
1.4.2 IPDS printers LAN-attached	16
1.4.3 ASCII printers attached to displays	17
1.4.4 ASCII printers attached to PCs	18
1.4.5 ASCII printers LAN-attached	19
1.4.6 Printers attached to PSF Direct	20
1.4.7 Printers attached to PSF/2 DPF	21
1.5 Remote system printing	22
1.6 Printing SCS, IPDS, AFPDS, and USERASCII spooled files	23
1.6.1 SCS spooled files	23
1.6.2 IPDS spooled files	24
1.6.3 AFPDS spooled files	25
1.6.4 USERASCII spooled files	25
1.6.5 USERASCII spooled files with image print transform	26
1.7 Implementing a printing concept	27
1.7.1 Print criticality	27
1.7.2 Print output requirements	27
1.7.3 Printer file device type	27
1.7.4 Writer supporting printer file device type	28
1.7.5 Printer requirements	30
1.7.6 Types of printers	30
1.7.7 Printer attachment methods	32
1.7.8 What must be considered	32
Chapter 2. Advanced Function Presentation	35
2.1 Overview of AFP on the AS/400 system	35
2.1.1 What AFP is	35
2.1.2 AS/400 AFP model	35
2.1.3 APU print model	37
2.1.4 PFU print model	39
2.1.5 Page and form definitions print model	41
2.1.6 AFP toolbox print model	42
2.2 AFP resources	42
2.2.1 Creating AFP resources	43
2.2.2 OEM products	45
2.3 AFP Utilities/400 V4R2 enhancements	45
2.3.1 View electronic form on PC (Overlay Utility)	45
2.3.2 Print Format Utility 'Omit Back Side Page Layout'	47

2.3.3	Element repeat	47
2.3.4	Form definition	47
2.3.5	Tutorial	48
2.3.6	Printer type	48
2.3.7	Host outline font support	48
2.4	Advanced Print Utility (APU) enhancements	49
2.4.1	Duplex	49
2.4.2	Multiple Text Mapping	50
2.4.3	Outline font support	52
2.4.4	Advanced Print Utility (APU) monitor enhancement	52
2.4.5	Print engine	66
Chapter 3. Enhancing your output		67
3.1	How your print output could look	68
3.2	Using Advanced Print Utility (APU)	69
3.2.1	APU environment	69
3.2.2	Setting up APU	69
3.2.3	Creating the print definition	72
3.2.4	Working with the print definition	74
3.2.5	Testing the print definition	79
3.2.6	Printing using the APU monitor	80
3.3	Using the Page Printer Formatting Aid	81
3.3.1	Creating a source physical file for form and page definitions	82
3.3.2	Compiling the form and page definitions	84
3.3.3	Printing with the form and page definitions	86
3.3.4	Considerations	88
3.4	APU versus PPFA	88
Chapter 4. Fonts		89
4.1	Where fonts are stored	89
4.1.1	Printer-resident fonts	89
4.1.2	Host-resident fonts	90
4.2	How fonts are selected	91
4.2.1	Characters per inch (CPI)	92
4.3	Which fonts are available	93
4.3.1	Fonts supplied at no charge	93
4.3.2	240-pel fonts available at a charge	94
4.3.3	300-pel fonts available at a charge	95
4.4	How fonts are installed	96
4.4.1	Making the fonts available	97
4.5	Outline fonts	99
4.5.1	Downloading host-resident outline fonts	100
4.5.2	Why use an outline font	100
4.5.3	Scalable fonts for MULTIUP and COR	101
4.6	Font substitution	101
4.6.1	Suppressing font substitution messages	102
4.7	Font table customization	103
4.7.1	Creating the font tables	103
4.7.2	Adding a font table entry	104
4.7.3	Other font table commands	105
4.7.4	Customer-defined font ranges	106
4.8	Disabling resident font support	106
4.9	Using a resource library list	107

4.10	Font capturing	108
4.10.1	Font resources eligible for capture	108
4.10.2	Marking a font resource	109
4.10.3	Defining the printer for font capture	110
4.10.4	Considerations for font capture	110
4.11	Creating AFP fonts with Type Transformer	110
Chapter 5. The IBM AFP Printer Driver		117
5.1	Overview	117
5.1.1	Why use the AFP Printer Driver	117
5.2	Installing the AFP Printer Driver	118
5.2.1	Installation from the World Wide Web	121
5.3	Creating an overlay	122
5.4	Creating a page segment	126
5.5	Text versus image	129
5.6	Other AFP Printer Driver tasks	130
5.6.1	Using the Images dialog box	130
5.6.2	File transfer of AFP resources using FTP	130
5.6.3	Problem solving	131
5.6.4	Performance of the AFP Printer Driver	134
5.6.5	Creating AFP documents	134
Chapter 6. Host print transform		137
6.1	Host print transform overview	137
6.2	Host print transform enhancements	138
6.3	Host print transform process	139
6.4	Enabling host print transform	140
6.5	SCS to ASCII transform	140
6.6	AFPDS to ASCII transform	142
6.6.1	Mapping mode	143
6.6.2	Raster mode	146
6.6.3	Processing AFP resources	148
6.6.4	Processing AFPDS barcodes	148
6.6.5	How AFPDS to ASCII transform handles a no-print border	149
6.6.6	AFPDS to TIFF	150
6.6.7	Transform spooled file and write to folder	150
6.6.8	AFPDS to ASCII transform limitations	150
6.7	Host print transform customization	151
6.8	New and enhanced tags for WSCST objects	152
6.9	New MFRTYPMDL special values	154
6.10	DBCS support in host print transform	156
6.10.1	DBCS SCS to ASCII transform	156
6.10.2	DBCS AFPDS to ASCII transform	157
6.10.3	New tags and supported data streams for DBCS	157
Chapter 7. Image print transform		161
7.1	Image print transform function	161
7.2	Why use image print transform	162
7.3	Image print transform process	163
7.3.1	Where output attributes are derived	165
7.4	Printing with the image print transform function	165
7.4.1	Printing to an ASCII printer	165
7.4.2	Printing to an IPDS printer	166
7.4.3	Sending the spooled files	166

7.5	Image configuration objects	166
7.5.1	Values of image configuration objects	166
7.6	Printing with the convert image API	168
7.7	Converting PostScript data streams	168
7.7.1	Fonts	168
7.7.2	User-supplied fonts	169
7.7.3	Font substitution	169
7.8	Troubleshooting	170
Chapter 8. Remote system printing		171
8.1	Remote system printing overview	171
8.2	AS/400 system and TCP/IP LPR-LPD printing	172
8.2.1	Creating the output queue	172
8.2.2	Destination options	176
8.2.3	Separator pages	178
8.2.4	'Load Letter' message on the printer	179
8.3	AS/400 and NetWare printing	181
8.3.1	Preparing for remote system printing	182
8.3.2	Creating an output queue	182
Chapter 9. Client Access/400 printing		185
9.1	Client Access/400 printing overview	185
9.2	Client Access/400 Network Printing	186
9.2.1	Configuring an AS/400 printer to Windows 95	186
9.2.2	Network printer setup	191
9.2.3	AS/400 print profile	191
9.2.4	Considerations on Client Access/400 Network Printing	193
9.3	Printing AS/400 output on a PC printer	194
9.3.1	Configuring a printer emulation session	194
9.3.2	Modifying and using a printer definition table (PDT)	200
Chapter 10. IBM AS/400 network printers		205
10.1	Overview	205
10.2	Configuration scenarios	206
10.2.1	Example 1: LAN-attached IPDS printer	206
10.2.2	Example 2: Dual-configuration printer	207
10.2.3	Example 3: Shared dual-configuration printer	207
10.2.4	Example 4: Shared multi-purpose printer	208
10.3	Printer setup	209
10.3.1	Printer menu details	209
10.3.2	Recommended PTF levels	212
10.3.3	Microcode	212
10.3.4	Tray and bin selection	212
10.4	Attachment information	215
10.4.1	Network Printer Manager	215
10.5	Output presentation	216
10.5.1	IPDS, AFP=*YES	216
10.5.2	IPDS, AFP=*NO	216
10.5.3	SCS mode	216
10.5.4	Using the QPRTVALS data area	217
10.5.5	Using the IPDS menu PAGE setting	218
10.5.6	Edge-to-edge printing	221

Chapter 11. Configuring LAN-attached printers	223
11.1 Configuring LAN-attached IPDS printers	223
11.1.1 Configuring LAN-attached IPDS printers on V3R2	224
11.1.2 Configuring LAN-attached IPDS printers on V3R7 and later	230
11.1.3 TCP/IP BOOT service for V4R1 and later	237
11.2 Configuring LAN-attached ASCII printers	238
11.2.1 Configuring LAN-attached ASCII printers using LexLink	238
11.2.2 Configuring LAN-attached ASCII printers using PJI drivers.	241
11.2.3 Configuring LAN-attached ASCII printers using SNMP drivers.	246
Chapter 12. Problem determination techniques	253
12.1 Communication, connection, and configuration problems	253
12.1.1 Setting up a TCP/IP network on the AS/400 system	253
12.1.2 SSAP values in the line description	253
12.1.3 Pinging the TCP/IP address	254
12.1.4 Port number	254
12.1.5 Print Job Language (PJI) support	255
12.1.6 Message PQT3603	255
12.1.7 Configuring LAN-attached IPDS printers	257
12.1.8 Configuring for remote system printing	258
12.1.9 Remote printer queue names	258
12.2 Printer-writer-related problems	259
12.2.1 Print writer ends	259
12.2.2 Spooled files remain in RDY status	260
12.2.3 Spooled file remains in PND status	261
12.2.4 Ending the writer	261
12.2.5 Spooled file status.	262
12.2.6 Output queue status	263
12.2.7 AFCCU printers: Minimize delay when stopping and starting.	264
12.2.8 QSTRUP execution during IPL	264
12.3 Where your print output goes	265
12.4 Spooled file goes to hold status	266
12.4.1 Writer cannot re-direct the spooled file	267
12.4.2 Message PQT3630	268
12.4.3 Fidelity parameter	269
12.5 Copying spooled files	269
12.6 Problem with output presentation	271
12.6.1 Physical page: Logical page	271
12.6.2 Printer setup	273
12.6.3 Computer Output Reduction	273
12.6.4 A3 page support	274
12.7 Font problems	274
12.7.1 Problems with shading at different resolutions.	276
12.8 Drawer and paper path selection problems	276
12.8.1 IBM 4247 paper path selection	276
12.9 Printing on ASCII printers	277
12.10 Additional information	278
Appendix A. PSF/400 performance factors	279
A.1 AS/400 system storage	279
A.2 Data stream type	280
A.2.1 IPDS pass through	282
A.2.2 Printer device description parameters.	282

A.3	AFP resource retention	282
A.3.1	Clear memory for security	283
A.4	Font types	283
A.4.1	Using GDDM fonts	283
A.5	Library list searches	284
A.6	Creating efficient AFP resources	284
A.7	Other factors	285
A.7.1	PSF configuration object parameters	285
A.7.2	Printer file parameters	285
A.7.3	Printer settings	285
Appendix B. Data Description Specifications (DDS) formatting		287
B.1	DDS functionality example	287
B.2	Super Sun Seeds invoicing example	292
Appendix C. Print openness		303
C.1	Additional functions provided on the printer file	304
C.2	Additional functions provided on the PRTDEV commands	304
C.3	Additional functions provided on the output queue commands	305
C.4	Additional functions	306
C.5	Print openness: New APIs	306
Appendix D. Network Station printing		309
D.1	Printing from OS/400	309
D.1.1	AS/400 Network Station printer driver	309
D.1.2	Creating printer device descriptions	309
D.2	Local printing	311
D.2.1	5250 screen copy to a local printer	311
D.2.2	Printing from Java	311
Appendix E. Printer summary		313
Appendix F. PSF/400 performance results		317
F.1	Environment	317
F.1.1	Software	317
F.1.2	Hardware	318
F.2	Methodology	318
F.3	Performance cases	319
F.4	Results	322
F.4.1	PSF/400 V4R2 with Network Printer 24	322
F.4.2	PSF/400 V4R2 with IP60	323
F.4.3	PSF/400 V4R2 with IP4000	325
F.4.4	Comparison: Printing rates using PSF/400 V4R2 on Model 510/2144	326
F.4.5	Comparison of processor requirements	328
F.4.6	Predictions of processor utilizations at printing speeds	329
F.4.7	Print While Convert (PWC)=Yes compared to PWC=NO	331
F.5	Application of results	332
F.6	Sample output	333
Appendix G. Advanced Print Utility implementation case study		343
G.1	Ordering printers	343
G.1.1	Low-end printer: IBM Network Printer 12	343
G.1.2	Departmental printer: IBM Infoprint 21	343
G.1.3	AS/400 production printer and PC LAN departmental printer	344

G.2	Ordering and obtaining software	345
G.2.1	Checking whether the software is already installed	345
G.3	Installing the software	348
G.3.1	PSF/400	348
G.3.2	AFP Utilities/400	348
G.3.3	AFP Font Collection	348
G.3.4	Advanced Print Utility	350
G.3.5	Additional steps that may be required	350
G.4	Designing electronic documents	351
G.4.1	Which fonts to use	352
G.5	Creating the resources	352
G.6	Building and testing APU print definitions	354
G.6.1	Other common problems	356
G.6.2	Viewing APU output	357
G.7	Automatically starting the APU Monitor	358
G.7.1	Creating a separate APU subsystem	358
G.7.2	Modifying QBATCH to allow multiple jobs to run	360
G.8	Using APU for production printing	360
G.8.1	Using APU Monitor Actions	360
G.9	Documentation	365
G.9.1	Documenting APU component names	365
G.9.2	Where APU print components are stored	366
Appendix H. AS/400 to AIX printing		367
H.1	TCP/IP versus SNA	367
H.1.1	Sending spooled files using TCP/IP	367
H.1.2	PSF Direct	370
H.2	AS/400 spooled file data streams	372
H.2.1	*SCS	372
H.2.2	OV/400 and Final Form Text	374
H.2.3	*AFPDS	374
H.2.4	*IPDS	375
H.2.5	*LINE or *AFPDSLIN	375
H.2.6	*USERASCII	375
H.3	Automating the process	376
H.3.1	Default Document	376
H.3.2	Destination options in the remote output queue	377
H.3.3	Output queue monitor	377
H.4	Special considerations	378
H.4.1	Processing line AS/400 SCS files as 'flat ASCII'	378
H.4.2	Sample page and form definition for STD132	379
H.4.3	Parmdd file	380
H.4.4	Destination Options	381
H.4.5	Output from the AS/400 query	382
H.4.6	Transferring resources	382
H.4.7	Large spooled files	383
H.5	Case studies	383
H.5.1	One printer, all AFPDS	383
H.5.2	One printer, four document types	384
H.5.3	70 printers, 12 applications, SCS spooled files	384
H.5.4	Multiple printers, many data streams	384
H.6	Sending AS/400 spooled files to OnDemand for UNIX	385
H.6.1	AS/400 side tasks	385

H.6.2 AIX side tasks	385
H.7 AS/400 printing to an Infoprint Manager for Windows NT or 2000 server . . .	385
H.7.1 Hypothetical case studies	386
H.8 Additional references	387
Appendix I. Infoprint 2000 printing considerations	389
I.1 Print file considerations and HPT formatting	389
I.2 Infoprint Manager and other solutions	390
I.2.1 Another application solution	392
I.2.2 Operator considerations	393
Appendix J. Printing enhancements in recent OS/400 releases	395
J.1 Version 4 Release 5	395
J.1.1 SNMP ASCII printer driver	395
J.1.2 SNMP driver for Infoprint 21	395
J.1.3 PSF/400 printer ranges	396
J.1.4 AFP Font Collection bundled with PSF/400	396
J.1.5 Type Transformer for Windows	396
J.1.6 AFP/IPDS support for OneWorld	396
J.2 Version 4 Release 4	396
J.2.1 Simplex/duplex mode switching DDS	397
J.2.2 Force new sheet DDS	397
J.2.3 Output bin DDS	397
J.2.4 Insert DDS	397
J.2.5 Z-fold DDS	397
J.2.6 Overlay rotation DDS	397
J.2.7 Constant back overlay in the printer file	397
J.2.8 Print finishing	398
J.2.9 AS/400 font management	398
J.2.10 Advanced Function Printing Utilities (AFPU) enhancements	398
J.2.11 Content Manager OnDemand for AS/400	398
J.3 OS/400 Version 4 Release 3	398
J.3.1 Integration of AFP Workbench into Client Access/400	399
J.3.2 Indexing keyword in DDS	399
J.3.3 Support for line data enhanced	399
J.3.4 Automatic resolution enhancement	399
J.3.5 Font performance improvement	400
J.3.6 Sizing and rotating page segments	400
J.3.7 Enhanced PostScript transform	400
J.3.8 IPDS pass through	400
J.3.9 AFP Font Collection with Euro, expanded languages	400
J.3.10 AFP PrintSuite for AS/400	401
J.4 OS/400 Version 4 Release 2	401
J.4.1 OS/400 Image Print Transform Services	401
J.4.2 Support for outline fonts	402
J.4.3 Font capture	402
J.4.4 Cut-sheet emulation	402
J.4.5 Finishing support	403
J.4.6 TCP/IP configuration enhancements	403
J.4.7 Font substitution messages	403
J.4.8 AFP Utilities for V4R2	403
Appendix K. Using the additional material	405
K.1 Locating the additional material on the Internet	405

K.2 Using the Web material	405
K.2.1 How to use the Web material	405
Appendix L. Special notices	407
Appendix M. Related publications	411
M.1 IBM Redbooks	411
M.2 IBM Redbooks collections	411
M.3 Other resources	411
M.4 Referenced Web sites	413
How to get IBM Redbooks	415
IBM Redbooks fax order form	416
Index	417
IBM Redbooks review	425

Preface

This IBM Redbook describes how to use printing functions on the AS/400 system. It supplements the standard reference documents on AS/400 printing by providing more specific “how to” information, such as diagrams, programming samples, and working examples. It addresses the printing function found in OS/400, Print Services Facility/400 (PSF/400), Advanced Print Utility, Page Printer Formatting Aid, AFP Font Collection, and other print-enabling software. The original edition applied to Version 3 Release 2 for CISC systems and Version 4 Release 2 for RISC systems. This second edition includes information about the new functions that are available in releases up to and including Version 4 Release 5.

This document is intended for customers, business partners, and IBM systems specialists who need to understand the fundamentals of printing on the AS/400 system. It is designed to help you develop or advise others concerning the design and development of AS/400 printing applications.

This document is not intended to replace existing AS/400 printing publications, but rather to expand on them by providing detailed information and examples.

The team that wrote this redbook

This redbook was produced by a team of specialists from around the world working at the International Technical Support Organization Rochester Center.

Alain Badan is an Advisory IT Specialist in Switzerland. His areas of expertise include AS/400 printing and AS/400 Facsimile Support/400. Alain has written other redbooks on AS/400 Printing and Facsimile Support/400.

Simon Hodkin is a Senior IT Specialist in the U.K. Printing Systems Business. He has worked at IBM for 12 years. He has devised and run classes on printer connectivity and AFP. During the last three years, Simon has designed and implemented AS/400 printing solutions for major U.K. customers.

Jacques Hofstetter is a Systems Engineer in Switzerland. He has 10 years of experience in AS/400 printing, and has worked at IBM for 15 years. His areas of expertise include Advanced Function Presentation and AS/400 printing.

Gerhard Kutschera is a Systems Engineer Specialist in Austria. He has 11 years of experience with the AS/400 system, and has worked at IBM for 21 years. His areas of expertise include printing on the AS/400 system and AFP printing on RS/6000. Gerhard has also written another redbook on OfficeVision/400 printing.

Whit Smith is an Education Specialist in the U.S. He has worked at IBM for eight years, after several years as an IBM customer. He holds a degree in Computer Science from the University of Texas. His areas of expertise include Communications, Application Development, and System Management.

The October 2000 revision of the *IBM AS/400 Printing V* redbook was a result of the contributions of:

Mike McDonald
Bill Shaffer
IBM Boulder

Roger Drolet
Mira Shnier
IBM Canada

Simon Hodkin
IBM United Kingdom

Thanks to the following people for their invaluable contributions to the first edition of this redbook:

Nick Hutt
ITSO Rochester

Russ Dickson
Ken Dittrich
Karl Hanson
Dave Murray
Ted Tiemens
Kevin Vette
IBM Rochester

Tim Aden
Jack Klarfeld
Bruce Lahman
Robert Muir
Brian Pendleton
Dale Pirie
Bill Shaffer
Bob Stutzman
Nancy Wood
IBM Boulder

Eddy Gauthier
IBM Belgium

Mira Shnier
IBM Canada

Comments welcome

Your comments are important to us!

We want our Redbooks to be as helpful as possible. Please send us your comments about this or other Redbooks in one of the following ways:

- Fax the evaluation form found in “IBM Redbooks review” on page 425 to the fax number shown on the form.
- Use the online evaluation form found at ibm.com/redbooks
- Send your comments in an Internet note to redbook@us.ibm.com

Chapter 1. Printing on the AS/400 system

We can define and view printing in a simplified manner: something to print, a program to pass the information to a printer, and a printer (and some paper).

The same sentence translated into AS/400 printing terminology results in: An application creates a spooled file; the data is from the application and the spooled file attributes (page size, number of copies, default font, and so on) are from the printer file associated with the application. The spooled file is placed into an output queue; a print writer program then passes the spooled file to the printer to print it. The print writer also takes information from the printer device description. Figure 1 shows the basic AS/400 printing elements.

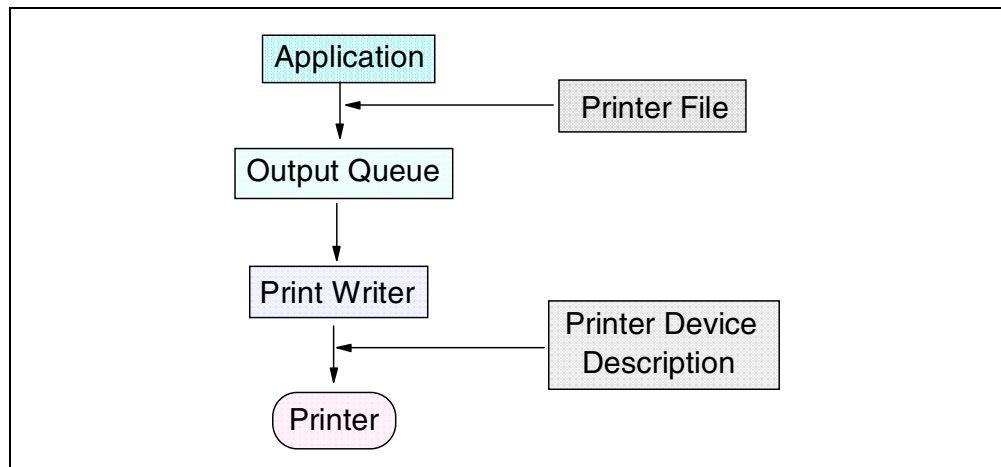

Figure 1. Basic AS/400 printing elements

The objectives of this chapter are to explain how printing works and to show all the printing possibilities with AS/400 systems.

1.1 Output queues: Spooled files

The spooled files stored in output queues can have different origins and different formats (data streams) (Figure 2 on page 2), for example:

- Spooled files can be created on the AS/400 system by an application, by OfficeVision/400, or just by a print screen.
- With Client Access/400, the network printing function (previously named virtual printing) can direct PC output to an AS/400 output queue.
- You may also receive spooled files from host systems (IBM S/390), RISC systems (IBM RS/6000), or OEM systems.

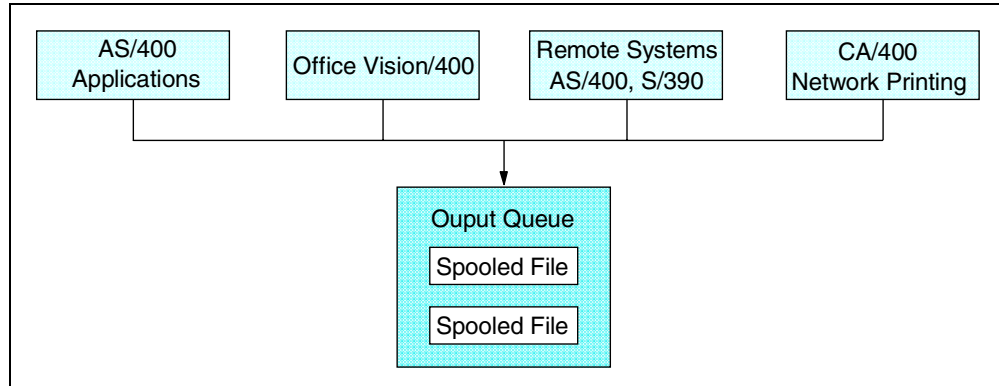

Figure 2. AS/400 spooled files

On the AS/400 system, many commands are available for controlling printing activities. Some of the commands are:

WRKSPLF The Work with Spooled Files display shows all (or a specific portion) of the spooled files that are currently on the system. The display includes information such as file and user names, device or queue names, status, and total pages.

From this display, options are available to send, view, and change the attributes and hold, delete, display, and release the spooled files.

Function keys are also available to change the assistance level, select another view, or to display all the printers configured to the system with the status of their associated print writers.

WRKOUTQ The Work with Output Queue display shows all the files on the specified queue. The display includes information such as file and user names, status, total pages, and number of copies.

From this display, you can select an option to send, view, and change the attributes as well as hold, delete, display, and release the spooled files.

Function keys are also available to change the assistance level, select another view, display information on the writer associated with the output queue, or display all the printers configured to the system with the status of their associated print writers.

WRKSPLFA The Work with Spooled File Attributes command shows the current attributes of the specified spooled file. It is possible to obtain the same display by selecting option 8 (Attributes) from the Work with Spooled Files or Work with Output Queue display.

The spooled file attributes are information concerning a spooled file such as status, output queue, printer device type, page size, font, rotation, character identifier, and number of copies.

CHSPLFA The Change Spooled File Attributes command allows you to change the attributes of a spooled file while it is on an output

queue. The same display is received by selecting option 2 (Change) in the Work with Spooled Files or Work with Output Queue display.

Depending on the spooled file printer device type (or data stream), you may be able to change some of the attributes. For example, you can change the overlay if the printer file has a device type *SCS, but you cannot if it is *AFPDS. This is because the overlay is referenced in the spooled file data and not as an attribute for *AFPDS.

- STRPRTWTR** The Start Print Writer command starts a spooling writer to the specified printer. This command specifies the name of the printer, the names of the output queue and message queue used, and the name of the writer.
- ENDWTR** The End Writer command ends the specified spooling writer and makes this associated output device available to the system. The writer can be ended immediately or in a controlled manner.
- WRKCFGSTS** The Work with Configuration Status command is used to display and to work with configuration status functions. A command parameter allows you to specify the type of description for which you want the status to be shown. For example, for printer descriptions, select *DEV (devices), and also specify the configuration description name, a generic name, or *ALL.

Options on the Work with Configuration Status display allow you to vary on or off the device and display or change the device description.

For detailed information on these commands and on printer files, see *AS/400 Printer Device Programming*. Refer to M.3, "Other resources" on page 411, for the form number based on the version and release level of the OS/400.

1.2 Data streams supported on the AS/400 system

The printed output is the result of the interaction between the printer itself and the controlling software.

Because there are different requirements for print output and different types of printers (line mode, page mode), there is also different software (data streams) (Figure 3 on page 4).

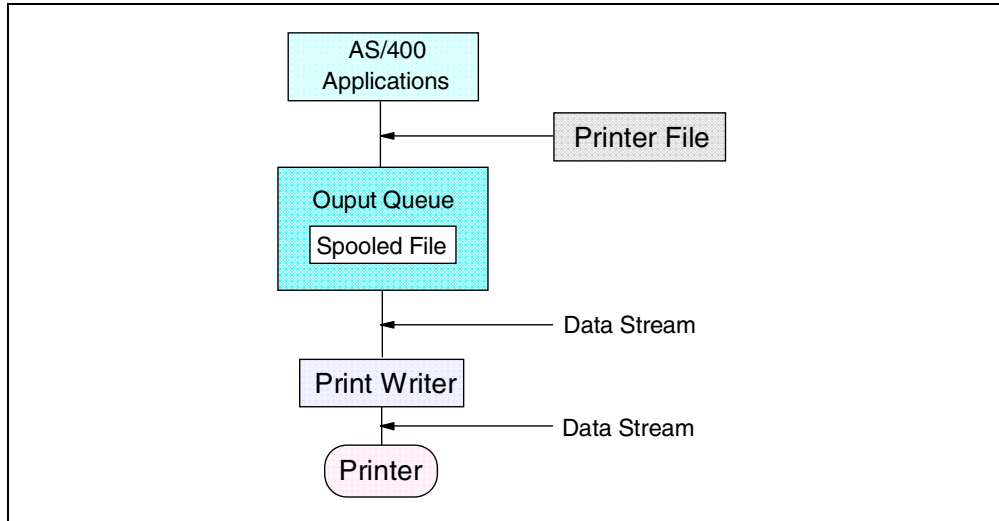

Figure 3. Data stream

The AS/400 system supports different data streams and can automatically create the majority of them. The Printer device type parameter (Figure 4) in the printer file determines the type of data stream to be created.

```

Create Printer File (CRTPRTF)
Type choices, press Enter.

File . . . . . > MYPRTF      Name
Library . . . . . > MYLIB    Name, *CURLIB
Source file . . . . . *NONE   Name, *NONE
Library . . . . .           Name, *LIBL, *CURLIB
Source member . . . . . *FILE  Name, *FILE
Generation severity level . . . 20      0-30
Flagging severity level . . . . 0      0-30
Device:
Printer . . . . . *JOB        Name, *JOB, *SYSVAL
Printer device type . . . . . *SCS      *SCS, *IPDS, *LINE...
Text 'description' . . . . . *SRCMBRTXT

Bottom
F3=Exit  F4=Prompt  F5=Refresh  F10=Additional parameters  F12=Cancel
F13=How to use this display  F24=More keys
  
```

Figure 4. Create Printer File: Printer device type parameter

The Printer device type parameter can be set to one of the following values:

- ***SCS** (SNA Character String):
Used to control line mode printers and has a relatively simple structure. The Data Description Specifications (DDS) FONT keyword is not supported. The font specified in the printer file or the printer default font is used.
An extension of SCS, FFT-DCA (Final-Form Text Document Architecture) is used within the AS/400 Office environment.
- ***IPDS** (Intelligent Printer Data Stream):
A host-to-printer data stream used for AFP subsystems. It provides an attachment-independent interface for controlling and managing

all-point-addressable (APA) printers. It supports interactive, two-way dialog between the print driver and the printer (printer information, cooperative recovery, and resources management).

Note: The AS/400 generated IPDS is a subset of the full IPDS. For detailed information, see 1.3, “Printer writer” on page 6.

- ***AFPDS** (Advanced Function Printing Data Stream):

A data stream for advanced function printers (independent of operating systems, independent of page printers, and portable across environments). AFPDS is a structured data stream divided into components called *objects*. AFPDS includes text, images, graphics, and barcodes and references AFP resources (for example, overlays, page segments, and fonts).

- ***LINE** (Line data stream):

A LINE data stream referencing a page definition and a form definition with the spooled file. The printer file device type parameter was enhanced in V3R2 and V3R7 (and later) with a new value *LINE.

- ***AFPDSL**INE: AFPDS line (also called Mixed) data stream:

AFPDSL

INE data stream is a mixture of AFP structured fields and LINE data. Only certain AFP structured fields can be mixed with the line data. Programmers must specify AFP structured fields in applications. The printer file device type parameter was enhanced in V3R2 and V3R7 (and later) with a new value *AFPDSL

INE.

- ***USERASCII**: ASCII data stream:

There is no formal structure controlling the use of the American National Standard Code for Information Interchange (ASCII) data stream to control printers attached to systems providing ASCII support. There is no architectural data stream standard to which ASCII printers can conform in the interest of uniformity.

To create a spooled file in *USERASCII on the AS/400 system, programmers must specify ASCII escape sequences in applications using the transparency mode. We do not recommend this approach because the escape sequences required in the application depend on the type of printer.

A *USERASCII spooled file can contain any form of ASCII printer data stream (for example, PCL5, PPDS, or PostScript).

Spooled files can also be received from other systems:

- From another AS/400 system, you can receive spooled files in SCS, IPDS, LINE, AFPDSL

INE, AFPDS, or USERASCII data streams.

- If the spooled file is from a System/390, LINE, AFPDSL

INE, and AFPDS are supported. By using object distribution (SNADS), the spooled file is placed directly in an AS/400 output queue.

- From a PC running Client Access/400 network printing, you can receive spooled files in SCS, AFPDS, or USERASCII.
- From a RISC system (RS/6000), you may receive spooled files in AFPDS or USERASCII.
- From an Other Equipment Manufacturer (OEM) system, spooled files are normally received in USERASCII.

A spooled file stored in an AS/400 output queue can be in different data streams. On the other end, many printers support only one data stream (for example SCS, IPDS, or ASCII PCL5). Some others (for example, the IBM Infoprint 20, 21, 32, and 40) support IPDS, PCL, and Postscript. Figure 5 shows data streams and printer devices.

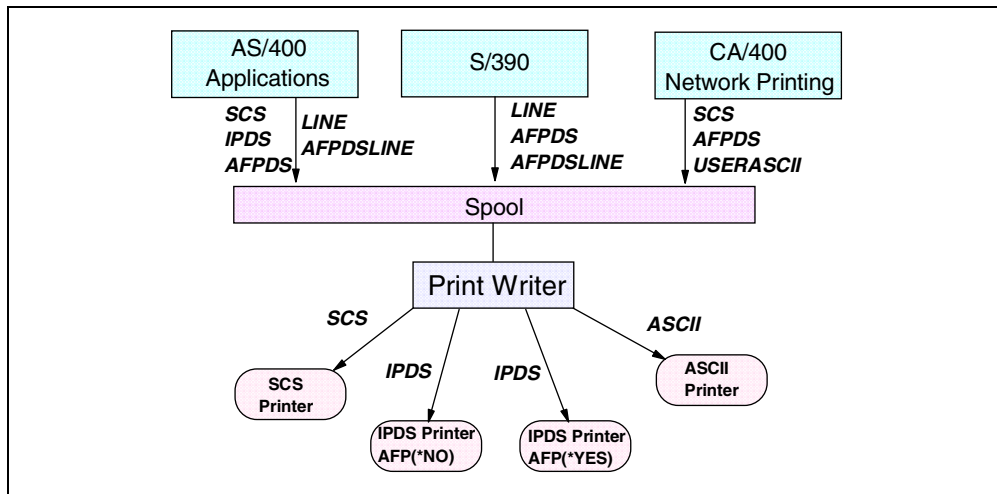

Figure 5. Data streams and printer devices

On the AS/400 system, the print writer can convert some of the data streams to others. The following section explains the possible conversions.

1.3 Printer writer

The printer writer program is a system-supplied program. This program takes the spooled file from an output queue and sends it to a printer. The printer writer handles spooled files by using one of the following options:

- Print Writer
- Print Services Facility/400 (PSF/400)
- Host print transform

Each of these writer options supports different data streams and printer types. They can also perform certain data stream conversions.

Figure 6 shows the three options with the supported input data streams, the resulting data streams, and the required printer types.

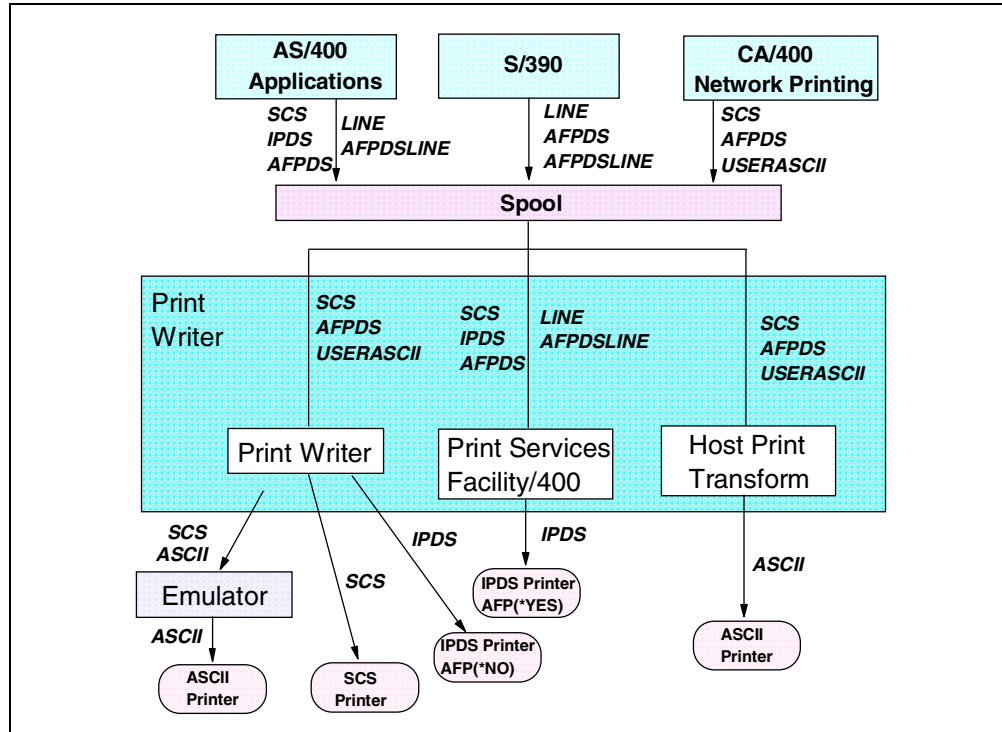

Figure 6. Printer writer and data streams

The IPDS data stream generated by the AS/400 system (when the printer file device type parameter is set to *IPDS) is not the full IPDS data stream. Many functions are not included in this subset, including the use of external resources such as fonts or page segments.

The IPDS data stream generated by Print Services Facility/400 (PSF/400) includes the full IPDS set of commands and supports a two-way dialog between PSF/400 and the printer (Figure 7).

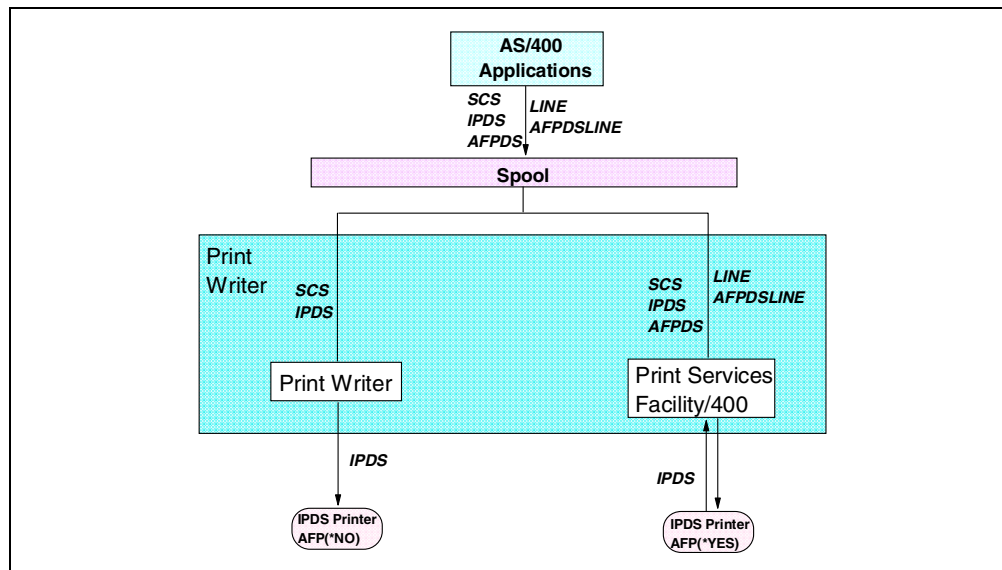

Figure 7. AS/400 generated IPDS: Full IPDS

The AS/400-generated IPDS is supported by the print writer or transformed to full IPDS by PSF/400. AS/400-generated IPDS cannot be transformed to an ASCII data stream and can only be sent to another AS/400 system. For more information, see 1.6.2, “IPDS spooled files” on page 24. Because of these restrictions, we recommend using device type *AFPDS in place of *IPDS in the printer file to allow portability, more conversion possibilities, and full IPDS support.

1.3.1 Print writer

The print writer (Figure 8) is used when the target printers are SCS, IPDS configured with the Advanced Function Printing (AFP) parameter set to *NO, or ASCII using an emulator.

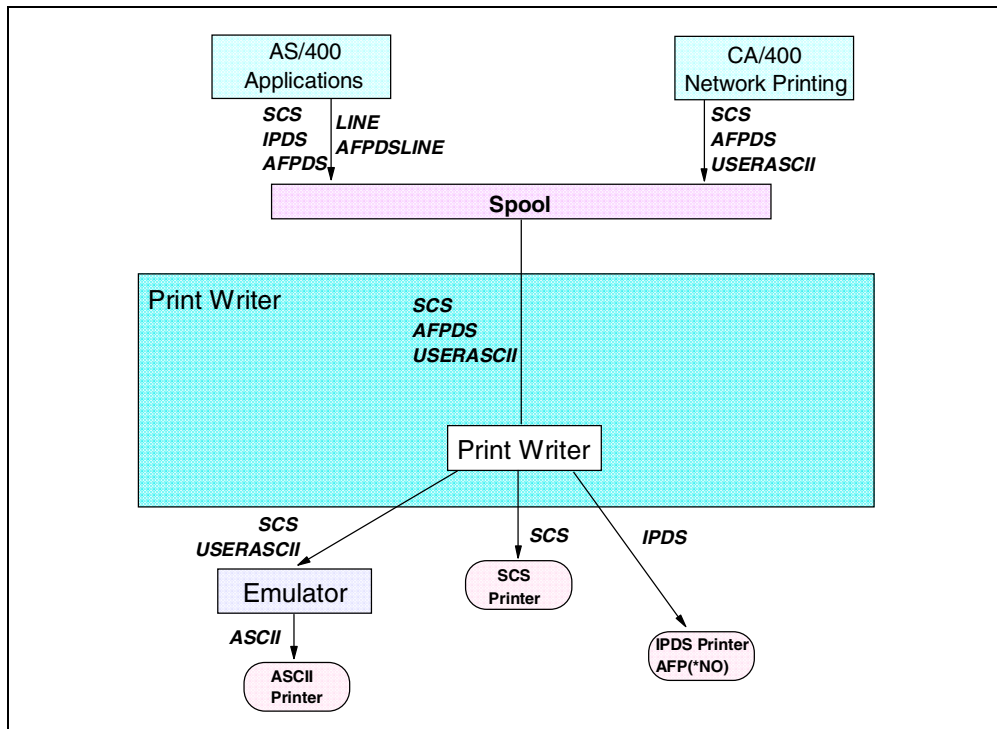

Figure 8. Print writer

When printing using the print writer, you have to consider these points:

- If the spooled file data stream is SCS and the target printer is an IPDS AFP(*NO) printer, the data stream is transformed by the print writer into IPDS.
- If the spooled file data stream is IPDS, AFPDS, or AFPDSLNE and the target printer is SCS or ASCII using an emulator, an error message is returned.
- If the spooled file data stream is AFPDS or AFPDSLNE and the target printer is IPDS AFP(*NO), an error message is returned.
- If the spooled file data stream is LINE and refers to a PAGDFN (page definition) and the target printer is SCS or IPDS AFP(*NO), an error message is returned.
- If the spooled file data stream is LINE and refers to FORMDF (form definition) but no PAGDFN (page definition) and the target printer is SCS or IPDS AFP(*NO), the spooled file will print, but the FORMDF parameter is ignored.

- If the spooled file data stream is USERASCII, the target printer must be an ASCII printer using an emulator.
- If the target printer is an ASCII printer using an emulator, only SCS and USERASCII spooled files are supported.

Note: The USERASCII spooled files must be in an ASCII printer data stream supported by the target printer (for example, PCL5, PPDS, or PostScript).

- There is no support for overlays, page segments, or downloaded fonts.
- Barcodes are supported only on IPDS printers (even configured AFP(*NO)).
- An image can only be printed from OfficeVision/400 and the target printer must be IPDS (even configured AFP(*NO)).

1.3.2 Print Services Facility/400

Implementation of the AFP print subsystem was added to OS/400 in V1R2 (1989) as an integrated component of the operating system. OS/400 Version 2 was enhanced in subsequent releases to provide AFP print subsystem support similar to that in S/390. From OS/400 Version 2, there are two separate printing subsystems in the operating system. OS/400 native print support (print writer) continues to support line printers and a subset of IBM IPDS printers and print functions. Full support for all IPDS printers is provided by the integrated AFP printing subsystem. Which printing subsystem is used to process application output is determined by the device description of the target printer. Only printers defined as IPDS AFP=*YES are controlled by the AFP printing subsystem.

Beginning with OS/400 V3R1, the AFP printing subsystem is a separately orderable feature of OS/400 called Print Services Facility/400.

This feature is licensed according to the speed in impressions per minute (IPM) of the fastest AFP printer used on the system. The number of AFP printers on the system is not relevant, only the speed of the fastest printer. There is also a separate feature for Facsimile Support/400. The four PSF/400 features are:

- PSF/400 Facsimile Support Only
- PSF/400 1-28 IPM Printer Support
- PSF/400 1-45 IPM Printer Support
- PSF/400 Anyspeed Printer Support

1.3.2.1 When PSF/400 is required

Print Services Facility/400 is required when the AS/400 system must support AFP page functionality or IPDS print management. In simple terms, this is whenever the device type in the printer description is *AFPDS. *AFPDS must be specified in the printer device description in the following situations:

- Any time you are printing to a LAN-attached IPDS printer
- Any time you are printing to an Advanced Function Common Control Unit (AFCCU) printer
- Any time you require AFP resource management, for example download and management of fonts, images, overlays, and graphic resources
- Printing to IPDS or ASCII printers attached to Print Services Facility/2
- Printing any AFPDS or line data spooled file to an IPDS printer
- Using Facsimile Support/400 to send faxes

Note: PSF/400 is not required when using the IBM 7852-400 modem as a fax controller.

Examples of AFCCU printers include:

- IBM 3130 Advanced Function Printer
- IBM 3160 Advanced Function Printer
- IBM Infoprint 60 Advanced Function Printer
- IBM Infoprint 62 Advanced Function Printer
- IBM Infoprint 3000 Advanced Printing System
- IBM Infoprint 4000 Advanced Printing System
- Older IBM AFCCU printers, such as the 3820, 3825, 3827, 3828, 3835, 3900, and 3935

The following IPDS printers can be supported without PSF/400 (but PSF/400 may be desirable):

- IBM 4230 Impact Matrix Printer
- IBM 4247 Multiform Impact Printer
- IBM 6400 Line Matrix Printer
- IBM Network Printer (4312)
- IBM Network Printer 17 (4317)
- IBM Infoprint 20 (4320)
- IBM Infoprint 21 (4321)
- IBM Network Printer 24 (4324)
- IBM Infoprint 32 (4332)
- IBM Infoprint 40 (4332)
- Older IBM AS/400 laser printers, such as the 4028, 3112, 3116, 3912, 3916, and 3930 printers

Note: If any of the printers listed here are LAN-attached or require AFP functionality (for example: resource management), PSF/400 changes from optional to required.

1.3.2.2 The Print Services Facility/400 process

PSF/400 provides data stream transforms and AFP print resource management to ensure that applications and their AFP resources print consistently on all printers managed by PSF/400. PSF/400 can transform and print the following data streams on the AS/400 system:

- AFPDS
- SCS
- IPDS
- LINE
- AFPDSL

Note: In V4R2 with the image print function, Tag Image File Format (TIFF), Graphics Interchange Format (GIF), OS/2 and Windows Bitmap (BMP), and PostScript level 1 data streams can also be transformed to be printed on IPDS printers. For an overview on the image print transform, see 1.3.4, “Image print transform” on page 14. For detailed information, see Chapter 7, “Image print transform” on page 161. The Print Services Facility/400 process is shown in Figure 9.

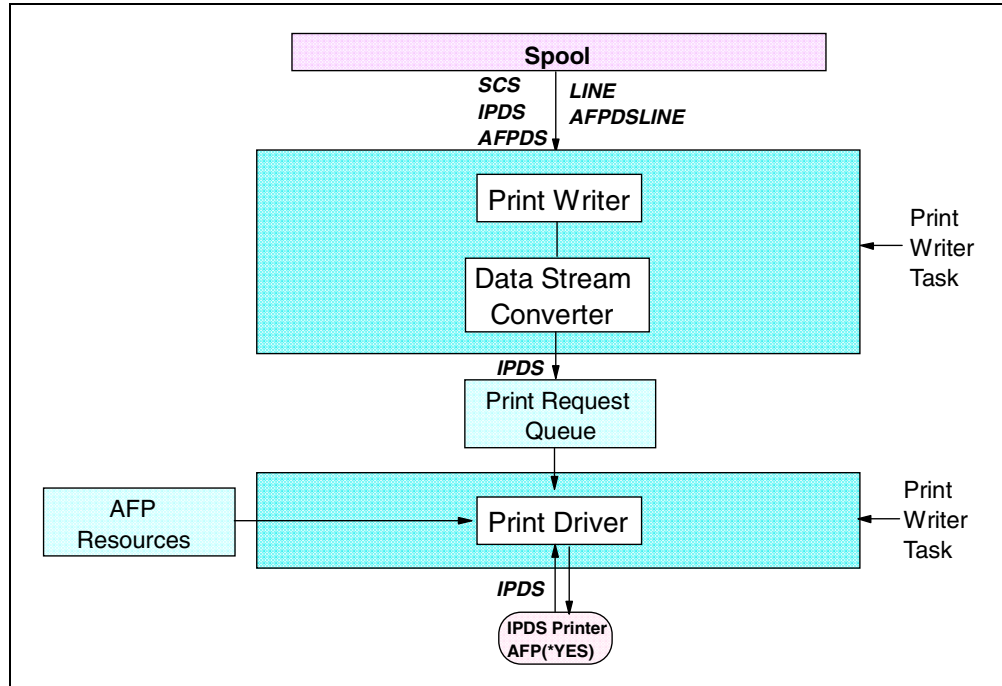

Figure 9. Print Services Facility/400 process

PSF/400 combines application output with print resources such as electronic forms, fonts, page segments, and formatting definitions that are either included inline with the print output or in the AS/400 system libraries. PSF/400 then creates IPDS output for the target IPDS printer configured AFP(*YES).

PSF/400 includes two tasks: the print writer task and the print driver task. The print writer is responsible for the data stream conversion, and the print driver task manages the AFP resources and passes the data to the printer.

Printer files and data description specifications are the user and application program interfaces for print formatting on the AS/400 system, and are included with the operating system. Access to some AFP capabilities, such as electronic forms (overlays), downloading fonts to a printer from host font libraries (including image page segments in a document), and others, have been incorporated into these familiar AS/400 print interfaces for users and application programs.

For more information on Advanced Function Presentation (AFP), see Chapter 2, “Advanced Function Presentation” on page 35. To enhance an existing application producing output in SCS data stream to AFP, see Chapter 3, “Enhancing your output” on page 67.

1.3.2.3 Is PSF/400 installed

To check if the Print Services Facility is installed on your system, type `GO LICPGM` on any command line. The display shown in Figure 10 on page 12 appears.

```

LICPGM                                Work with Licensed Programs                                System:  SYS00005

Select one of the following:
Manual Install
  1. Install all

Preparation
  5. Prepare for install

Licensed Programs
  10. Display installed licensed programs
  11. Install licensed programs
  12. Delete licensed programs
  13. Save licensed programs

Selection or command
====> 10
F3=Exit  F4=Prompt  F9=Retrieve  F12=Cancel  F13=Information Assistant
F16=AS/400 Main menu
(C) COPYRIGHT IBM CORP. 1980, 1998.

```

Figure 10. Work with Licensed Programs

Select option **10** (Display installed licensed program), and press the Enter key. The display shown in Figure 11 appears.

```

                                Display Installed Licensed Programs                                System:  SYS00005

Licensed  Installed
Program  Status      Description
5769SS1  *COMPATIBLE OS/400 - Library QGPL
5769SS1  *COMPATIBLE OS/400 - Library QUSRSYS
5769SS1  *COMPATIBLE Operating System/400
5769SS1  *COMPATIBLE OS/400 - Extended Base Support
5769SS1  *COMPATIBLE OS/400 - Online Information
.....
5769SS1  *COMPATIBLE OS/400 - AFP Compatibility Fonts
5769SS1  *COMPATIBLE OS/400 - *PRV CL Compiler Support
5769SS1  *COMPATIBLE OS/400 - Common Programming APIs Toolkit
5769SS1  *COMPATIBLE OS/400 - Print Services Facility
5769SS1  *COMPATIBLE OS/400 - Media and Storage Extensions
5769SS1  *COMPATIBLE OS/400 - SOMobjects
5769SS1  *COMPATIBLE OS/400 - Advanced 36
5769SS1  *COMPATIBLE OS/400 - Locale Source Library

More...

```

Figure 11. Display Installed Licensed Programs

To see the entry for the Print Services Facility, you may have to page down (press the Page Down key).

Note: For V3R1 and V3R2, the licensed program number is 5763-SS1; for V3R6 and V3R7, the licensed program number is 5716-SS1; and for V4R1 and V4R2, the licensed program number is 5769-SS1.

If the Print Services Facility feature is not present, you must install it. If you have not purchased the PSF/400 feature, contact your IBM representative.

Note: Beginning with OS/400 V4R4, license management of PSF/400 (as with all major OS/400 software) is via license keys. The stacked CD shipped with the release includes PSF/400. PSF/400 can be installed for a trial period of up to 70 days. This trial period begins when you start the first print writer defined as AFP(*YES). At the end of the 70-day period, PSF/400 will stop functioning (unless the license key has been installed).

1.3.3 Host print transform

The host print transform function allows SCS-to-ASCII and AFPDS-to-ASCII conversion to take place on the AS/400 system instead of by the emulators. SCS or AFPDS spooled files converted to ASCII data stream can be directed to ASCII printers.

Note: In V4R2 with the image print function, Tag Image File Format (TIFF), Graphics Interchange Format (GIF), OS/2 and Windows Bitmap (BMP), and PostScript level 1 data streams can also be transformed to be printed on ASCII printers. For an overview of image print transform, see 1.3.4, “Image print transform” on page 14. For detailed information, see Chapter 7, “Image print transform” on page 161.

Host print transform converts the SCS data stream or the AFPDS data stream just before it is sent to the ASCII printer. The spooled file contains SCS data or AFPDS data and not the converted ASCII data.

AFP resources (such as character sets, overlays, and page segments) referenced in AFPDS spooled files are converted into ASCII data streams and passed to the ASCII printer.

Figure 12 shows the host print transform process.

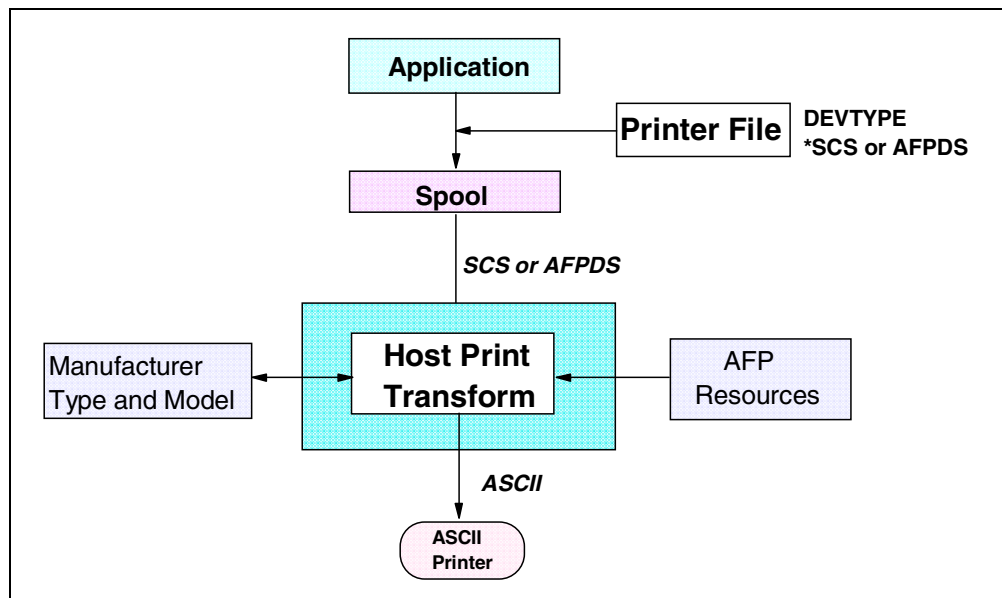

Figure 12. Host print transform process

ASCII printers support several different compositions of ASCII data streams. The host print transform function generates an ASCII printer data stream for a number

of IBM and non-IBM printers. To generate the different ASCII data streams, the host print transform function uses AS/400 system objects that describe characteristics of a particular printer. These objects are called *Work Station Customizing Objects* (WSCST), and it is possible to customize them.

For more information on host print transform, see Chapter 6, “Host print transform” on page 137.

1.3.4 Image print transform

Image print transform is an OS/400 function (Figure 13) included in Version 4.0 Release 2.0 that is capable of converting image or PostScript data streams into AFPDS and ASCII printer data streams. The conversion takes place on the AS/400 system, which means the data stream is independent of any printer emulators or hardware connections.

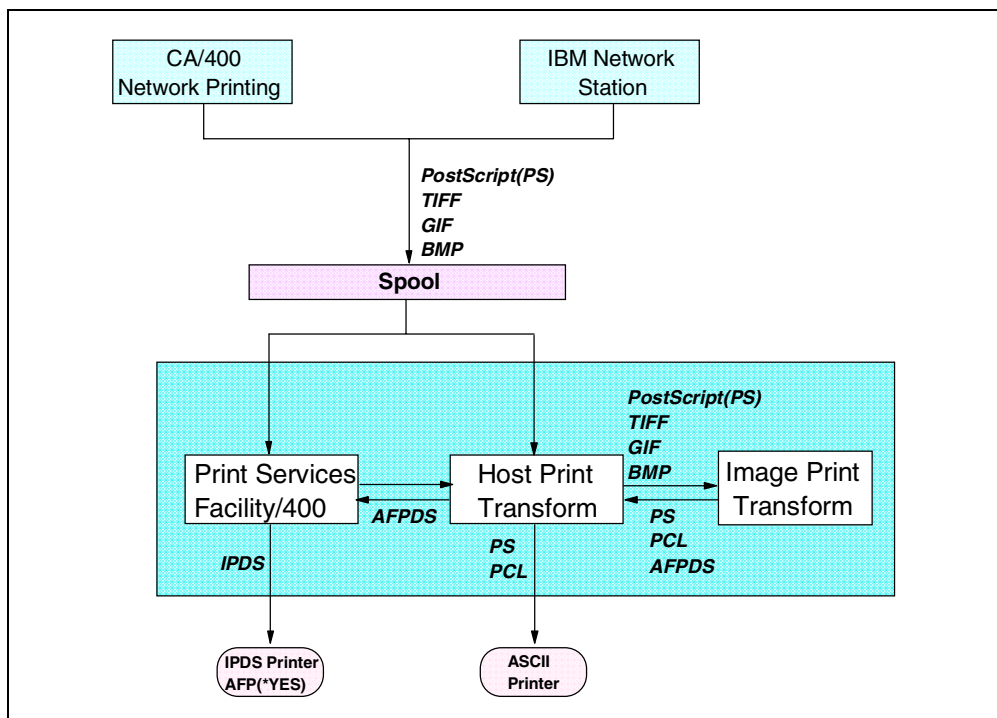

Figure 13. Image print transform function

Depending on the image configuration parameter in the printer device description and the spooled file data stream, Print Services Facility/400 or host print transform passes the spooled file to the image transform function.

The image print transform function converts image or print data from one format into another. The image print transform function can convert the following data streams:

- Tag Image File Format (TIFF)
- Graphics Interchange Format (GIF)
- OS/2 and Windows Bitmap (BMP)
- PostScript Level 1

The image print transform function can generate the following data streams:

- Advanced Function Print Data Stream (AFPDS)
- Hewlett-Packard Printer Control Language (PCL)
- PostScript Level 1

For detailed information on image print transform, see Chapter 7, “Image print transform” on page 161.

1.4 AS/400 printer attachment methods

This topic shows the different printer attachment methods on the AS/400 system depending on the type of printer, and gives information on the type of writer needed (print writer, PSF/400, or host print transform). The following attachment methods are discussed:

- Printers attached to a workstation controller or to an IBM 5x94 (Remote Control Unit)
- IPDS printers LAN attached
- ASCII printers attached to displays
- ASCII printers attached to PCs
- ASCII printers LAN attached
- Printers attached using PSF Direct
- Printers attached using PSF/2 DFP (Distributed Print Function)

Note: This topic only includes a discussion about printers directly attached and controlled by an AS/400 system, or in other words, printers for which there is a device description. All printers attached to remote systems or connected using a TCP/IP LPR/LPD attachment are discussed in 1.5, “Remote system printing” on page 22.

For information on printing SCS, IPDS, AFPDS, or USERASCII spooled files on the different attachment methods, see 1.6, “Printing SCS, IPDS, AFPDS, and USERASCII spooled files” on page 23. For information on IBM printers, see Appendix E, “Printer summary” on page 313.

1.4.1 Printers attached to AS/400 workstation controllers or IBM 5x94

Several IBM printers (line (SCS) or IPDS) can be attached directly to AS/400 workstation controllers by twinax cable. The same printers can also be attached by twinax to a Remote Control Unit IBM 5x94 (Figure 14 on page 16).

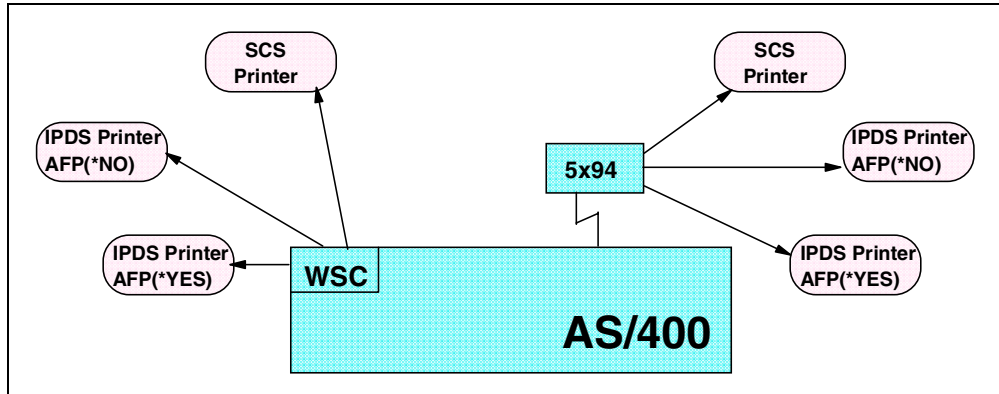

Figure 14. Printers attached to workstation controller or IBM 5x94

Note these considerations:

- Use the same functions if the printer is attached to a workstation controller or IBM 5x94.
- **Note:** IPDS printer are not fully supported on IBM 5294.
- If any IPDS printer is configured with the parameter AFP set to *YES, PSF/400 is required on the system.
- Some twinax attached IPDS printers must be configured AFP(*YES) (for example, an IBM 3130).

1.4.2 IPDS printers LAN-attached

Any IPDS printers with an IBM AFCCU (Advanced Function Common Control Unit) can be networked-attached to an AS/400 (for example, IBM Infoprint 60, Infoprint 70, Infoprint 62, Infoprint 2000, Infoprint 3000, and Infoprint 4000). These printers support one or more of the following attachments: SNA Token-Ring, SDLC, TCP/IP Token-Ring, and TCP/IP Ethernet.

IBM workgroup printers with the appropriate Network Interface Card (NIC) are supported. These printers include:

- IBM Network Printer 12 (4312)
- IBM Network Printer 17 (4317)
- IBM Infoprint 20 (4320)
- IBM Infoprint 21 (4321)
- IBM Network Printer 24 (4324)
- IBM Infoprint 32 (4332)
- IBM Infoprint 40 (4332)

For more information on IBM workgroup printers, see Chapter 10, “IBM AS/400 network printers” on page 205.

Using the I-DATA 7913 Printer LAN Attachment box (TCP/IP Token-Ring or Ethernet), it is also possible to attach the following IBM IPDS printers on the LAN: IBM 3812, 3816, 3912, 3916, 3112, 3116, 4028, 4230, and 6400.

The two-way dialog between the AS/400 system and the printer facilitated by IPDS enables the same general level of print functionality, print management,

and error recoverability for LAN/WAN-attached IPDS printers as is found in direct-attached (twinax) IPDS printers.

The capability of IPDS to “bridge” the network connection is especially important with TCP/IP attachment. Standard print support over TCP/IP (using LPR to LPD) is a one-way send of the spooled file, with limited support of print functions and no error recovery.

Note: For detailed information on IPDS LAN-attached printers configuration, see 11.1, “Configuring LAN-attached IPDS printers” on page 223.

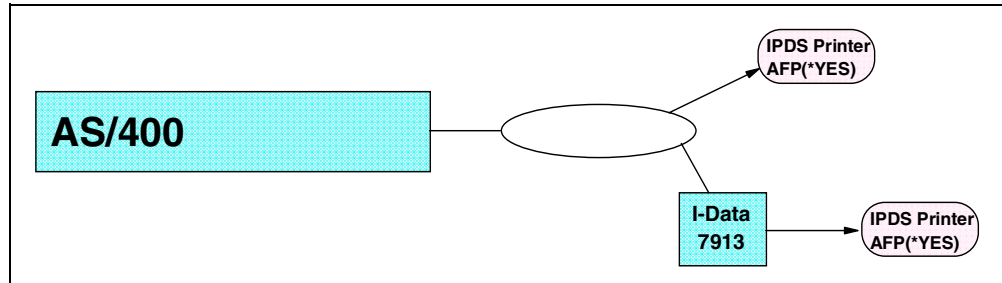

Figure 15. IPDS printers LAN-attached

Note these considerations:

- Any IPDS printer LAN attached to an AS/400 system (Figure 15) must be configured with the AFP parameter set to *YES; PSF/400 is required on the system.
- IPDS printers with an AFCCU and IBM network printers can be shared among different systems. The previous limit of three systems sharing an AFCCU TCP/IP-attached printer is removed by an enhancement provided by PTFs: on V3R2 (PTF SF42745), V3R7 (PTF SF42655), and V4R1 (PTF SF43250). This enhancement is part of the base code for V4R2.
- The IPDS printers IBM 4224 and 4234 are not supported.

1.4.3 ASCII printers attached to displays

The IBM InfoWindow displays 3477, 3486, 3487, 3488, and 3489 can be locally attached to the AS/400 system or remotely attached using an IBM 5x94 control unit through twinax cable. The InfoWindow displays have a printer port that can support the attachment of an ASCII printer (Figure 16 on page 18).

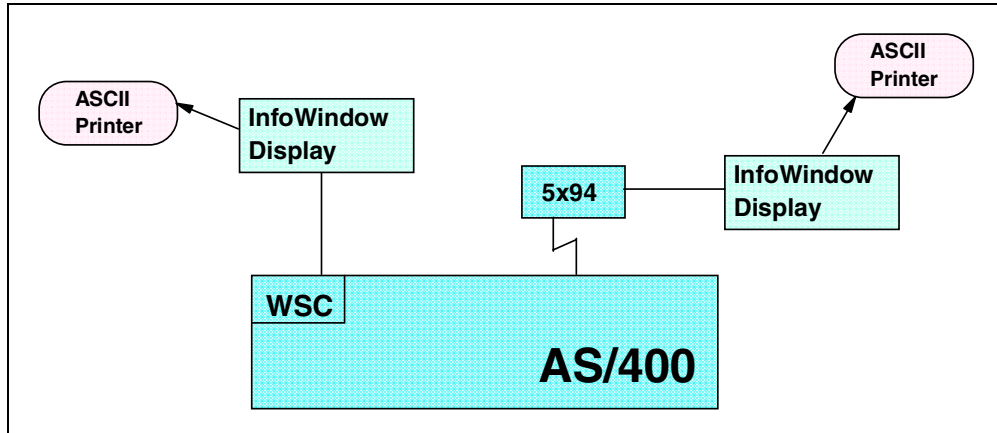

Figure 16. ASCII printers attached to displays

Note these considerations:

- Using display emulation, only SCS or USERASCII data streams are supported.
- Using host print transform, SCS, AFPDS, and USERASCII data streams are supported.
- USERASCII must be in the ASCII printer data stream of the target printer (for example, PCL5 or PPDS).
- If host print transform is used with AFPDS spooled files, the ASCII printer must support one of the following data streams: PCL4 or 5 (HP Laser and InkJet printers, IBM 4039, IBM Network Printers) or PPDS levels 3 and 4 (IBM 4019, 4029).
- PSF/400 is not required when printing AFPDS spooled files with host print transform.
- IPDS spooled files are not supported by 5250 emulation or host print transform.

1.4.4 ASCII printers attached to PCs

All ASCII printers can be connected to a PC using the standard parallel or serial port (Figure 17). PC5250 sessions are used to print AS/400 spooled files on the PC. When a spooled file is sent to a PC5250 printer session, it needs to be converted to an ASCII data stream supported by the target printer. There are three ways that this conversion occurs:

- PC5250 transform based on a Printer Definition Table (PDT)
- PC5250 transform based on the Windows 95/NT printer driver
- Host print transform

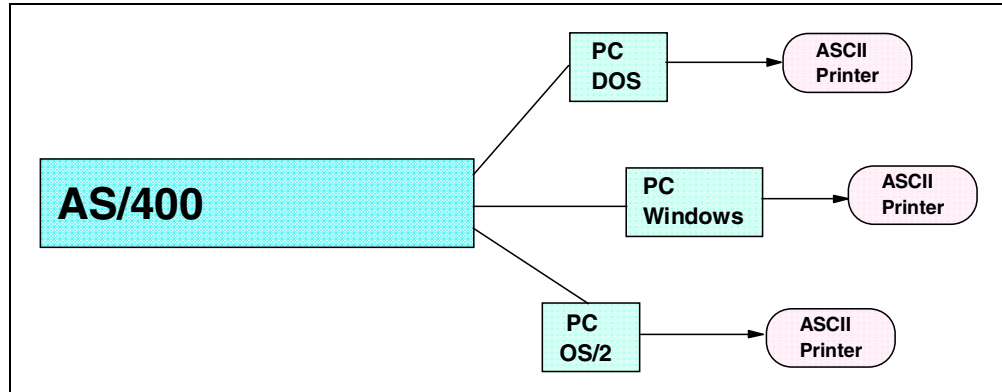

Figure 17. ASCII printers attached to personal computers

Consider these points:

- Using the PC5250 transform based on PDT, only SCS and USERASCII data streams are supported. PDT tables can be customized.
- Using the PC5250 transform based on the Windows 95/NT printer driver, only SCS and USERASCII data streams are supported. No customization is possible.
- Using host print transform, SCS, AFPDS, and USERASCII data streams are supported. Customization is possible.
- USERASCII must be in the ASCII printer data stream of the target printer (for example, PCL5 or PPDS).
- If host print transform is used with AFPDS spooled files, the ASCII printer must support one of the following data streams: PCL4 or 5 (HP LaserJet and InkJet printers, IBM 4039, IBM Network Printers) or PPDS levels 3 and 4 (IBM 4019, 4029).
- PSF/400 is not required when printing AFPDS spooled files with host print transform.
- IPDS spooled files are not supported by the PC5250 transform based on a PDT or on a Windows printer driver, and by host print transform.

For detailed information, see Chapter 9, “Client Access/400 printing” on page 185.

1.4.5 ASCII printers LAN-attached

ASCII printers may be attached on the network using Token-Ring or Ethernet connections (Figure 18 on page 20). For print writer support, there are three ASCII print drivers.

- Line Printer Requester (LPR). These are also known as remote output queue.
- PJI printer drivers. These drivers were released at OS/400 V3R7. The *IBMPJLDRV system driver supports HP printers.
- SNMP printer driver. This driver was released at V4R5. It is available for the IBM Infoprint 21 printer at V4R3 and V4R4 (via a PTF).

Note: The PJI and SNMP printer drivers are not available on CISC AS/400 systems (V3R2 and earlier).

For more information on the configuration of ASCII LAN-attached printers, see 11.2, “Configuring LAN-attached ASCII printers” on page 238.

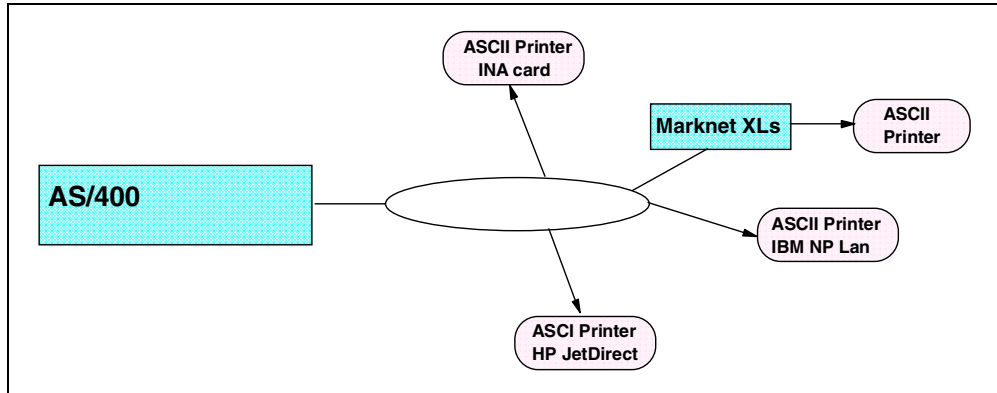

Figure 18. ASCII printers LAN-attached

Consider these points:

- As host print transform is used, SCS, AFPDS, and USERASCII data streams are supported.
- USERASCII must be in the ASCII printer data stream of the target printer (for example, PCL5 or PPDS).
- If host print transform is used with AFPDS spooled files, the ASCII printer must support one of the following data streams: PCL4 or 5 (HP LaserJet and InkJet printers, IBM 4039, IBM Network Printers) or PPDS levels 3 and 4 (IBM 4019, 4029).
- PSF/400 is not required when printing AFPDS spooled files with host print transform.
- IPDS spooled files are not supported by host print transform.
- If the new drivers are used, the printer must support Printer Job Language (PJL). PJL is not supported by all PCL ASCII printers (for example, not supported by IBM 4029 and HP III).
- ASCII printers LAN-attached can be shared between different systems (for example, an AS/400 system and a PC print server).
- Using a LAN-attached ASCII printer removes the limitations of an ASCII printer connected using a TCP/IP LPR-LPD connection (for example, default page format and page range to print).

Note: If your ASCII printer supports PJL and is actually connected with a remote output queue (TCP/IP LPR-LPD), we recommend that you connect it directly to the AS/400 system with the PJL drivers.

1.4.6 Printers attached to PSF Direct

PSF Direct support is provided by Print Services Facility/2 (PSF/2) and Print Services Facility/6000 (PSF/6000) (Figure 19). PSF Direct for OS/2 allows a maximum of 16 printers simultaneously. With PSF Direct attached printers, the control of the print remains on the AS/400 system, which means PSF Direct notifies the AS/400 system with any message (print completed, error messages, and so on).

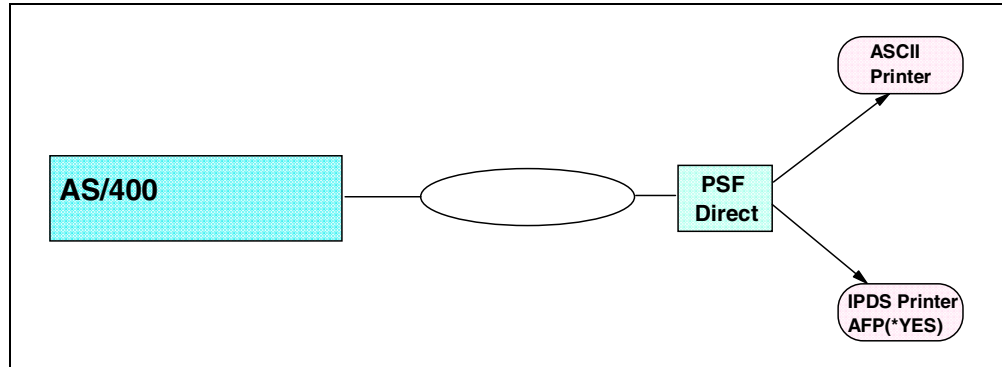

Figure 19. Printers attached to PSF Direct

Note these considerations:

- PSF/400 is required on the AS/400 system.
- PSF Direct allows the use of printer resident fonts.
- PSF Direct supports all the IBM IPDS laser printers, the IBM 4230, 6400 IPDS impact printers, and any PCL or PPDS compatible ASCII printers.

If the target printer is an ASCII printer, PSF Direct converts the IPDS data stream (received from PSF/400) into an ASCII data stream (in fact, it creates an image).

1.4.7 Printers attached to PSF/2 DPF

The PSF Distributed Print Function (DPF) is provided by Print Services Facility/2 (PSF/2). PSF/2 DPF allows up to 10 printers simultaneously. With PSF/2 DPF attached printers, print control is done by PSF/2 (Figure 20). The AS/400 system is not notified of any printer related messages (print completed, error messages, and so on).

PSF/400 transfers the spooled files to a queue on the PSF/2 system. When this transfer is done successfully, the PSF/2 returns an acknowledgment to the AS/400 system, and the spooled file is removed from the AS/400 output queue. Then PSF/2 takes control of the spooled file until it is printed.

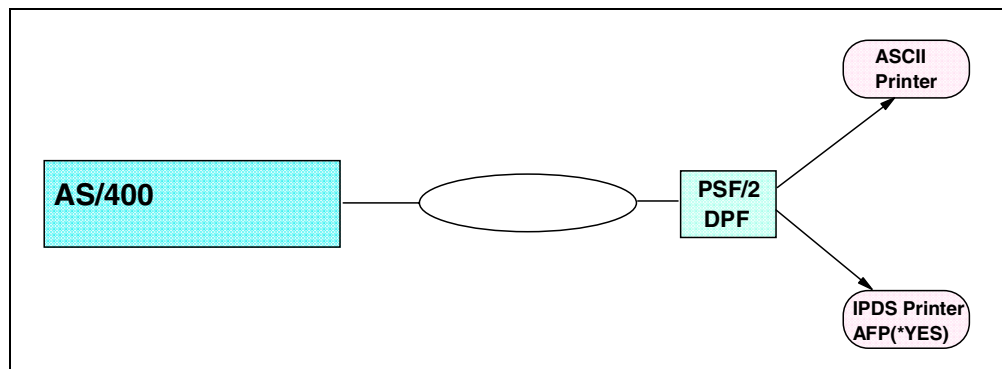

Figure 20. Printers attached to PSF/2 DPF

Note these considerations:

- PSF/400 is required on the AS/400 system.
- There is a time delay due to double spooling. PSF/2 does not start to print the spooled file until it has been completely received from the AS/400 system. This is particularly noticeable for large spooled files.
- PSF DPF does not use printer resident fonts, only fonts downloaded from the AS/400 system.
- PSF DPF supports all the IBM IPDS laser printers and any PCL or PPDS compatible ASCII printers.

If the target printer is an ASCII printer, PSF DPF converts the IPDS data stream (received from PSF/400) into an ASCII data stream (in fact, creates an image).

- IBM IPDS impact printers are not supported (for example, IBM 4230 and IBM 6400).

1.5 Remote system printing

Remote system printing (Figure 21) is particularly useful for customers who have networked systems for automatically routing spooled files to printers connected to other systems. Output queue parameters define the target system. Depending on the target system or printer, host print transform can be called to convert the spooled file into an ASCII printer data stream.

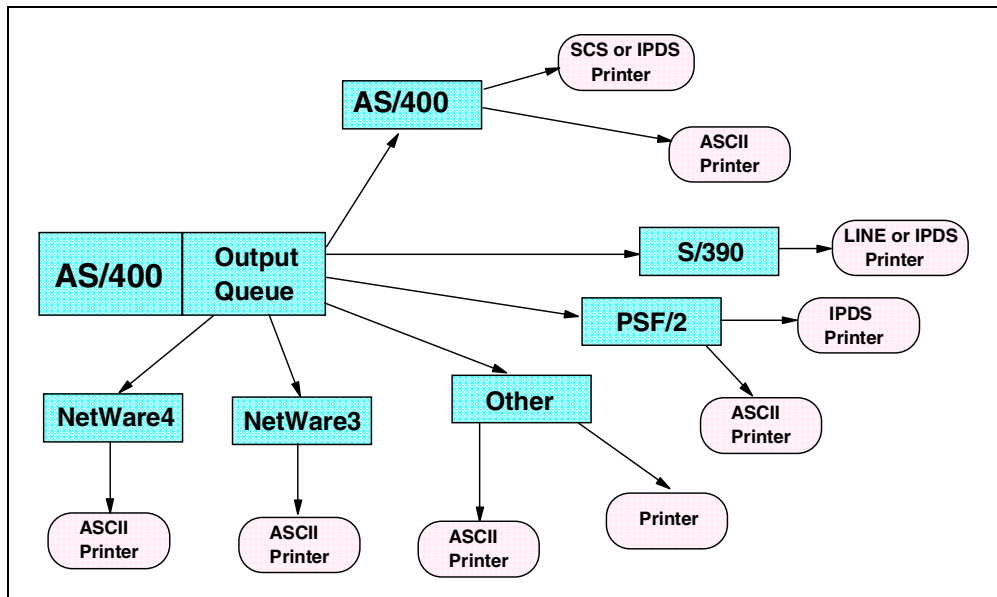

Figure 21. Remote system printing

Note these considerations:

- If the spooled file is *AFPDS, *LINE, or *AFPDSLIN, PSF/400 is only needed on the target system.
- Host print transform is only supported if the connection type parameter is set to *IP, *IPX, or *USRDFN.

- If host print transform is used, SCS, AFPDS, and USERASCII data streams are supported.
- USERASCII must be in the ASCII printer data stream of the target printer (for example, PCL5 or PPDS). TIFF, BMP, GIF, and PostScript level 1 are supported if using the image print transform function.

For more information on remote system printing, see Chapter 8, “Remote system printing” on page 171.

1.6 Printing SCS, IPDS, AFPDS, and USERASCII spooled files

This topic discusses printing SCS, IPDS, AFPDS, and USERASCII spooled files to printers attached to the AS/400 system or on the network by using remote system printing.

Note: For detailed information on the attachment methods, see 1.4, “AS/400 printer attachment methods” on page 15. For printing on the network, see 1.5, “Remote system printing” on page 22.

1.6.1 SCS spooled files

You can print SCS spooled files on:

- SCS or IPDS printers directly attached to a workstation controller, LAN, or IBM 5x94 (remote workstation controller):

If the target printer is an IPDS printer configured with AFP(*YES), PSF/400 is required on the system.

If the spooled file refers to an overlay (in the printer file), the target printer must be an IPDS printer configured with AFP(*YES). In this case, PSF/400 is required on the system.

If the target printer is SCS or IPDS AFP(*NO), the overlay parameter is ignored.

- ASCII printers by using an emulator or host print transform:

If the spooled file refers to an overlay, this parameter is ignored.

- PSF Direct attached printers:

PSF/400 is always required with PSF Direct attached printers.

- PSF/2 DPF printers:

PSF/400 is always required with PSF/2 DPF attached printers. Host resident fonts must also be available on the AS/400 system because PSF/2 DPF does not use printer resident fonts.

- Network with destination type OS400 or OS400V2:

If the spooled file refers to an overlay, this parameter is passed to the remote AS/400 system. In this case, PSF/400 is only needed on the remote system. The overlay must be available on the target system and found in the library list.

- Network with destination type S390:

The SCS spooled file is converted to a form of LINE data.

If the spooled file refers to an overlay, this parameter is not passed to the S/390.

- Network with destination type PSF2:

The SCS spooled file must be converted to ASCII since PSF/2 does not support SCS data stream. This can be done by specifying Host Print Transform(*YES) in the remote output queue definition.

If the spooled file refers to an overlay, this parameter is not passed to PSF/2.

- Network with destination type OTHER:

The SCS spooled file must be converted to ASCII since we mainly address an ASCII printer with a TCP/IP line printer daemon (LPD) attachment. This can be done by specifying Host Print Transform(*YES) in the remote output queue definition.

If the spooled file refers to an overlay, this parameter is not passed to the remote system.

1.6.2 IPDS spooled files

You can print AS/400-generated IPDS spooled files on:

- IPDS printers directly attached to a workstation controller, LAN, or IBM 5x94 (remote workstation controller):

If the target printer is an IPDS printer configured with AFP(*YES), PSF/400 is required on the system.

If the spooled file refers to an overlay (in the printer file), the target printer must be an IPDS printer configured with AFP(*YES). In this case, PSF/400 is required on the system.

If the target printer is IPDS AFP(*NO), the overlay parameter is ignored.

- PSF Direct attached printers:

PSF/400 is always required with PSF Direct attached printers.

- PSF/2 DPF attached printers:

PSF/400 is always required with PSF/2 DPF attached printers. Host resident fonts must also be available on the AS/400 system because PSF/2 DPF does not use printer resident fonts.

- Network with destination type OS400 or OS400V2:

If the spooled file refers to an overlay, this parameter is passed to the remote AS/400 system. In this case, PSF/400 is only needed on the remote system. The overlay must be available on the target system and found in the library list.

- Network with destination type S390:

The IPDS spooled file is converted to a form of LINE data only if no special device requirements are present (see the spooled file attributes). If special device requirements are present (normally they are with an IPDS spooled file), the spooled file cannot be transferred to the S/390.

If the spooled file refers to an overlay, this parameter is not passed to the S/390.

The following types of printing are *not* supported:

- Printing on a ASCII printers using an emulator or host print transform
- Printing on a network with destination type PSF2
- Printing on a network with destination type OTHER

1.6.3 AFPDS spooled files

You can print AFPDS spooled files on:

- IPDS AFP(YES) printers directly attached to a workstation controller, LAN, or IBM 5x94 (remote workstation controller):
PSF/400 is required on the system.
- ASCII printers by using host print transform:
PSF/400 is not required on the system.
- PSF Direct attached printers:
PSF/400 is always required with PSF Direct attached printers.
- PSF/2 DPF attached printers:
PSF/400 is always required with PSF/2 DPF attached printers. Host residents fonts must also be available on the AS/400 system because PSF/2 DPF does not use printer resident fonts.
- Network with destination type OS400 or OS400V2:
If the spooled file refers to AFP resources, this information is passed to the remote AS/400 system. In this case, PSF/400 is only needed on the remote system. The AFP resources must be available on the target system and found in the library list.
- Network with destination type S390:
If the spooled file refers to AFP resources, this information is passed to the remote System/390. The AFP resources must be available on the target system.
- Network with destination type PSF2:
If the spooled file refers to AFP resources, this information is passed to the remote PSF/2 system. The AFP resources must be available on the target system.
- Network with destination type OTHER:
The AFPDS spooled file must be converted to ASCII since we mainly address an ASCII printer with a TCP/IP line printer daemon (LPD) attachment. This can be done by specifying Host Print Transform(*YES) in the remote output queue definition. The ASCII printer must support one of the following data streams: PCL4/5 or PPDS levels 3 or 4.

Printing on ASCII printers using an emulator is not supported.

1.6.4 USERASCII spooled files

Spooled files with a device type *USERASCII can contain any type of ASCII printer data stream (for example, PCL5, PPDS, or PostScript). The writer program just passes the spooled file to the target printer. The spooled file is not checked for validity.

Note: The following considerations do not address using the image print transform function (V4R2) on the AS/400 system. For printing USERASCII spooled files with the image print transform function (V4R2), see 1.6.4, “USERASCII spooled files” on page 25.

You can print *USERASCII spooled files on:

- ASCII printers using an emulator or host print transform
- A network with destination OS400 or OS400V2
- A network with destination PSF2
- A network with destination OTHER

The following types of a printing are not supported:

- Printing on SCS or IPDS printers attached to a workstation controller, LAN, or IBM 5x94 (remote workstation controller)
- Printing on PSF Direct attached printers
- Printing on PSF DPF attached printers

1.6.5 USERASCII spooled files with image print transform

The image print transform function allows you to print USERASCII spooled files in the TIFF, GIF, BMP, or PostScript Level 1 format on IPDS AFP(*YES) printers or ASCII printers. For an overview of image print transform, see 1.3.4, “Image print transform” on page 14. For detailed information, see Chapter 7, “Image print transform” on page 161.

You can print *USERASCII in TIFF, GIF, BMP, or PostScript Level 1 spooled files on:

- IPDS AFP(*YES) printers attached to a workstation controller, LAN, or IBM 5x94 (remote workstation controller):
PSF/400 is required on the system.
- ASCII printers using host print transform.
- Printing on PSF Direct attached printers:
PSF/400 is always required with PSF Direct attached printers.
- Printing on PSF DPF attached printers:
PSF/400 is always required with PSF DPF attached printers.
- A network with destination OS400 or OS400V2
- A network with destination PSF2
- A network with destination OTHER

These types of printing are not supported:

- Printing on SCS or IPDS AFP(*NO) printers attached to a workstation controller, LAN, or IBM 5x94 (remote workstation controller)
- ASCII printers using an emulator
- Printing on a network with destination S390

1.7 Implementing a printing concept

When designing any printing solution, you must have the correct printer types to fit the printing requirements. Consider the following list in order of priority:

1. Print criticality
2. Print output requirements
3. Printer file device type
4. Writer supporting spooled files data streams
5. Printer requirements
6. Type of printers
7. Printer attachment methods

Note: We refer to each of these points as steps in the following sections.

This section also discusses using PSF/400 and IPDS printers versus host print transform and ASCII printers, and how to enhance your output presentation.

1.7.1 Print criticality

The importance of a given print application to the organization, or print criticality, influences the design of the printing solution, at least for that application. Print criticality can be a measure of the importance of the document or the print volumes, or a combination of the two. A low volume application, such as check printing, may be critical because of the precise need to control the print process. With most production applications—volumes over 60 impressions per minute, the individual documents may be less critical, but the performance and stability of the entire process is key. The higher the critical nature is of the print application, the more important the fundamentals are of the printing process. These include:

- Precise control over the printing process
- Assurance that what is directed to be printed *is* printed, with adequate print management to respond and resolve error situations
- Control over performance factors

1.7.2 Print output requirements

The print output requirements include which type of documents have to be printed and their contents. Documents can be simple lists. Some documents may require barcodes, overlays, logos (images), or different fonts. Also consider documents that are received from Client Access/400 or other systems.

Examples of typical spooled files in an AS/400 environment are:

- Simple lists
- Documents including different fonts (for example, a Courier and an OCR font)
- Documents with barcodes
- Documents with overlays and page segments (logos, images)
- OfficeVision/400 documents
- PC documents (Lotus AmiPro or Freelance, MS Word)

1.7.3 Printer file device type

According to the print output requirements that you define (step 2), the Printer file device type parameter (DEVTYPE) can be determined. The device type parameter is used to create the spooled file in the desired data stream. For more

information on data streams, see 1.2, “Data streams supported on the AS/400 system” on page 3.

Considering the example of the typical spooled files in an AS/400 environment (step 2), the device type parameter can be:

- SCS for simple lists:
Simple lists are normally printed using one font (often the default font from the printer file or printer device).
- IPDS or AFPDS for documents including different fonts (for example, Courier and an OCR font):
Referencing a font can be done by using the FONT DDS (data description specification) keyword if the device type parameter is IPDS or AFPDS (not supported if SCS), or by using the FNTCHRSET (Font Character Set) DDS keyword. This keyword is only supported if the device type is AFPDS.
- IPDS or AFPDS for documents with barcodes:
Barcodes are created by using the BARCODE DDS keyword. This keyword is only supported if the device type is IPDS or AFPDS.
- SCS, IPDS, or AFPDS for documents with overlays and page segments (logos, images):
An overlay, which either includes page segments or does not include them, can be referenced in the printer file (FRONTOVL and BACKOVL parameters) if the data type is SCS, IPDS, or AFPDS.
The DDS keywords OVERLAY and PAGSEG can only be used if the device type is AFPDS.
- SCS for OfficeVision/400 documents:
The device type for OfficeVision documents is always SCS. An overlay can be associated with an OfficeVision/400 document. It must be referenced in the printer file (FRONTOVL and BACKOVL parameters).
- AFPDS or USERASCII for PC documents (Lotus AmiPro or Freelance, Microsoft Word):
Using the network printing function from Client Access/400, PC application outputs can be directed to an AS/400 output queue. The target printer determines the data stream to use. Output from PC applications is supported in USERASCII (ASCII data stream determined by the printer driver used) or in AFPDS (in this case, the AFP driver is used).

1.7.4 Writer supporting printer file device type

The print writer used to pass the spooled file to the printer can be one of the following types:

- Print writer
- Print Services Facility/400 (PSF/400)
- Host print transform

As you can see in Figure 22, each of these options supports different data streams and can make various data stream conversions.

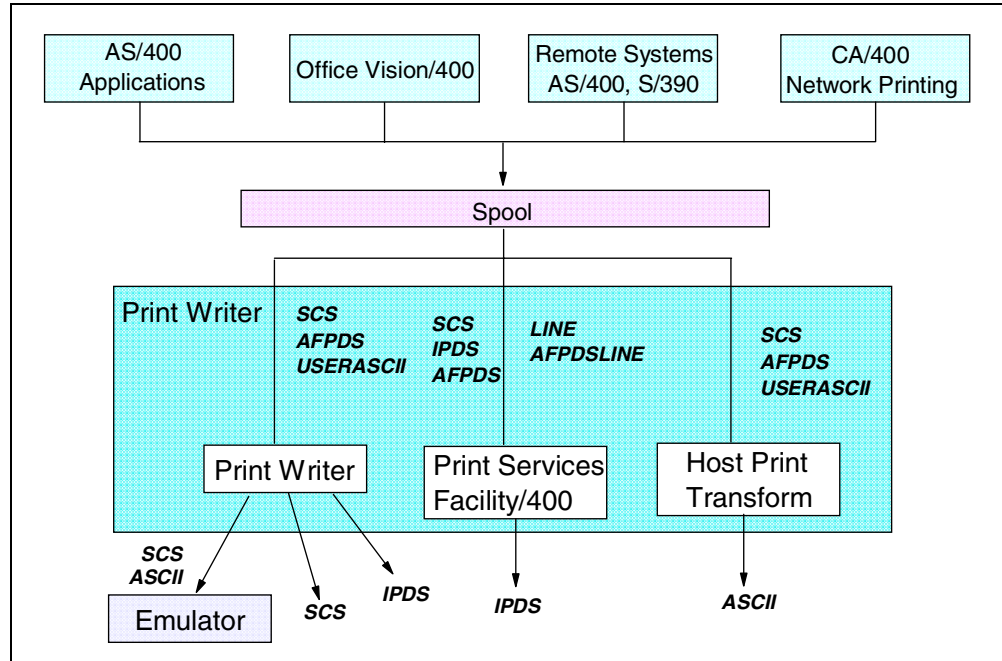

Figure 22. AS/400 print writer and data streams

For detailed information on the printer writer, see 1.3, “Printer writer” on page 6.

Depending on the print output requirements that you define (step 2) and the device type required for the different spooled files (step 3), you can determine the type of writer to use. Consider the following facts:

- SCS is supported by all three options.
- IPDS is supported by the print writer and PSF/400.
- AFPDS is supported by PSF/400 and host print transform.
- Since overlay and page segments are part of the requirements, only PSF/400 and host print transform can support them.

PSF/400 supports an overlay referenced in the printer file with an SCS, IPDS, or AFPDS spooled file, and overlays and page segments referenced with the DDS keywords OVL and PAGSEG when the spooled file is AFPDS.

Host print transform supports an overlay referenced in the printer file only when the spooled file is AFPDS, and overlays and page segments referenced with the DDS keywords OVL and PAGSEG when the spooled file is AFPDS.

Note: Overlays referenced in the printer file with a spooled file in SCS are not supported by host print transform.

- PC documents (Lotus AmiPro or Freelance, Microsoft Word) in AFPDS can be supported by PSF/400 or host print transform. If the documents are in USERASCII, they can only be supported by host print transform or the print writer and an emulator.

From this analysis, you can conclude that Print Services Facility/400 can be used for all of the document type parts of the requirements, but that host print transform can also be used with the exception of any overlay referenced in a printer file with an SCS spooled file.

1.7.5 Printer requirements

The printer requirements help in selecting the correct printer types. The following information must be available:

- Centralized, departmental, or end-user printing
- Print volume
- Type of forms (continuous, page)
- Laser printer or impact printer (or both)
- Print on other systems (remote system printing)

For many AS/400 system environments, you can consider:

- Centralized printing for some applications, high volume, and large spooled files.
- End-user printing, low volume, some output from the same application producing large spooled files. For some end users, this mainly includes documents from PC applications.
- Type of form is page, same format and paper desired for all the printers.
- Laser printer, presentation quality requested.
- One department uses PC applications (Office) intensively.

From this information, you can conclude that you must have a laser printer for high volume and large spooled files (and eventually a backup printer) and laser printers for the end users. A PC print server can also be considered for one department.

1.7.6 Types of printers

For step 4, writer supporting spooled files data streams, the conclusion is that Print Services Facility/400 can support all the print requirements and host print transform can support most of them.

For step 5, printer requirements, the conclusion is that a laser printer for large volume, laser printers for end users, and a PC print server can be considered.

Figure 23 shows the printer types supported according to the writer option.

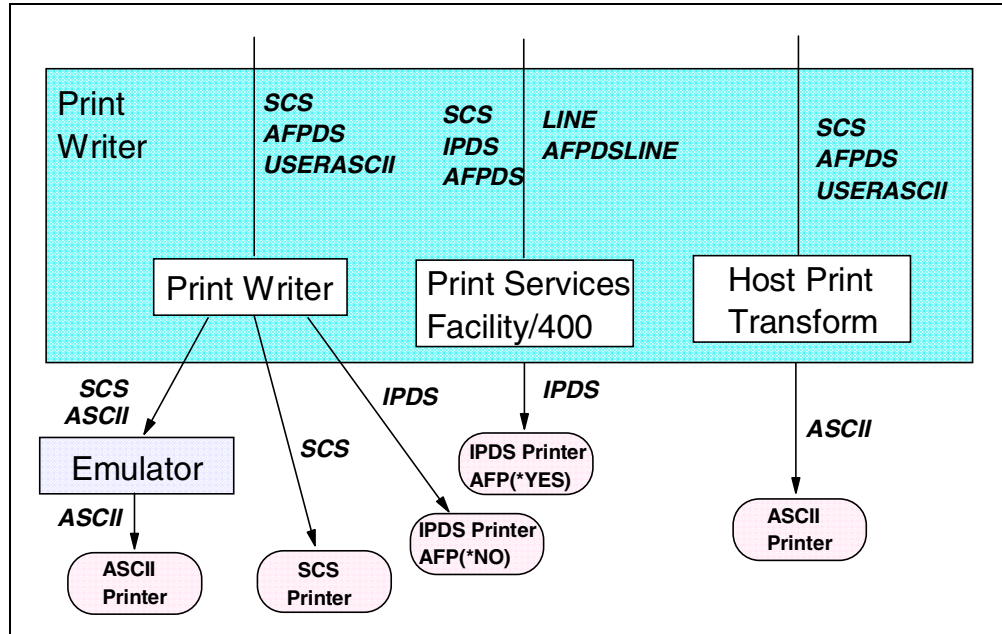

Figure 23. AS/400 print writer and printer types

PSF/400 can support production IPDS printers with speeds from 110 to 1002 impressions per minute (Infoprint 2000, Infoprint 3000, and Infoprint 4000). Lower volume centralized or departmental print can be handled by Infoprint 70 (cut sheet), Infoprint 62 (continuous forms), and Infoprint 60 (cut sheet).

For end-user printing, PSF/400 or host print transform can be used as both support the AFPDS data stream. As one department uses PC applications intensively and to avoid too many conversions, these spooled files can be passed as USERASCII to the AS/400 system or directed to a PC print server.

A good choice for network deployment is shared network printers, such as Infoprint 20, Infoprint 21, Infoprint 32, and Infoprint 40. These printers support multiple concurrent print writer sessions across AS/400 and other network clients or servers. They can be defined to the AS/400 system as both IPDS printers or ASCII (PCL) printers. Two device descriptions, one AFP and one ASCII, can be created for the same printer on the AS/400 system.

Note: In V3R2, a remote output queue must be used if the printer is LAN attached because the PJI driver is not available.

If a PC print server is used, this print server can be connected to an IBM Network Printer (used as an ASCII printer). The PC print server and the AS/400 system share the printer.

If host print transform is used for the end-user printer, any ASCII laser printer can be used. The same printer can also be used with the PC print server.

For considerations on PSF/400 and IPDS printers versus host print transform and ASCII printers, see 1.7.8.1, “PSF/400 IPDS printers versus HPT ASCII printers” on page 32.

1.7.7 Printer attachment methods

On the AS/400 system, there are many different ways in which printers can be attached. For detailed information, see 1.4, “AS/400 printer attachment methods” on page 15. The LAN connection allows printer sharing for both IPDS and ASCII printers (both IPDS and ASCII printers can be LAN-attached).

1.7.8 What must be considered

When deciding what printing solution to implement, consider:

- PSF/400 and IPDS printers versus host print transform (HPT) and ASCII printers
- How to enhance your output presentation

1.7.8.1 PSF/400 IPDS printers versus HPT ASCII printers

Host print transform cannot be considered for high print volume and higher print speeds. Depending on the print criticality (see 1.7.1, “Print criticality” on page 27), using PSF/400 and IPDS printers is the recommended choice.

In the discussion about Print Services Facility/400 and IPDS printers versus host print transform and ASCII printers for low print volume (end-user printing), consider the following points:

- **Performance:**

Performance considerations are magnified at higher print speeds. Where use of ASCII printers with host print transform may be acceptable at entry print speeds (6 to 20 impressions per minute), the transform workload and data stream inefficiencies will have a significant impact at higher print speeds. IBM IPDS printers currently extend to 1002 impressions per minute (IBM Infoprint 4000).

Host print transform (HPT) uses more AS/400 resources, specifically when working with the AFPDS-to-ASCII transform. This is due to the AFP resources handling and remapping.

When using AFP resources, PSF/400 uses resource retention on the printer. With this function, the AFP resources, overlays, page segments, and fonts remain on the printer from job to job and are only deleted when the writer is ended.

Note: In V4R2, some IPDS printers can keep downloaded fonts even if the writer is ended and the printer is powered off.

Host print transform clears the downloaded AFP resources at the end of each print job (that is, when you print three spooled files referencing the same overlay, the overlay is downloaded three times). This can be costly for communication lines and can cause poor performance.

- **Recoverability:**

PSF/400 has a two-way dialog with the IPDS printer. The printer can report positive acknowledgement or negative acknowledgment to PSF/400. When a spooled file is printed on an IPDS printer, the spooled file remains in the AS/400 output queue until the printer has finished printing it, and the last page is safely in the output bin. At this time, the printer sends a positive acknowledgement to PSF/400, and the spooled file is deleted from the output

queue. Even if the printer is powered off (normal recovery procedure for some end users...), the spooled file remains available on the AS/400 system.

ASCII printers do not have any dialog with the AS/400 system, which means they cannot report back any information. When the transfer of the spooled file to the ASCII printer is done, the spooled file is deleted from the output queue. If for any reason the ASCII printer is powered off, the spooled file (or more than one) is (or are) lost.

To circumvent this risk, the SAVE parameter can be set to “*YES” in the printer file. With this circumvention, extra work is necessary to clean up the output queue.

- **Fidelity:**

PSF/400 does not need special customization. The IPDS printer characteristics (paper loaded, resident fonts and codes pages, drawers and bins information, available IPDS towers, resolution, and so on) are passed from the printer to PSF/400 every time a print writer starts. With this information, PSF/400 can build the IPDS data stream according to the printer specifications. Thus, PSF/400 supports all printer file parameters.

PSF/400 allows you to control what is done if it encounters certain formatting difficulties. With the FIDELITY(*CONTENT), PSF/400 tries to print as much as it can and sends a message to the operator if there are any problems. With FIDELITY(*ABSOLUTE), the writer holds the spooled file and does not print it if PSF/400 is unable to print it exactly as requested.

Host print transform uses a manufacturer type and model table to convert SCS or AFPDS to ASCII. These tables are available on the OS/400 for many ASCII printers. Accordingly (for example, the fonts, drawers, and print positions used in the application, or to handle the unprintable border present on almost all ASCII printers), a customization of the transform table may be required. Customizing an ASCII printer may involve a trial-and-error process. For more information on customizing HPT tables, see 6.7, “Host print transform customization” on page 151.

- **Currency:**

Support and testing for IBM AS/400 printers is built into each OS/400 and PSF/400 release. This support includes new printer features and generally works with the printer as a native printer device, not as a printer emulating an older printer. Support is implemented in standard AS/400 interfaces such as printer files and DDS.

ASCII printers supported by host print transform do not go through this development and integration process, resulting in certain functions or features being unsupported. Customization of the transform table may address this, but only if it is a function already supported by SCS and AFP print support.

1.7.8.2 Enhancing your output presentation

Central to the implementation of a new print solution are changes in the presentation output. There are many different approaches to enhancing an application's printed output, including:

- Any application producing SCS output can be enhanced without application changes by:
 - Adding an overlay (for example, by specifying an overlay name in the FRONTOVL parameter of the printer file). For more information, see Chapter 2, “Advanced Function Presentation” on page 35.
 - Changing the complete document presentation (field positions, fonts, barcoding, copies, and so on) by using Advanced Print Utility (APU), part of PrintSuite for AS/400. For more information, see Chapter 3, “Enhancing your output” on page 67.
 - Changing the complete document presentation by using page and form definitions. For more information, see Chapter 3, “Enhancing your output” on page 67.
- Any application currently producing SCS or IPDS output can be changed to AFPDS and can take advantage of the AFPDS DDS keywords. AFPDS DDS keywords, such as OVERLAY, PAGSEG, FNTCHRSET, BOX, and LINE, are part of the AS/400 printer file. Since using the printer file DDS is integrated with the application program, changes may be required to the application program. For more information, see Chapter 2, “Advanced Function Presentation” on page 35.

Chapter 2. Advanced Function Presentation

The Advanced Function Presentation (AFP) architecture has been supported on the AS/400 system since Version 2.0 Release 1.0. Significant new capabilities have been added with each new release, resulting in a comprehensive document and printing system.

The architecture was formerly known as *Advanced Function Printing*, but its capabilities now include viewing, faxing, and archival/retrieval solutions (therefore, the change of name; AFP manages the *presentation* of information).

This chapter provides an overview of AFP implementation on the AS/400 system and describes several different models used to produce AFP printing solutions.

2.1 Overview of AFP on the AS/400 system

It is important to define some terms before we describe the AS/400 AFP model. We start by explaining what AFP is.

2.1.1 What AFP is

Advanced Function Presentation is an architecture using a wide range of functions to provide capabilities such as print formatting, viewing, and archiving. Three components in the AFP architecture are:

- AFP data stream (AFPDS)
- AFP resources (overlay, page segment, fonts, formatting definitions)
- Print management (Print Services Facility (PSF))

The AFP architecture may also be referred to as MO:DCA-P (Mixed Object Document Content Architecture for Presentation).

Several data streams are supported in the AFP architecture:

- AFPDS
- LINE
- AFPDSLIN (mixed data)

Intelligent Printer Data Stream (IPDS) is not strictly part of the AFP architecture, but is closely associated with it. IPDS is the formatted, printer-specific data stream actually sent to the print device.

2.1.2 AS/400 AFP model

Basically, whatever you print on the AS/400 system uses a printer file. Printer files determine how the system handles output from application programs. Printer files fit into one of two groups:

- **Program-described printer files:**

These printer files do not have any field or record-level formatting. The attributes of the printer file are used to define how *all* the data in the spooled file is printed. Any positioning of information within the file has to be determined by the application program. Most of the printer files delivered with OS/400 and many vendor application packages use these simple printer files.

An example is QPDSPLIB—the OS/400-supplied printer file used to define how pages of a library printout will appear. Although the font, print orientation, and other attributes may be modified by changing the printer file, the appearance of individual pages cannot be modified.

- **Externally-described printer files:**

These printer files have formatting defined using Data Description Specifications (DDS) external to the application program. Some of the attributes of the printer file apply to the entire data as before, while the DDS can override or enhance these options for individual records or fields (for example, a single field can be printed as a barcode).

All the document elements of AFP (for example, overlays, page segments, fonts, barcodes, lines, and boxes) are supported by DDS keywords. Using these keywords to lay out pages is the standard, integrated method of defining application output on the AS/400 system. With Version 3.0, each of these keywords has been made dynamic. This means that both characteristics (for example, overlay name) and page placement (position) can be passed dynamically (as a program variable) from the application program. This enables pages of output to be precisely customized based on application data.

Figure 24 shows how the printer file fits into the AFP printing process. Each step in the process is explained in the notes following the figure.

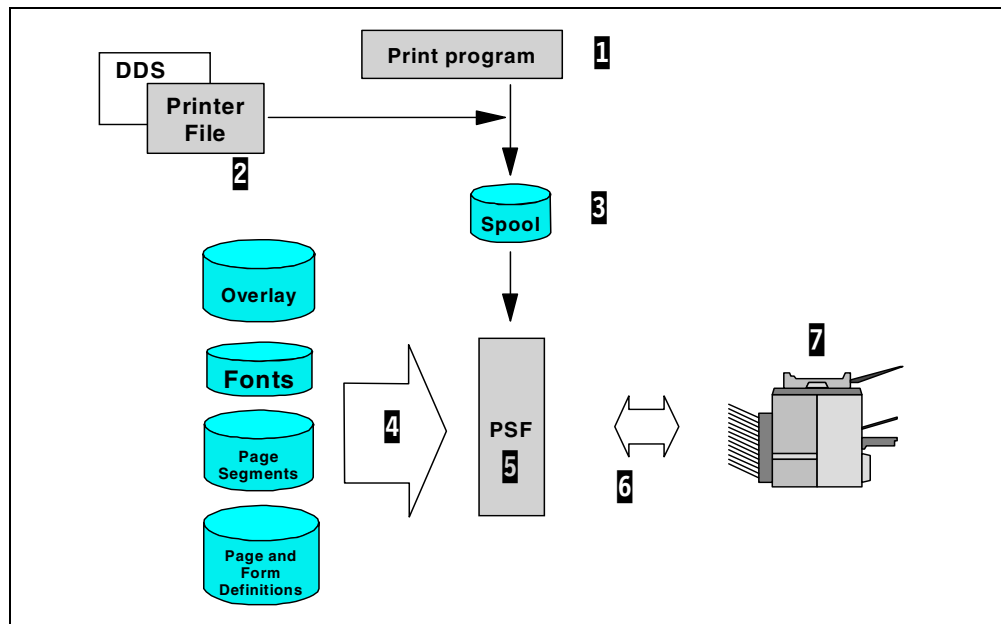

Figure 24. Printer file model

Notes

- 1** The application program is invoked by the user to print data from the AS/400 system and to produce a spooled file.
- 2** The printer file parameters are used to format the data. Data Description Specifications (DDS) are optionally used to improve the appearance of the data.
- 3** The spooled file contains the data from the program with the appropriate formatting instructions as defined in the printer file. External resources, such as fonts or overlays, are not embedded in the spooled file. Only references to them are embedded.
- 4** The AFP resources are added to the print process at print time by PSF/400.
- 5** PSF/400 sends the print data and the resources to the printer.
- 6** PSF/400 manages all the printer tasks such as printer characteristics, resources management, and error recovery.
- 7** IPDS printers communicate with the system to provide information about the printer and the status of the print job.

Now that you understand the basic AFP print process on the AS/400 system, let's look at how certain AFP application enablers are used on the system.

2.1.3 APU print model

Advanced Print Utility (APU) provides the capability to modify the appearance of an SCS spooled file without any application modifications. APU can be used when access or skills to modify application source code is not available. In addition, APU can be used when it is desirable to separate complex page formatting from the application program.

The user can manipulate the data appearance on any AS/400 workstation or PC 5250 session. The collection of the data modification is saved in a new object (the APU Print Definition) containing the new formatting information. The print definition is used by the APU print engine to create a new spooled file. The print definition may be applied interactively, or as part of a Control Language (CL) program. It may also be applied automatically using the APU monitor function supplied with APU. This is described in the notes following Figure 25 on page 38.

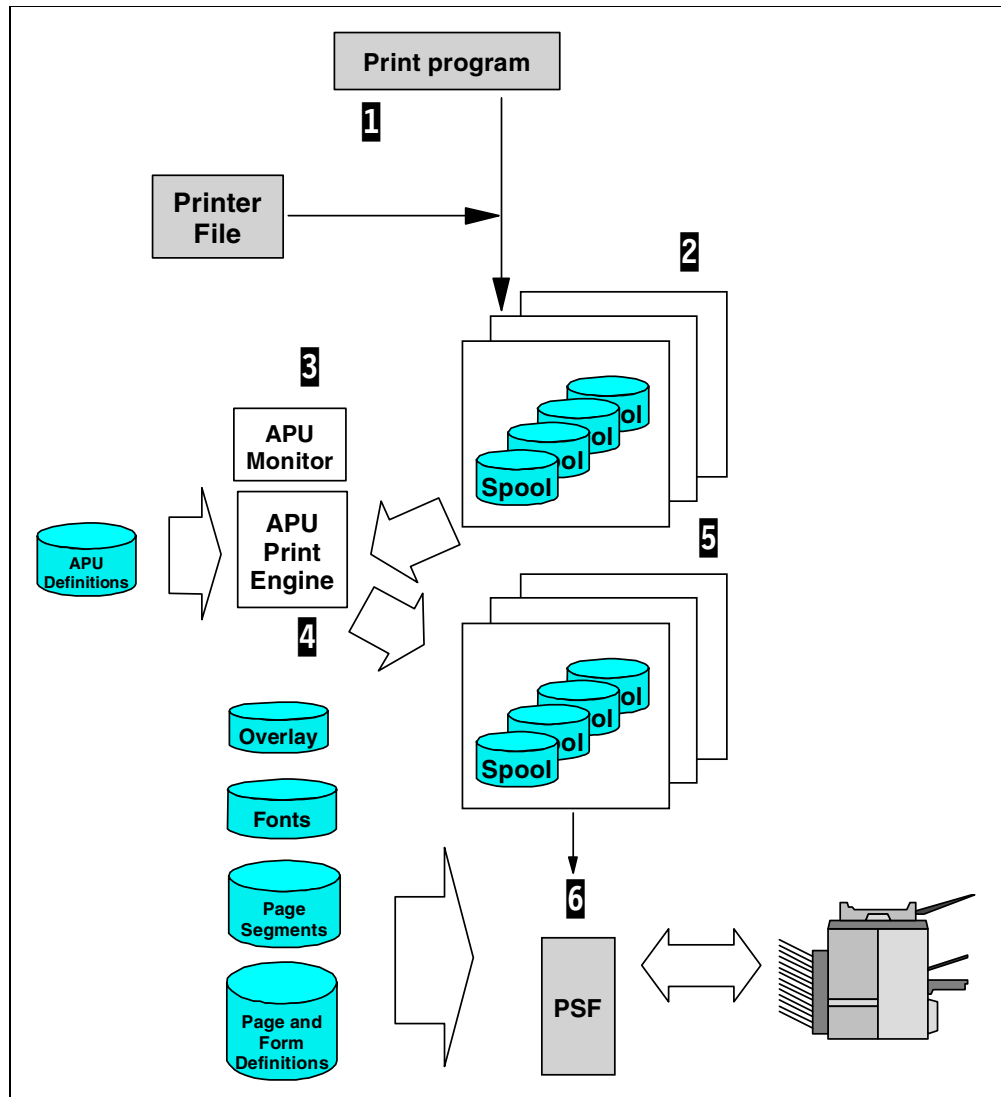

Figure 25. APU print model

Notes

- 1 The application program produces an SCS spooled file on the output queue.
- 2 Any output queue may be used. However, the monitor cannot capture the spooled file if a print writer is attached to this output queue.
- 3 The users have to define which output queues are monitored. The monitor supervises all entries in the monitored output queues and invokes the APU print engine as soon as the spooled file entries match the print definition requirement.
- 4 At this time, the information contained in the APU print definition is used by the print engine to write a new AFP spooled file.
- 5 The new spooled files are placed in an output queue according to the monitor definition. This process is explained in more detail in 2.4.4, “Advanced Print Utility (APU) monitor enhancement” on page 52.
- 6 The AFP resources are added to the print process at print time by PSF/400. It then sends the print data and the resources to the printer.

Advanced Print Utility (APU) is one of the components of PrintSuite/400 with the following licensed program numbers:

- 5798-AF2 for OS/400 V3R2
- 5798-AF3 for OS/400 V3R7 through V4R5

The PrintSuite/400 components can be ordered independently of each other.

Note: APU and PrintSuite/400 are not available for OS/400 V3R1 or V3R6.

2.1.4 PFU print model

Print Format Utility (PFU) (Figure 26 on page 40) is a part of AFP Utilities/400 (AFP Utilities/400). PFU allows customers to print database file data as an AFP formatted report without any programming. A popular use of PFU is to easily define a multi-up label application using various graphical elements, barcodes, and a variety of fonts.

Where overlays and page segments are AS/400 objects used for AFP printing, Print Format Definitions (PFDs) are members of specialized database files created with AFP Utilities/400. With PFDs, you can define record layouts containing variable data from a database file and page layouts containing fixed data (text, boxes, lines, barcodes, graphics, and page segments). The AFP Utilities/400 licensed program is required on each system used to define or print with PFDs.

PFU is a part of the AFP Utilities/400 and cannot be ordered separately. AFP Utilities/400 has the order number 5769-AF1 for OS/400 V4.

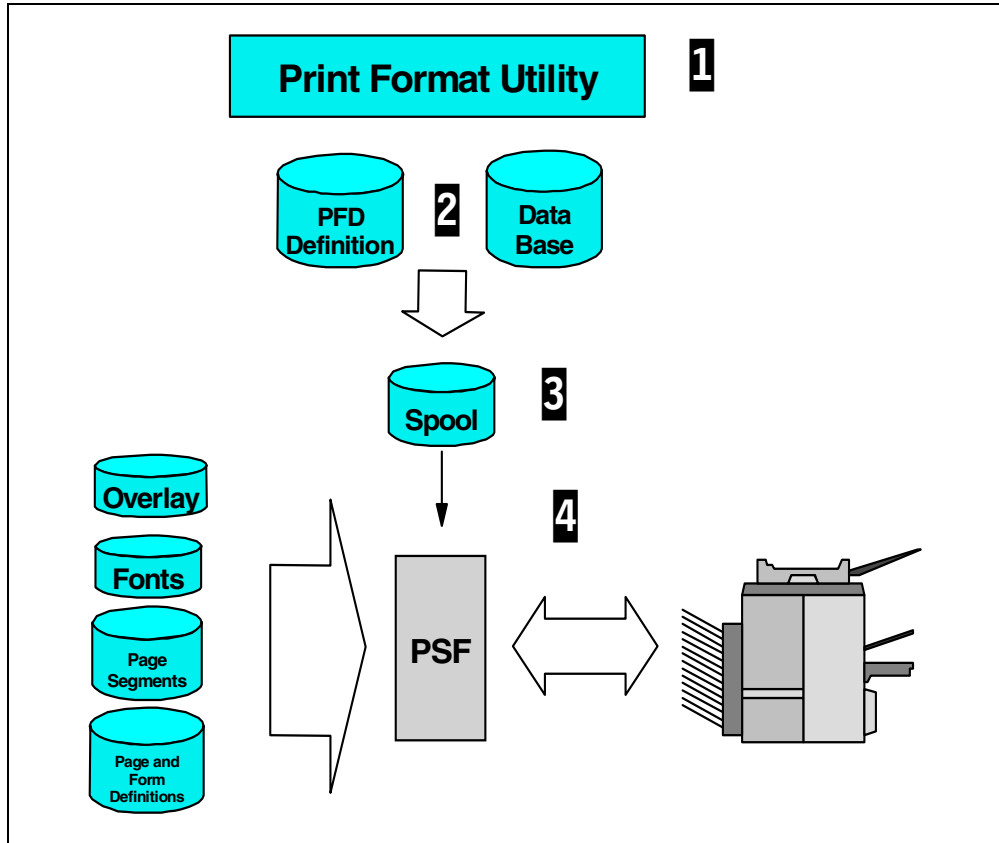

Figure 26. Print Format Utility print model

Notes

- 1** After the PFD definition is created, you can invoke the print process manually in PFU or use the Print PFD Data (PRTPFDDTA) command, which is part of AFP Utilities/400.
- 2** PFU extracts the database data using the PFD definition and provides an AFPDS spooled file.
- 3** After the AFPDS spooled file is placed in the output queue, the regular print process applies.
- 4** The AFP resources are added to the print process at print time by PSF/400. It then sends the print data and the resources to the printer.

2.1.5 Page and form definitions print model

Page and form definitions are standard AFP resources that separate page formatting from application program logic. Page and form definitions are developed in a source programming language that determines how the existing fields and lines of application output will be changed and composed into full AFP pages. With Version 3.0 Release 2.0 and Version 3.7 Release 7.0 and later, page and form definitions can be specified directly in the printer file.

A new compiler, Page Printer Formatting Aid (PPFA)—one of the four AFP PrintSuite products, is available to compile page and form definition source modules into AS/400 objects. Page and form definition object modules can also be transferred from other systems or be created with PC design tools.

Figure 27 illustrates how page and form definitions change the standard AS/400 printing process.

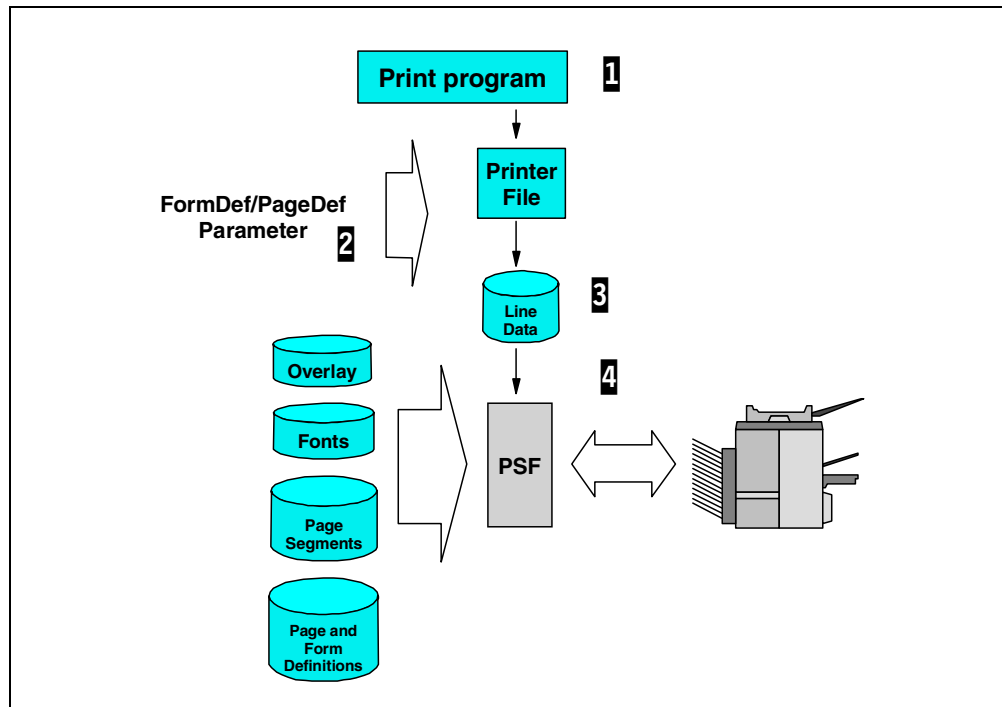

Figure 27. Page and form definition print model

Notes

- 1 The application print program uses a printer file similar to all other AS/400 print processes.
- 2 The DEVTYPE parameter (DEVTYPE *LINE) and the names of the page definition and form definition have to be set at the printer file level.
- 3 A spooled file containing line data is produced (this spooled file cannot be displayed).
- 4 PSF performs the formatting using the page definition and form definition and sends the IPDS data stream to the printer with the AFP resources when needed.

2.1.6 AFP toolbox print model

The AFP toolbox (Figure 28) is part of PrintSuite/400. It is a collection of application program interfaces (APIs) for programmers. AFP toolbox allows developers to produce an AFP data stream while programming in the ILE C, COBOL, or RPG languages.

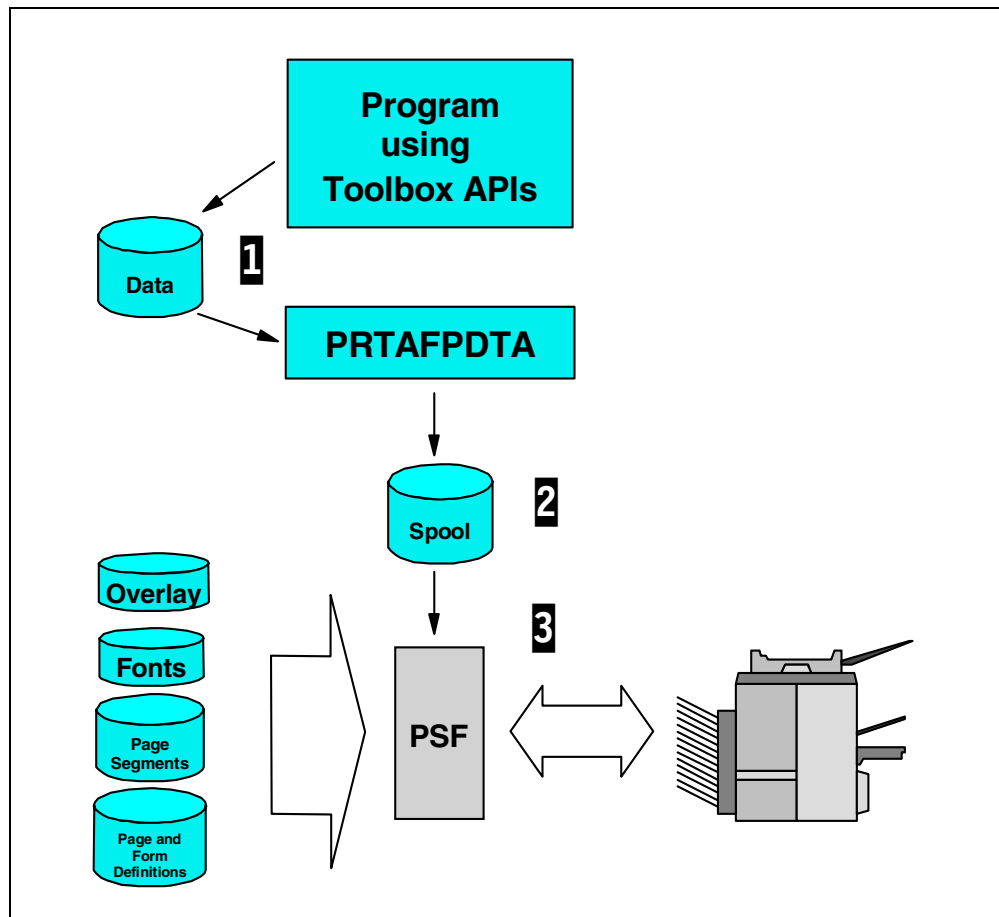

Figure 28. AFP Toolbox print model

Notes

- 1** The application program writes an AFPDS data stream in a physical file.
- 2** The PRTAFPDTA command places the AFPDS as a spooled file in the output queue.
- 3** The AFP resources are added to the print process at print time by PSF/400. It then sends the print data and the resources to the printer.

2.2 AFP resources

AFP resources are elements that PSF can use at print time. The resources are referenced in the spool, not included in the spooled file themselves. The following resources are part of the AFP architecture:

- **Overlays:** A collection of predefined data such as lines, text, boxes, barcodes, images, or graphics. All of these elements build an electronic form that can be merged with the application data at print time. Some elements of the overlay, such as images (in this case, page segments) and graphics, are not in the overlay, but are an external resource of the overlay.
- **Page segments:** Objects that contain images or text information. Page segments can be referenced in an overlay or can be referenced directly from an application. Page segments and all other AFP resources are compatible across system platforms with AFP support.
- **Fonts:** A set of graphic characters of a given size and style. There are different types of font objects on the AS/400 system. Most applications can use fonts with the AS/400 system as printer-resident fonts (Font ID), a code page and character set, or as a coded font. See Chapter 4, “Fonts” on page 89, for detailed information.
- **Form definitions:** AFP resources; specify how the printer controls the processing of a sheet of paper. A form definition can be specified in the printer file. More information about form definitions is available in Chapter 3, “Enhancing your output” on page 67.
- **Page definitions:** AFP resources that contain a set of formatting controls to specify how you want data positioned on the page. This includes controls for the number of lines per printed sheet, font selection, print direction, and mapping fields in the data to positions on the paper. A page definition can be specified at the printer file level.

2.2.1 Creating AFP resources

The overlay design method is different from one product to another. For AFP overlays, there are overlay generators on each platform. AFP Utilities/400 on the AS/400 system or the IBM AFP Printer Driver are the most popular methods. All AFP overlays are compatible across the different platforms and can be used on the AS/400 system. Several software products with a graphical interface are available and provide What You See Is What You Get (WYSIWYG) design of the different AFP resources.

2.2.1.1 Creating overlays and page segments with AFP Utilities/400

AFP Utilities/400 allows you to create overlays and page segments. You can also print data from a database file as an AFP formatted report (using the Print Format Utility).

- The Overlay Utility uses the standard OS/400 interface, and allows you to create an overlay. The Overlay design function includes text, barcode, lines, boxes, shading, page segments, and graphics.
- The Resource Management Utility enables you to create page segments. Most page segments are images from a PC program or from a scanning process. Several steps must be performed before a page segment object is available for the print process. Figure 29 on page 44 shows the process with the image in Image Object Content Architecture (IOCA) (part of the AFP architecture) format using AFPU.

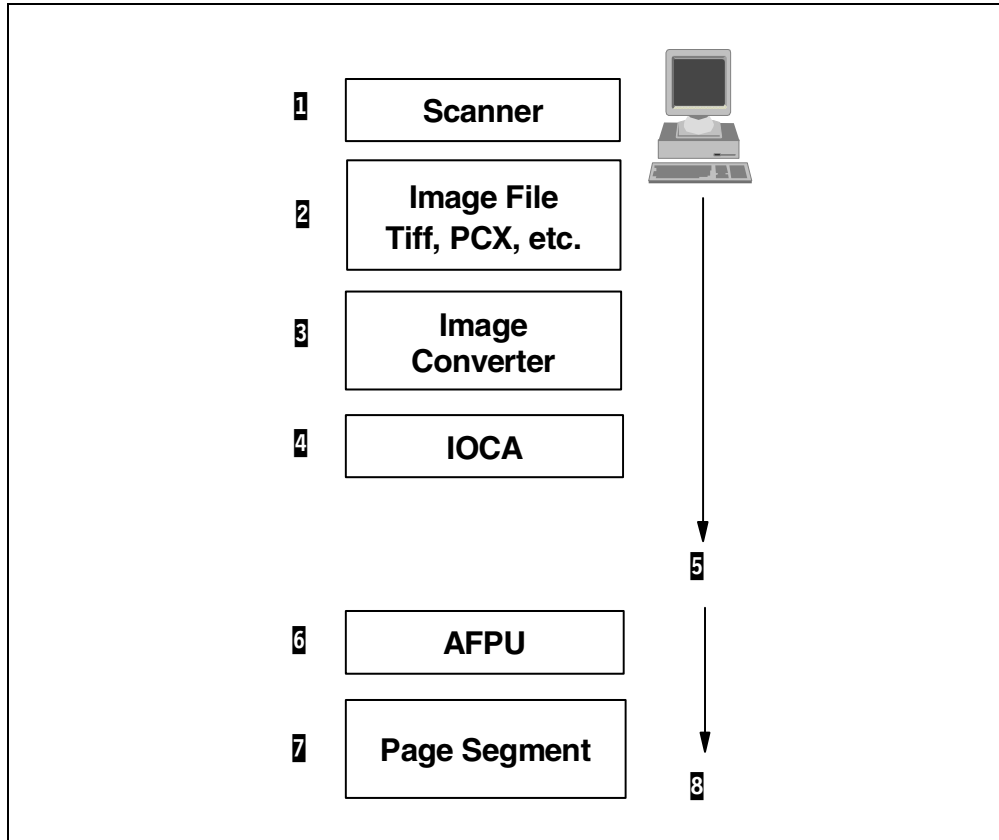

Figure 29. Image process with IOCA image

Notes

- 1 Scan an image with a PC-based program. Common image formats are TIFF, GIF, and PCX.
- 2 Scanned image may be edited with appropriate software to provide better results.
- 3 An image processing program with support for the IOCA image format is required. Many image processing programs can read many different formats and convert the image to another format. Another way is to place the image in a PC application and use the AFP driver to create a page segment, thereby bypassing step 6. For more information, see 5.4, "Creating a page segment" on page 126.
- 4 The image must be in IOCA format.
- 5 Send or copy the image to the shared folder or network drive.
- 6 Option 21 of AFPU allows you to create page segments of different sizes and orientations directly from the IOCA image.
- 7 A page segment object is now available in a library.
- 8 The page segment can be referenced in the DDS printer file.

2.2.1.2 Creating an overlay or page segment with the AFP driver

The AFP driver allows you to create AFP resources, overlays, and page segments from any graphical PC application such as Lotus WordPro, 123, or Freelance, or Microsoft Word. For more information, see 5.4, “Creating a page segment” on page 126.

2.2.2 OEM products

There are many non-IBM choices for form creation for AFP. These range from products that provide for form, font, and image editing to composition systems (for example, DOC/1 and Custom Statement Formatter) that include a form editor as part of the overall product.

2.3 AFP Utilities/400 V4R2 enhancements

The following new enhancements are provided in Version 4.0 Release 2.0:

- View Electronic Form on the PC (Overlay Utility)
- Omit Back Side Page Layout (Print Format Utility)
- Element Repeat (Print Format Utility)
- Form Definition (Print Format Utility)
- Tutorial
- Printer Type Enhancement
- Host Outline Font Support

2.3.1 View electronic form on PC (Overlay Utility)

The Overlay Utility can now dynamically call the Client Access/400 (CA/400) AFP Viewer to view electronic forms on a PC window as they are being designed. The Overlay Utility creates a temporary overlay that can be accessed by the AFP Viewer. This provides a WYSIWYG view of the overlay to the user. The workstation must be a PC attached to the AS/400 system, running Client Access for Windows 95/NT V3R1M3 or later. The Client Access AFP Workbench Viewer must be installed. The user ID specified in the Client Access configuration to access the AS/400 system must be the same as the user ID used to sign on to the AS/400 session or have all object authority. If not, message CPF2189: “Not authorized to object...” is returned.

Figure 30 on page 46 shows the Overlay Utility within AFP Utilities/400. A box and two page segments are placed in the overlay.

```

                                Design Overlay                Columns:  1- 74
Control  . . *VIEW      Source overlay . . . . . VIEW
      *...+...1...+...2...+...3...+...4...+...5...+...6...+...7...
001
002
003
004
005
006      *B001  -----+
007      :                               :
008      :                               :
009      :                               :
010      :                               :
011      :                               :
012      :                               :
013      +-----+
014
015
016
017      *S002      *S003

F3=Exit      F6=Text      F9=Line      F10=Box
F11=Bar code  F21=Element edit  F22=Block edit  F24=More keys
More...

```

Figure 30. Overlay utility from AFPU

When the *VIEW command is typed in the Control field at the top of the display, the AFP Viewer is invoked as soon as you press the Enter key.

Figure 31 shows the AFP viewer display and the overlay.

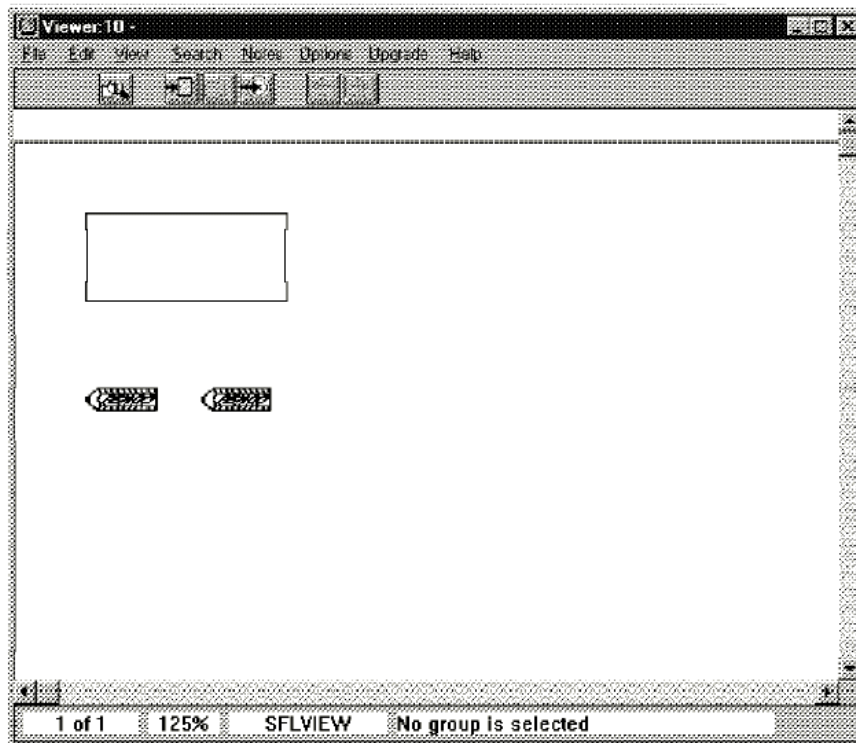

Figure 31. AFP viewer window displaying the overlay

Note: The AFP viewer cannot display a barcode in Bar Code Object Content Architecture (BCOCA) format. The AFP Utilities/400 can produce a barcode in two different ways:

- Barcode for IPDS printer with BCOCA support
- Barcode for IPDS printer without BCOCA support, using Presentation Text Object Content Architecture (PTOCA) support. That is, the barcode lines are drawn as text.

If you want to display a barcode with the AFP Viewer, you can change the printer type in the overlay specifications to a printer type that does not support BCOCA. The online help for the printer type field provides a list of which printer types do and do not support BCOCA.

2.3.2 Print Format Utility ‘Omit Back Side Page Layout’

This option allows you to specify a back side overlay to be printed without the page layout and database data. Effectively, a blank page is inserted into the application data, and the back side overlay is printed on this page (Figure 32).

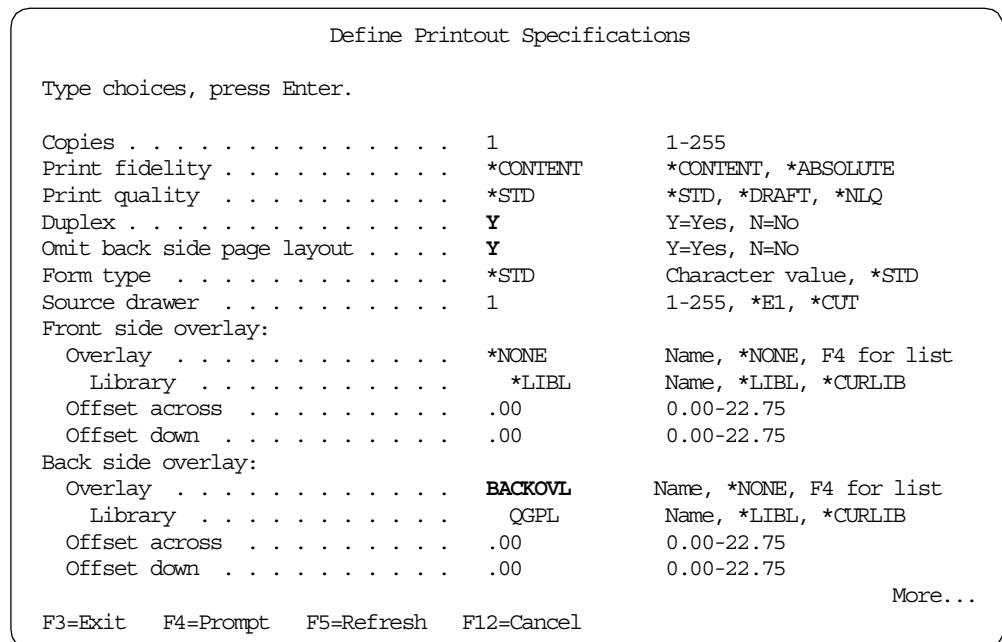

Figure 32. PFU omit back side page layout

2.3.3 Element repeat

Element repeat provides a function to duplicate elements multiple times by pressing a function key and specifying the number of repetitions. The distance from the first element to the next one must be defined for both the across and down directions.

2.3.4 Form definition

A form definition can be selected to print a print format definition. This allows a user with a continuous forms printer to specify the form definition that AFPU uses. AFPU uses the form length and width specified in the PFD definition.

2.3.5 Tutorial

The tutorial is a collection of examples such as overlays, print format definitions, and database files. The new examples can serve as a tutorial for beginning and experienced users. To print the tutorial, type `STRAFPU` and press Enter. Then, from the AFP Utilities/400 menu, select option **14**, and press Enter twice.

2.3.6 Printer type

The printer type list has been updated with new printer types. This allows the user to choose the printer or the resolution of the printer.

2.3.7 Host outline font support

AFPU was able, in the past, to use a resident printer outline font. Support for host-resident outline fonts is now part of AFPU. The user can select an outline font stored on the AS/400 system. The font is downloaded to the printer at print time. See 4.5.1, "Downloading host-resident outline fonts" on page 100, for more information.

Figure 33 shows an additional field for the point size selection. The user can use the Prompt key to show the available font list.

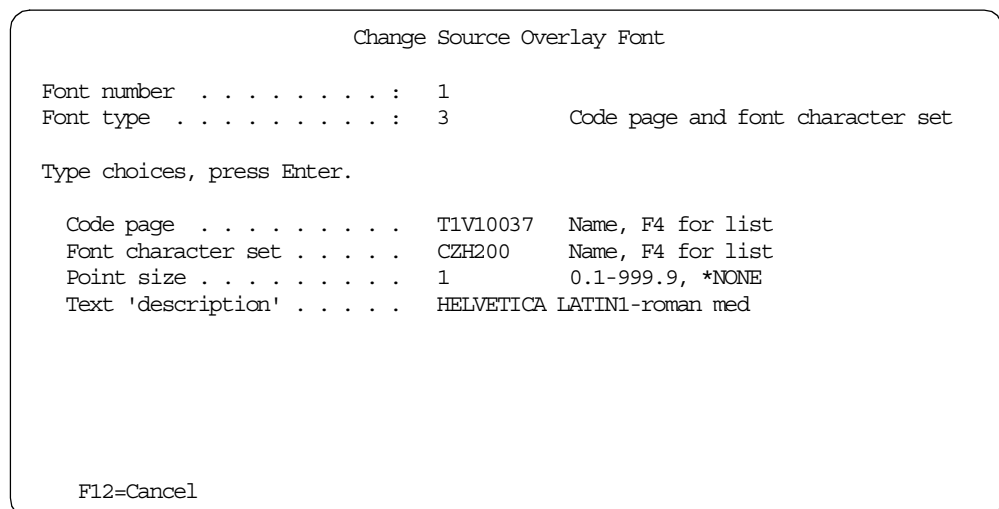

Figure 33. Change Source Overlay Font display

You can select the outline font. No point size information is available for this type of font. The size is determined for you on the Change Source Overlay Font display. The same outline font is used for all sizes. You can now reduce the number of resources needed for an overlay or job (Figure 34).

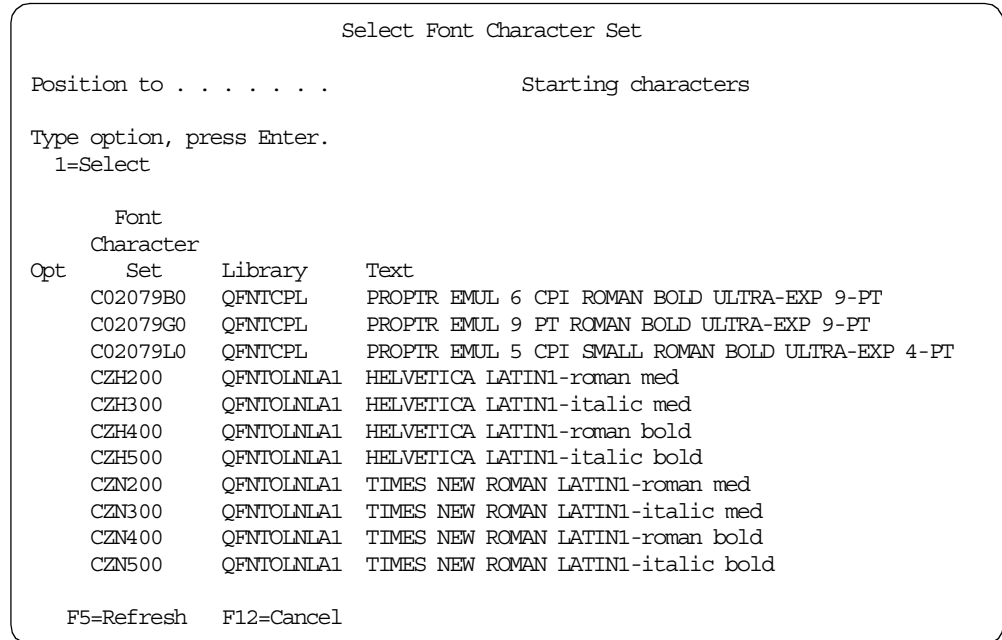

Figure 34. Select Font Character Set display

2.4 Advanced Print Utility (APU) enhancements

Advanced Print Utility (APU) provides an easy way to modify the appearance of spooled data. You can display the spooled data and move the cursor to define an action on this data portion. The new function is now part of APU and versions of APU at V3R2, V3R7, and V4R1 can be refreshed with the same functions. The customer must re-order APU and will receive the refresh version free of charge. The most important function is a new monitor that provides an excellent integration of APU. The following new functions are discussed in this chapter:

- Duplex
- Multiple text
- Outline font
- APU monitor enhancement

2.4.1 Duplex

In the first version, APU was able to place an overlay at the back of the paper sheet. This allowed the user to take advantage of the duplex option of the printer to place a constant electronic form. Variable data could not be printed on the back side of the paper. The new APU duplex option (Figure 35 on page 50) allows you to print data at the front and at the back of the paper sheet to take full advantage of the printer duplex option.

```

SET PAGE LAYOUT OPTIONS
Print Definition. . . : SAMPLE          Page Format. . . . : *DEFAULT
Library. . . . . : MYLIB              Copy. . . . . : *ORIGINAL
Type choices, press Enter.

Input drawer. . . . . *DEFAULT          *DEFAULT, 2, 3, 4
Default line increment *PRTDEF      *INCH      *PRTDEF, *INPUT, Value
Default Column inc. . . *PRTDEF      *INCH      *PRTDEF, *INPUT, Value
Page length. . . . , . "PRTDEF      "INCH      *PRTDEF, *INPUT, Value
Page width . . . . . *PRTDEF      *INCH      *PRTDEF, *INPUT, Value
Top margin (down). . . *PRTDEF      *INCH      *PRTDEF, 0, Value
Left margin (across)'. *PRTDEF      *INCH      *PRTDEF, 0, Value
Page orientation...    *PRTDEF      *PRTDEF, *INPUT, 0, 90...

Duplex printing....          1=Yes, 2=Tumble
Back Overlay....        *NONE          *NONE, Name, F4 for list
  Position across...    *INCH          0, Value
  Position down....     *INCH          0, Value
F3=Exit  F4=Prompt      F12=Cancel  F22=Set Units

```

Figure 35. APU duplex display

Consider these points:

- If duplex printing is enabled, the Back Overlay field must contain the value *NONE because it *cannot* print a constant back overlay.
- If more than one copy (original page) is required in a page format, duplex printing is not possible because there are never two consecutive pages of the same “copy”.

2.4.2 Multiple Text Mapping

APU allows you to define or select a part of a line in the spooled file and map it as a field. You can change the attribute of this mapped area and define a position. APU calculates the actual position automatically. You can change the value to define a new print position. Multiple Text Mapping allows you to place the same mapped data up to four times.

An example is if your customer document includes a five-line address. You can print the address a first time, and also print it (or a part) again on the same sheet of paper four subsequent times.

The Edit Text Mapping display was modified and shows which entry is actually the Multiple Text entry (Figure 36).

```

                                Edit Text Mapping
Type Choices, press Enter.

From Row / Column : 20 / 15
Mapping . . . . : 1 / 2
Length . . . . . : 8
Position across . . : 15 *COL      Value
Position down . . . : 20 *ROW     Value
Font Family . . . . : *PRIDEF    *PRIDEF, Value  F4 for list
  Point Size. . . . :             *CALC, Value
  Bold . . . . . :             1=Yes
  Italic. . . . . :             1=Yes
Rotation. . . . . : *DEFAULT    *DEFAULT, 0, 90,180, 270
Color . . . . . : *PRIDEF      *PRIDEF, Value  F4 for list
F4=Prompt F12=Cancel
F16=Delete F22=Set units                               More...

```

Figure 36. Multiple Text (Part 1 of 2)

Figure 37 shows the second target. All attributes, position, font, rotation, and color may be different from one target to the other one.

```

Type Choices, press Enter.

From Row / Column : 20 / 15
Mapping . . . . : 2 / 2
Length . . . . . : 8
Position across . . : 31 *COL      Value
Position down . . . : 67 *ROW     Value
Font Family . . . . : *PRIDEF    *PRIDEF, Value  F4 for list
  Point Size. . . . :             *CALC, Value
  Bold . . . . . :             1=Yes
  Italic. . . . . :             1=Yes
Rotation. . . . . : *DEFAULT    *DEFAULT, 0, 90, 180, 270
Color . . . . . : *PRIDEF      *PRIDEF, Value  F4 for list
                                                Bottom
F4=Prompt F12=Cancel
F16=Remove additional target

```

Figure 37. APU Multiple Text (Part 2 of 2)

Note these restrictions:

- The Length field may only be changed on the first target and is protected when the second, third, or fourth target is shown.
- The F15=Repeat function key is not enabled if more than one target is specified.
- The F22=Set Units function key is only enabled when the first target is shown and is hidden when the second, third, or fourth target is shown.
- The F16=Delete function key deletes the entire mapping when the first target is shown. When pressed at the second, third, or fourth target, the additional target is removed, but at least the first mapping is still there.

2.4.3 Outline font support

The AS/400 system can download an outline font to IPDS printers. The new version of APU takes advantage of this technology and simplifies the font handling.

After the outline fonts are installed (see 4.4, “How fonts are installed” on page 96), the font database must be updated using the following command:

```
CALL QAPU/QYPUSYNC
```

Now you can select an outline font from the Work with Font display (Figure 38).

Work with Fonts						
Domain : *ALL			*USR, *SYS, *ALL			
Type Options, press Enter.						
1=Add 2=Change 4=Delete			5=Details			
Opt	Font family	Size	Style	Font char. set	Code page	Domai
	TIMES NEW ROMAN	30	Bold-Italic	CON500T0	*DEFAULT	*SYS
	TIMES NEW ROMAN	36	Normal	CON200Z0	*DEFAULT	*SYS
	TIMES NEW ROMAN	36	Italic	CON300Z0	*DEFAULT	*SYS
	TIMES NEW ROMAN	36	Bold	CON400Z0	*DEFAULT	*SYS
	TIMES NEW ROMAN	36	Bold-Italic	CON500Z0	*DEFAULT	*SYS
	TIMES NEW ROMAN Outl	*V	Normal	CZN200	*DEFAULT	*SYS
	TIMES NEW ROMAN Outl	*V	Italic	CZN300	*DEFAULT	*SYS
	TIMES NEW ROMAN Outl	*V	Bold	CZN400	*DEFAULT	*SYS
	TIMES NEW ROMAN Outl	*V	Bold-Italic	CZN500	*DEFAULT	*SYS
F3=Exit F5=Refresh F12=Cancel						

Figure 38. AFP outline fonts in APU

2.4.4 Advanced Print Utility (APU) monitor enhancement

The APU monitor (Figure 39) is part of APU and provides a good way to integrate the APU print definition in your environment. The first version of the monitor was limited in its capabilities. The new monitor provides a major enhancement of APU with a lot of new functions and removes restrictions such as:

- Spooled file name and APU print definition had to be the same.
- The SCS spooled file was set in the hold status only.
- All APU spooled files were placed in one unique output queue.

An APU print definition is required to use the monitor. An example of how to provide a print definition is presented in 3.2.3, “Creating the print definition” on page 72.

The user can now define which elements are relevant for the spooled file selection and what happens to the original SCS spool after APU processing. They can also take more control of the processing themselves. All of these parameters are grouped in an *Action*.

When the monitor finds an action that corresponds with “Selection for input spooled file” (first action sequence), all other sequences from the same action are applied. The action sequences are:

- Selection for input spooled file
- Action for input spooled file
- Actions for output spooled file

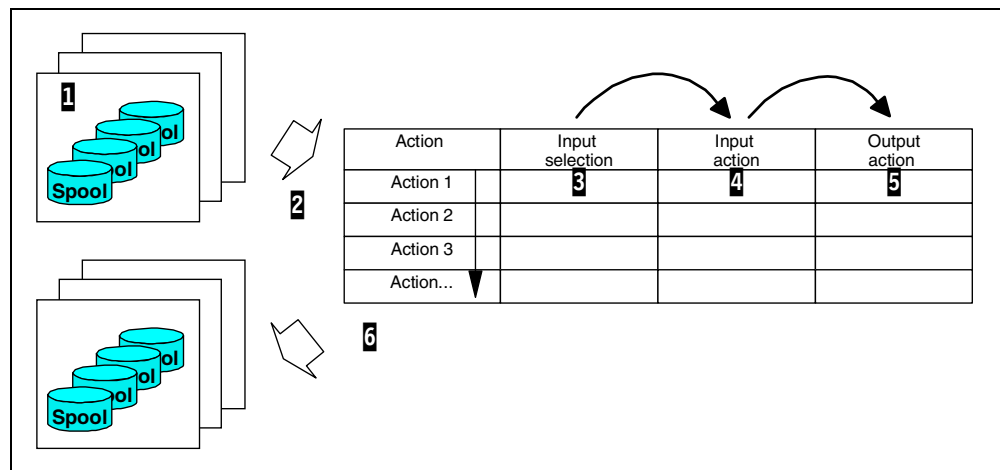

Figure 39. APU monitor

Notes

- 1 The monitor is invoked each time a spooled file arrives in a monitored output queue or if the spooled file status in a monitored queue changes to *RDY. Spooled files with other status codes are not processed.
- 2 The monitor checks the input selection from each action rule in a sequential manner.
- 3 As soon as a spooled file matches the action input selection, the input and output actions are performed. The following actions are ignored. The examples later in this chapter describe how you can create monitor actions.
- 4 The input action is applied after the selection matches a spooled file. The action can be different according to whether APU can complete the job successfully.
- 5 The user can define up to 16 output actions. This allows you, for example, to use several different APU print definitions for the same spooled file.
- 6 One or more spooled files are placed in one or more output queues.

2.4.4.1 Monitor example

Imagine the following customer environment:

Three different output types are provided in three different output queues (OUTQs). Two printers are available, and we want to set the monitor with the following requirements:

- System output (QSYSPRT) must not use an APU print definition.
- All jobs in OUTQ1 must be sent to PRT01.
- All jobs in OUTQ2 and OUTQ3 must be sent to PRT02.
- Application jobs APP01 and APP02 must be sent with a print definition "SAMPLE" applied.

- The application's original spooled files must be placed in the OUTQ "SAVE".
- The original QSYSPRT spooled files must be deleted.

Figure 40 shows the original spooled files before monitoring. The numbers in the figure are used to identify the spool and actions across the different figures of this example.

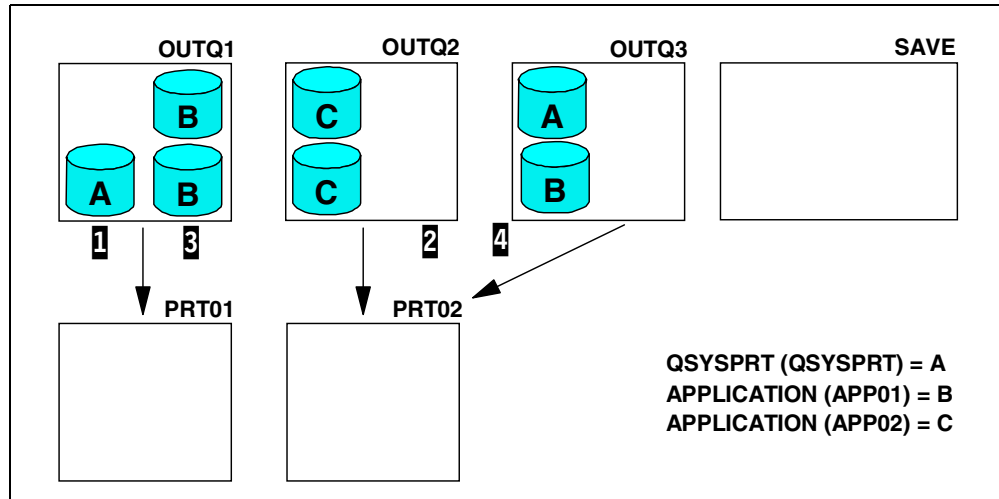

Figure 40. APU monitor example: Before processing

Notes

- 1** All QSYSPRT spooled files from OUTQ1 must be moved to OUTQ PRT01.
- 2** All QSYSPRT spooled files from all other OUTQs must be moved to OUTQ PRT02.
- 3** A print definition is applied to all application spooled files coming into OUTQ1. A new APU spooled file (result of the APU processing) is placed in the output queue PRT01. The original SCS spooled file is moved into OUTQ SAVE.
- 4** A print definition is applied to all application spooled files coming into all other OUTQs. A new APU spooled file (a result of the APU processing) is placed in the output queue PRT02 for each original spooled file. The original SCS spooled file is moved into OUTQ SAVE.

• Monitor actions example

In the example, we define two groups of spooled files: the application spooled files and the QSYSPRT spooled files. Only the application spooled files need an APU print definition. In this case, we want to define the actions for the application spooled files first and then the action for the QSYSPRT spooled files. We can say that all spooled files that are not eligible for APU are moved following the QSYSPRT spooled file actions.

Figure 40 shows which parameters must be defined for each action in the order of the action. The monitor uses the Input selection parameters of the first action to identify whether the spool and selection match. If the input selection parameters do not match the spooled file, the monitor takes the next

action. As soon as the input selection parameters match the spooled file, all action sequences, such as “Input action” and “Output actions” proceed.

The numbers in Table 1 correspond with Figure 40.

Table 1. APU monitor: Action example

Action	Input selection	Input action	Output action
Action for spool 3	File = APP* OUTQ = Outq1	Success = *outq OUTQ = SAVE Failure = *hold	Prtdef = Sample OUTQ = PRT01
Action for spool 4	File = APP* OUTQ = *all	Success = *outq OUTQ = SAVE Failure = *hold	Prtdef = Sample OUTQ = PRT02
Action for spool 1	File = *all OUTQ = Outq1	Success = *outq OUTQ = PRT01 Failure = *hold	Prtdef = *none
Action for spool 2	File = *all OUTQ = *all	Success = *outq OUTQ = PRT02 Failure = *hold	Prtdef = *none

Notes

- 3 Action for the application spooled files in OUTQ1
- 4 Action for all other application spooled files in all monitored OUTQs
- 1 Action for all other spooled files in OUTQ1
- 2 Action for all other spooled files in all other OUTQs

Many other options are possible for each action. You can decide, for example, to delete the original spooled files after processing or hold the spooled files. These options are described later in this section.

• **Example for output queue after processing**

In Figure 41 on page 56, you can see that the two QSYSPRT spooled files (A) are in the correct output queues, and all original application spooled files are in output queue SAVE. The new AFPDS spooled files (outcome from APU processing) are placed in the output queues PRT01 and PRT02, depending on where the original was.

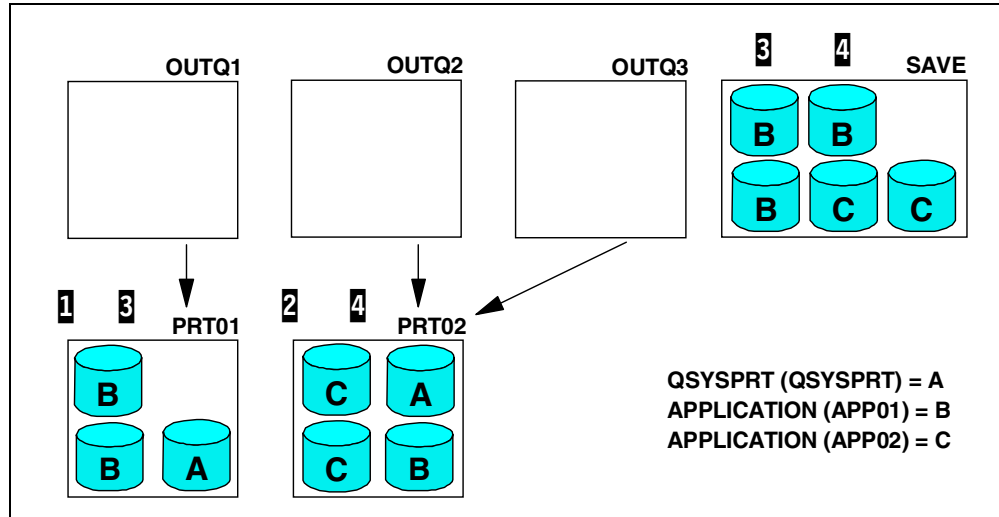

Figure 41. APU monitor example: After processing

Notes

- 1 The QSYSPRT spooled file from OUTQ1 is in the output queue PRT01.
- 2 All QSYSPRT spooled files from the other OUTQs are in the output queue PTR02.
- 3 The original application SCS spooled files from OUTQ1 are in the output queue SAVE. New AFPDS spooled files have been placed in the output queue PRT01. This new spooled file is the result from APU after applying the print definition.
- 4 All other original application SCS spooled files from all other OUTQs are placed in the output queue SAVE. New AFPDS spooled files have been placed in the output queue PRT02. These new spooled files are the result from APU after applying the print definition.

If processing for one spooled file fails, the original spooled file stays in the output queue in *HOLD status following the FAILURE parameter.

2.4.4.2 Using the APU monitor

The following sections can help you set up the APU monitor in your environment. Several configuration steps are needed:

1. Specify the queues to be monitored.
2. Configure the APU monitor.
3. Start the APU monitor.
4. Stop the APU monitor.

A minimum of one action must be defined for the monitor. All *DEFAULT parameters can be used. This action provides compatibility with the first monitor. The APU main menu is shown in Figure 42.

```

APU                                IBM Advanced Print Utility

Select one of the following:

Build and Test APU Print Definitions
  1. Work with Print Definitions
  2. Work with Spooled Files

Run APU in Batch Mode
  3. Work with APU Monitor
  4. Start APU Monitor
  5. End APU Monitor

Configure APU
  6. Set APU Defaults
  7. Work with Fonts
  8. Configure APU Monitor Action

Selection or command
====>

```

Figure 42. APU main menu

2.4.4.3 Specifying the queues to be monitored

The first task is to define which OUTQs must be monitored. The Work with APU Monitor window is shown in Figure 43. Now you can add or remove OUTQs in the list. You need to add only the queue where the spooled file action is performed with an APU print definition. If a spooled file comes in other OUTQs, no action is performed from the APU monitor. After all queues are added, you need to configure the APU monitor actions.

```

                                Work with APU Monitor

APU Monitor status . : Active   The output queues in the list are
                                currently monitored by APU

Type options, press Enter.
  1=Add  4=Remove

Output
Opt  queue      Library  Text
---  -
OUTQ1  QGPL      Input  OUTQ1
OUTQ2  QGPL      Input  OUTQ2
OUTQ3  QGPL      Input  OUTQ3

F3=Exit  F5=Refresh  F12=Cancel

```

Figure 43. Work with APU Monitor

2.4.4.4 Configuring the APU monitor action

This section describes each part of a monitor action. Each action has the following three parts:

- Selection for input spooled file
- Action for input spooled file
- Action for output spooled file

The Configure APU Monitor Action display (Figure 44) allows you to create, change, copy, and delete actions. Each action is performed in the sequence shown on the display by the APU print engine.

Note: If you want the monitor to work in a similar manner to the first version, a minimum of one action must be defined for the monitor. All *DEFAULT parameters can be used. This action only provides compatibility with the first monitor. You must use Option 1 (Add), but you do not need to define an entry. You must give a sequence number (for example, 10) and text (for example, "Action for compatibility mode"). Press Enter, and the action is created.

```

                                Configure APU Monitor Action

Type options, press Enter.
  1=Create  2=Change  3=Copy  4=Delete

Opt   Sequence   Text
  1
  10      Qsysprt spool in OUTQ1
  20      Qsysprt spool in all other OUTQ's
  30      QPJOB spool in OUTQ1
  40      QPJOB spool in all other OUTQ's
  50      All other spool in OUTQ1
  60      All other spool in all other OUTQ's

F3=Exit  F5=Refresh  F12=Cancel  F22=Renumber Sequence

```

Figure 44. Configure APU Monitor Action display

The F22 key can be used to renumber the entries automatically. The renumbering uses an increment of 10 unless the number of records is greater than 999. In this case, the increment is calculated depending on the number of records.

At run time, the monitor retrieves the SCS spooled file attributes and tries to find a matching entry. The monitor evaluates the entries in the order of the user-entered sequence numbers. As soon as the monitor finds a match, it processes the spooled file according to the rest of the action information.

If it does not find a match in the table, the spooled file cannot be processed, a message is sent to the monitor's job log, and the spooled file stays in the OUTQ.

2.4.4.5 Creating an action group entry

As soon you create or modify an action, the screen shown in Figure 45 appears. You can select one or more action entries. The print engine performs all three entries for each action.

```

                                Create Action Entry

Type choices, press Enter.

Sequence . . . . . 10                Number
Text . . . . . QSYSPRT spool in OUTQ1

Type options, press Enter.
  1=Select

Opt  Function

  1  Define selection for input spooled file
  1  Define action for input spooled file
  1  Define action for output spooled file

F12=Cancel

```

Figure 45. Selecting one or more action entries

2.4.4.6 Defining selection criteria for the input spooled file

The first display (Figure 46) is used to define selection criteria for the input spooled file. In other words, this display is used to select the SCS spooled file that is processed as input. From this display, the user can decide which spooled file attributes the monitor should use to match an SCS spooled file.

When the APU Monitor is running, it looks for a file or files with the attributes that are provided on this display. If APU finds a match between the attributes you enter here and an input spooled file, it processes both entries: *Action for Input Spooled File* and *Action for Output Spooled File*.

```

                                Define Selection for Input Spooled File

Sequence . . . . . : 30
Text . . . . . : QPJOB spool in OUTQ1

Type choices, press Enter.

File . . . . . QPJOB*      Name, Generic*, *ALL
Output queue . . . . . OUTQ1  Name, Generic*, *ALL
  Library . . . . . *LIBL    Name, *LIBL
User . . . . . *ALL        User, Generic*, *ALL
User Data . . . . . *ALL    User Data, Generic*, *ALL
Form Type . . . . . *ALL    Form Type, Generic*, *ALL
Program . . . . . *ALL     Name, Generic*, *ALL
  Library . . . . .         Name, *LIBL

F12=Cancel

```

Figure 46. Define Selection for Input Spooled File display

The following values can be used by APU to select the input spooled file:

- **Spooled file name:** Can be a specific name, a generic name, or *ALL.
- **Output queue:** Can be a specific output queue, a generic name, or *ALL.
- **User:** Can be a specific user, a generic set, or *ALL.
- **User Data:** Can be a specific entry in the user data field, generic data, or *ALL.
- **Form Type:** Can be a specific form, a generic form, or *ALL.
- **Program name:** Can be a specific program, a generic program, or *ALL.

2.4.4.7 Defining the action for an input spooled file

With the next entry (Figure 47), a user can define the action for an input spooled file. This allows a user to tell the monitor what to do with the original SCS spooled file after the monitor processes the spooled file.

The user can give instructions to hold, delete, do nothing, or move the SCS spooled file to another output queue. These instructions can be defined differently depending on whether it is a successful completion or a failed completion from the processing.

Define Action for Input Spooled File

```

Sequence . . . . . : 30
Text . . . . . : QPJOB spool in OUTQ1

Type choices for input spooled file after successful
or failed processing respectively, press Enter.

Success . . . . . *OUTQ          *NONE, *HOLD, *DELETE, *OUTQ
  Output queue . . . . . OUT1          Name
    Library . . . . . *LIBL          Name, *LIBL

Failure . . . . . *HOLD          *NONE, *HOLD, *DELETE, *OUTQ
  Output queue . . . . .          Name
    Library . . . . .          Name, *LIBL

F12=Cancel

```

Figure 47. Define Action for Input Spooled File display

APU moves the input spooled file to the output queue defined in the Success or Failure fields, depending on the result. It places the file in one of the four status conditions that were previously shown.

2.4.4.8 Defining action for output spooled file example

The user can enter information on two displays (which make up an action group) that describes the tasks to be performed by the print engine. The user can define between one and 16 entries for the output spooled file, so it is possible to run several print definitions for one unique SCS spooled file.

We can take the first example of the APU monitor and add the following additional requirements.

Imagine that there is a second location (Paris). Now we must identify which document is for the local system and which one is for the other location. This is possible with the conditional option in the print definition. The user must define two different print definitions. Each uses conditional processing to select which document is in the new spooled file (each print definition produces one spooled file).

For the monitor, the user must define two actions for output spooled files. Each action refers to one of the print definitions. At run time, the print engine runs both print definitions with a different output queue for each.

Table 2 shows the same example with the additional output actions.

Table 2. Action example

Action	Input selection	Input action	Output action 1/2	Ouput action 2/2
Action for spool 3	File = APP* OUTQ = Outq1	Success = *outq OUTQ = SAVE Failure = *hold	Prtdef = Sample OUTQ = PRT01	Prtdef = Sample2 OUTQ = REMLOC 5
Action for spool 4	File = APP* OUTQ = *all	Success = *outq OUTQ = SAVE Failure = *hold	Prtdef = Sample OUTQ = PRT02	Prtdef = Sample2 OUTQ = REMLOC 6
Action for spool 1	File = *all OUTQ = Outq1	Success = *outq OUTQ = PRT01 Failure = *hold	Prtdef = *none	
Action for spool 2	File = *all OUTQ = *all	Success = *outq OUTQ = PRT02 Failure = *hold	Prtdef = *none	

Notes

- 3 Action for the application spooled files in OUTQ1. An additional output action sequence is added.
- 5 A second print definition is applied with a different output queue.
- 4 Action for all other application spooled files in all monitored OUTQs.
- 6 An additional output section sequence is added. A second print definition is applied with a different output queue.
- 1 Action for all other spooled files in OUTQ1.
- 2 Action for all other spooled files in all other OUTQs.

Note: If an empty or incorrect output action is provided, the action for the Input SCS spooled file follows the failed procedure.

Figure 48 on page 62 shows how the actions have been executed from the monitor. Due to the conditional processing of the print definition, the application spooled file has been split between the local and Paris output queues. The white spooled file represents that only the location dependent data is present.

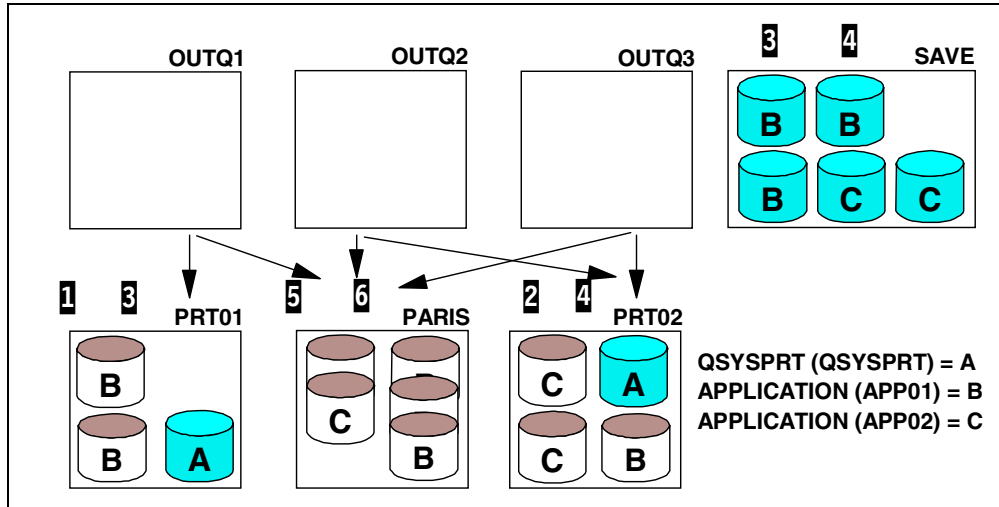

Figure 48. Spooled file location after processing

Notes

- 1 The QSYS PRT spooled files from OUTQ1 are in PRT01 OUTQ.
- 2 All QSYS PRT spooled files from the other OUTQs are in PRT02 OUTQ.
- 3 All original application spooled files from OUT1 are placed in OUTQ SAVE after processing. A new AFPDS spooled file has been placed in PRT01 for each spooled file formatted with the print definition "SAMPLE".
- 5 A second AFPDS spooled file formatted with the print definition "SAMPLE2" has been placed in the output queue "REMLOC" for each spooled file.
- 4 All other original application spooled files from all other OUTQs are placed in OUTQ SAVE after processing. A new AFPDS spooled file has been placed in PRT02 for each spooled file formatted with the print definition "SAMPLE".
- 6 A second AFPDS spooled file formatted with the print definition "SAMPLE2" has been placed in the output queue "REMLOC" for each spooled file.

2.4.4.9 Defining an action for the output spooled file

On the Define Action for Output Spooled File display (Figure 49), specify the name, library, and user-defined parameters for the program to be called by APU before, during, or after processing.

```

                                Define Action for Output Spooled File
Sequence . . . . . : 30
Text . . . . . : QPJOB spool in OUTQ1
Action . . . . . : 1 / 1
Panel . . . . . : 1 / 2

Type choices, press Enter.

User exit before . . . *NONE                Name, *NONE
  Library . . . . .      Name, *LIBL
  User parameter . . .   Value
Print Definition . . . SAMPLE                Name, *SPOOLFILE, *NONE
  Library . . . . .      *PRIDEFLIB          Name, *PRIDEFLIB, *LIBL
  Run option . . . . .  *NORMAL              *NORMAL, *NOCOPY, *REPRI
User exit middle . . . *NONE                Name, *NONE
  Library . . . . .      Name, *LIBL
  User parameter . . .   Value
Output device . . . . . *JOB                Name, *JOB
Output queue . . . . . PRT01                Name, *DEV, *SPOOLFILE
  Library . . . . .      *LIBL                Name, *LIBL

F12=Cancel                      F15=Next action

```

Figure 49. Define Action for Output Spooled File display

The parameters are explained here:

- **User exit before:** The User exit before field contains the name, library, and user-defined parameters for the program to be called by the print engine before it starts to initialize the APU environment.
- **Print definition:** These lines contain values for the library where the print definition is stored and for the run option. The following values can be entered for the run option. If you specify *NONE on the print definition field, any value you place here is ignored.
 - ***NORMAL:** This is the default value that instructs the print engine to perform all print engine phases. If this is the first or only action group defined in this entry, *NORMAL is the only valid value for that field. Therefore, on the first action group, this field may not be changed. A complete overview of the print engine phases is provided in 2.4.5, “Print engine” on page 66.
 - ***NOCOPY:** If the user wants to apply different print definitions with the same spooled file, this value instructs the print engine to skip the CPYSPL phase, or to reuse the already prepared input spooled file database instead. All other phases are performed normally. This value is only valid if specified in the second or later action group.
 - ***REPRINT:** If the user wants to apply the same print definition multiple times to the same spooled file, this value instructs the print engine to skip the CPYSPL, EXTMID, and GENAFP phases. It re-uses the already prepared output AFPDS database instead. This value is only valid if it is specified in the second or later action group.

Note: It is important to understand the run option. The run option allows you to reduce the number of processing steps. This can influence the performance.

- **User exit middle:** This field contains the name, library, and user-defined parameters for the program to be called by the print engine after the input spooled file has been copied to the database.
- **Output device:** Specify the name of the device on which the spooled file is to be printed. The value *JOB causes APU to place the output spooled file in the output queue of the current device.
- **Output queue:** Contains the name of the output queue where the spooled file is to be placed. *SPOOLFILE tells APU to place the output file in the same output queue where the input spooled file was found. *DEV has APU place the file into the output queue of the device specified in the Output device field.

```

                                Define Action for Output Spooled File

Sequence . . . . . : 30
Text . . . . . : QPJOB spool in OUTQ1
Action . . . . . : 1 / 1
Panel . . . . . : 2 / 2

Type choices, press Enter.

File . . . . . *SPOOLFILE      Name, *PRTDEF, *SPOOLFILE
User Data . . . . . *SPOOLFILE  User Data, *PRTDEF, *SPOOLFILE
Form Type . . . . . *SPOOLFILE  Form Type, *PRTDEF, *SPOOLFILE
Hold . . . . . *NO             *YES, *NO
Save . . . . . *NO             *YES, *NO, SPOOLFILE
Output bin . . . . . *DEVVD     1-65536, *DEVVD, *SPOOLFILE
User exit after . . . . *NONE     Name, *NONE
  Library . . . . .      Name, *LIBL
  User parameter . . . . Value

                                F12=Cancel                                F15=Next action

```

Figure 50. Define Action for Output Spooled File display

The display shown in Figure 50 is used to specify what is to be done after processing a file:

- **File:** The File field is the name of the output spooled file. *PRTDEF is used if you want the output spooled file to have the same name as the print definition. *SPOOLFILE is used if you want the output spooled file to have the same name as the input spooled file.
- **User data:** The user data field specifies the character string that is attached to the output file. *PRTDEF tells APU to set the value of this field to the name of the processed print definition. *SPOOLFILE tells APU to set this character string value to the data string of the input spooled file.
- **Form Type:** The Form Type field names the form type of the output spooled file. *PRTDEF tells APU to set the form type to the name of the processed print definition. *SPOOLFILE sets the form type of the output file to the form of the input file.
- **Hold:** The Hold field holds a value specifying the status that the output spooled file is to have. *NO sets the value to READY; *YES sets the value to HELD.

- **Save:** The Save field specifies what happens to the output spooled file. *NO does not save the file; *YES saves the file. *SPOOLFILE performs the same action to the output spooled file as was done to the input spooled file.
- **Output bin:** The Output bin field identifies the output bin of the printer. *DEV D sends the output to the bin that is specified as the printer device default. *SPOOLFILE is used to specify the output bin of the input spooled file.
- **User exit after:** The User exit after field contains the name, library, and user-defined parameter for the program to be called by APU after the output spooled file has been created.

2.4.4.10 Applying a print definition manually or with a command

Option 2 of the APU main menu allows you to apply a print definition to a spooled file manually. All parameters are adapted following the new monitor capability. The APYPRTDEF command has the same capability.

2.4.4.11 Starting the APU monitor

The display shown in Figure 51 allows you to start one monitor and display the number of monitors that are already started.

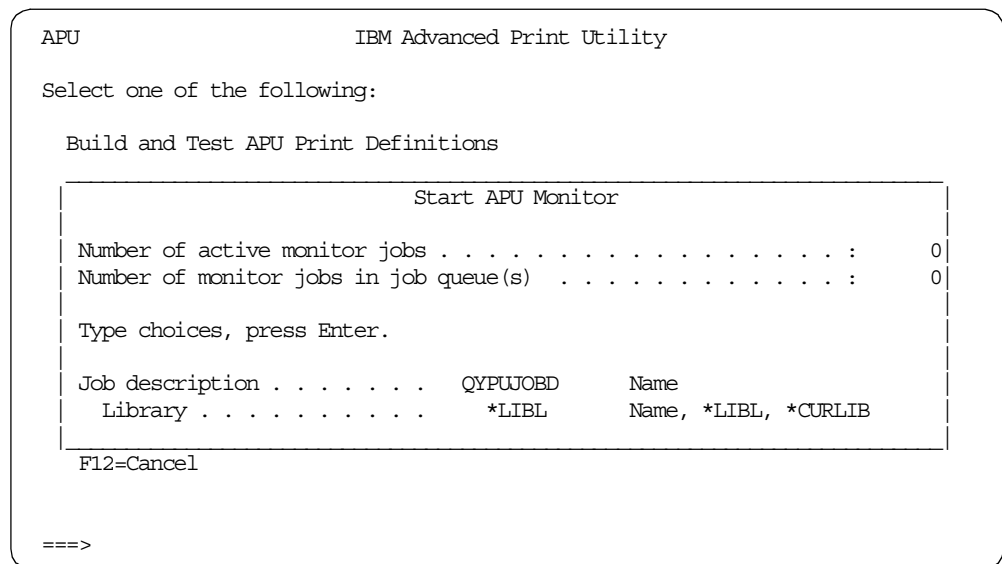

Figure 51. Start APU monitor display

Type the names of the job description and the library where it is stored. Then, press Enter to start the monitor. After you press Enter, you return to the Main menu. A message telling you that the APU Monitor is started is shown on the bottom of the display.

2.4.4.12 Stopping the APU monitor

To stop the APU Monitor, return to the APU main menu, and select Option 5 (End APU Monitor).

Note these considerations:

- The maximum number of entries is 9999.
- The maximum number of output action groups per entry is 16.

2.4.5 Print engine

The following steps refer to phases of the APU print engine. They include a table of mnemonics for the current and new phases of the engine. The current release of the engine uses four phases, which are indicated at run time using status messages. The new release will have eight phases, which will be indicated in a similar way at run time.

1. Call the user exit program “before”:

```
CURRENT: not available
NEW:     EXTBEF   (***)
```

2. Set up the internal environment:

```
CURRENT: INZENV   (***)
NEW:     INZENV   (=== ***)
```

3. Create an internal spooled file database using the Copy Spooled File (CPYSPLF) command:

```
CURRENT: CPYSPL   (--- ***)
NEW:     CPYSPL   (=== ***)
```

4. Call the user exit program “middle”:

```
CURRENT: not available
NEW:     EXTMID   (=== ***)
```

5. Process the input and create an AFPDS output database:

```
CURRENT: GENAFP   (--- ***)
NEW:     GENAFP   (=== ***)
```

6. Convert the database to a spooled file using the Print AFP Data (PRTAFPDTA) command:

```
CURRENT: PRTAFP   (--- ***)
NEW:     PRTAFP   (=== ***)
```

7. Call the user exit program “after”:

```
CURRENT: not available
NEW:     EXTAFT   (=== ***)
```

8. Perform a post-processing action on the SCS input spooled file:

```
CURRENT: not available
NEW:     INPACT   (=== ***)
```

Chapter 3. Enhancing your output

This chapter demonstrates how you can transform a standard AS/400 spooled file and enhance the output without any application modifications. The following print applications are used in this chapter:

- Advanced Print Utility (APU)
- Page Printer Formatting Aid (PPFA)

APU and PPFA are part of the AFP PrintSuite for AS/400 family of print products that enable existing applications to take advantage of Advanced Function Presentation (AFP). In this chapter, we show a simple example of output enhancement. Both AFP and PPFA can provide far more complex formatting. Figure 52 shows a typical output from a standard AS/400 SCS spooled file. Using plain paper and the Courier font results in a dull document appearance.

Cedric & Marc Ltd, 64 Dream Avenue Doerfl1 CO 80301				
Phone	012 008 1988			
Fax	006 001 1992			
INVOICE NR. 123456		Caffee "Chez Brigitte"		
Customer Nr. 778899		No return Avenus 12		
Boulder, 02.06.1995		8900 Parade Plaza		
		Wonderland		
05.11.98	1205 Espresso pack	1	70.00	70.00
12.11.98	1206 Espresso pack plus	2	80.00	160.00
15.11.98	1000 Plastic tab (100)	10	7.00	70.00
17.11.98	1205 Espresso pack	3	70.00	210.00
25.11.98	2500 Caffee Edith	6	60.00	360.00
26.11.98	2501 Caffee OP10 II	8	25.00	200.00
27.11.98	2502 Caffee Filter (20)	5	14.00	70.00
29.11.98	2505 Caffee Vanil flavor	1	70.00	70.00
01.11.98	2600 Espress. Cup "Edith"	2	70.00	140.00
05.11.98	1002 Plastic cup (10)	300	1.10	330.00
11.11.98	3000 Decaff. pulver	3	70.00	210.00
12.11.98	5000 Maintenance set	10	20.00	200.00
17.11.98	2509 Espresso spec. "GENI"	1	70.00	70.00
22.11.98	5001 Optional Requests "ALAN"	2	70.00	140.00
23.11.98	5002 Preparation for Presentation	2	70.00	140.00
Total			\$	2440.00

Figure 52. Output from a standard SCS spooled file

3.1 How your print output could look

Taking advantage of a laser printer and either APU or PPFA, we can produce a more attractive document (Figure 53).

Cedric & Marc Ltd,
64 Dream Avenue
Doerfli CO 80301

Phone 012 008 1988
Fax 006 001 1992



INVOICE NR. 123456

Customer Nr. 778899
Boulder, 02.06.1995

Caffee "Chez Brigitte"
No return Avenue 12
8900 Parade Plaza
Wonderland

Date	Description	Qty	Rate	Total
05.11.98	1205 Espresso pack	1	70.00	70.00
12.11.98	1206 Espresso pack plus	2	80.00	160.00
15.11.98	1000 Plastic tab (100)	10	7.00	70.00
17.11.98	1205 Espresso pack	3	70.00	210.00
25.11.98	2500 Caffee Edith	6	60.00	360.00
26.11.98	2501 Caffee OP10 II	8	25.00	200.00
27.11.98	2502 Caffee Filter (20)	5	14.00	70.00
29.11.98	2505 Caffee Vanil flavor	1	70.00	70.00
01.11.98	2600 Espress. Cup "Edith"	2	70.00	140.00
05.11.98	1002 Plastic cup (10)	300	1.10	330.00
11.11.98	3000 Decaff. pulver	3	70.00	210.00
12.11.98	5000 Maintenance set	10	20.00	200.00
17.11.98	2509 Espresso spec. "GENI"	1	70.00	70.00
22.11.98	5001 Optional Requests "ALAN"	2	70.00	140.00
23.11.98	5002 Preparation for Presentation	2	70.00	140.00

Total \$ 2440.00

Figure 53. Enhanced output

Only a few changes have been made to enhance the page presentation:

- A Gothic font was used instead of Courier 10.
- A Helvetica 14-point font was used for the invoice number.
- An overlay was used comprised of:
 - Lines
 - Boxes
 - Logo

3.2 Using Advanced Print Utility (APU)

APU provides the easiest way to modify the presentation output of an existing application, without changing that application. You can display your spooled file on the screen and modify the appearance of the data. No DDS changes or programming is required. You only need to know your application output and be familiar with the AS/400 system. This section describes a simple example with APU.

3.2.1 APU environment

APU produces AFPDS spooled files from your original SCS spooled file. These may be printed on IPDS printers, and on ASCII printers using host print transform. For more information, see Chapter 6, “Host print transform” on page 137. Table 3 shows which components are required.

Table 3. Component requirement for APU

Components	IPDS printer	HPT attached printer
1 APU	YES	YES
2 PSF/400	YES	NO
3 IBM AFP Font Collection	Recommended	Recommended
4 IBM AFP Printer Driver	Recommended	Recommended

Notes

- 1 APU is part of PrintSuite/400 and must be installed on each system to create or apply an APU print definition.
- 2 PSF/400 is required using an IPDS printer configured as AFP=*YES. PSF/400 is not required for ASCII printer using host print transform (HPT).
- 3 APU uses downloaded fonts in AFP Raster or Outline format. The QFNTCPL library is supplied with OS/400 but contains fonts in 240-pel resolution. If the printer uses 300-pel resolution, font substitution occurs. The IBM AFP Font Collection contains additional fonts in both resolutions (see 4.3, “Which fonts are available” on page 93).
Note: Pel is an abbreviation for picture element or pixel
- 4 APU provides you with the ability to draw lines and boxes. For greater functionality, you can use a tool, such as the AFP driver, to create an electronic form (overlay). For more information about the AFP driver, see Chapter 5, “The IBM AFP Printer Driver” on page 117.

3.2.2 Setting up APU

After APU and all the required components are installed, you must set the APU default parameters and synchronize the font database.

3.2.2.1 Fonts

APU does not use printer resident fonts. Instead, it uses AS/400-resident fonts (character sets) in either raster or outline format. See Chapter 4, “Fonts” on page

89, for additional information about AFP fonts and how PSF/400 provides font management. Follow this process for using fonts:

1. After all your font libraries are installed, you must add them to your library list by using the ADDLIBL command. Alternatively, you can change the QUSRLIBL system value to reference them.

2. The following command synchronizes the font database:

```
CALL QAPU/QYPUSYNC
```

3. This identifies the system fonts to APU. When the database is synchronized, type the following command to access the APU menu:

```
GO QAPU/APU
```

The display shown in Figure 54 appears.

```
APU                                IBM Advanced Print Utility

Select one of the following:

Build and Test APU Print Definitions
  1. Work with Print Definitions
  2. Work with Spooled Files

Run APU in Batch Mode
  3. Work with APU Monitor
  4. Start APU Monitor
  5. End APU Monitor

Configure APU
  6. Set APU Defaults
  7. Work with Fonts
  8. Configure APU Monitor Action

Selection or command
====>

F3=Exit   F4=Prompt   F9=Retrieve   F12=Cancel   F16=System main menu
F23=Set initial menu
```

Figure 54. APU main menu

4. Display the font list using option 7 (Work with Fonts) on the APU menu. Figure 55 shows the Work with Fonts display. Note that the Domain parameter must be changed to *ALL if you want to see all the fonts that are available to APU.

```

Work with Fonts

Domain . . . . . : *ALL                *USR, *SYS, *ALL

Type Options, press Enter.
  1=Add  2=Change  4=Delete  5=Details

Opt Font family      Size Style      Font
char. set  Code page  Domai

    GOTHIC UPPER      6 Normal    COL00GSC  T1000893  *SYS
    GOTHIC UPPER      6 Normal    COL00GUC  *DEFAULT  *SYS
    GOTHIC UPPER      8 Normal    COL0GUL5  *DEFAULT  *SYS
    GOTHIC UPPER     10 Normal    COL0GUL2  *DEFAULT  *SYS
    GOTHIC UPPER     12 Normal    COL0GUL0  T1L00FMT  *SYS
    GOTHIC13          9 Normal    COD0GT13  *DEFAULT  *SYS
    HELVETICA         6 Normal    COH20060  *DEFAULT  *SYS
    HELVETICA         6 Italic    COH30060  *DEFAULT  *SYS
    HELVETICA         6 Bold      COH40060  *DEFAULT  *SYS
    HELVETICA         6 Bold-Italic COH50060  *DEFAULT  *SYS
    HELVETICA         7 Normal    COH20070  *DEFAULT  *SYS
    HELVETICA         7 Italic    COH30070  *DEFAULT  *SYS

F3=Exit  F5=Refresh  F12=Cancel

```

Figure 55. APU font list

3.2.2.2 APU default setup

To setup the APU default, follow this process:

1. The Set APU Defaults display is shown when you select option 6 on the main APU menu. These defaults are used to set the print definition attributes at creation time. You cannot create a print definition if no defaults are provided.
2. Before you set or change any parameters, check that all your font resource libraries are in your library list. Otherwise, you will not have all the fonts or code pages available for selection.

An example is shown in Figure 56.

```

Set APU Defaults

Type choices, press Enter.

Unit of measure . . . . *INCH                *INCH, *CM, *ROWCOL, *UNITS
Decimal point character . . . . . or ,
Font family . . . . . COURIER COMP          Value          F4 for List
Color . . . . . *DEFAULT                    *DEFAULT, Value F4 for List
Definition library . . . APUDEF              Name
Code Page . . . . . T1V10037                Name          F4 for List

Addl. resource libs. . . AFPRSC              Name
                                                Name
                                                Name
                                                Name

Job description . . . . QYPUOBD              Name
Library . . . . . *LIBL                      Name, *LIBL

F3=Exit  F4=Prompt  F12=Cancel

```

Figure 56. APU default

3. Choose a Font family as the default font by pressing F4 for a list.
4. We recommend that you create a separate library in which to store your print definitions. In the example, this is called APUDEF.
5. The code page depends on the language of your country. The system value QCHRID gives the character ID and code page of your system. The “Printer Resident to Host Resident Code Page Mapping” table in Appendix D of *Printer Device Programming*, SC41-5713, provides a conversion table between the system code page and the AFP code page. The system code page in this example is 37, and the AFP code page needed for APU is T1V10037.
6. In the Additional resource libraries parameter, type the name of the library or libraries containing your overlays and page segments. APU can only use the resources placed in these libraries.

3.2.3 Creating the print definition

To create the print definition, follow these steps:

1. Select option **1** from the APU menu to access the display as shown in Figure 57.

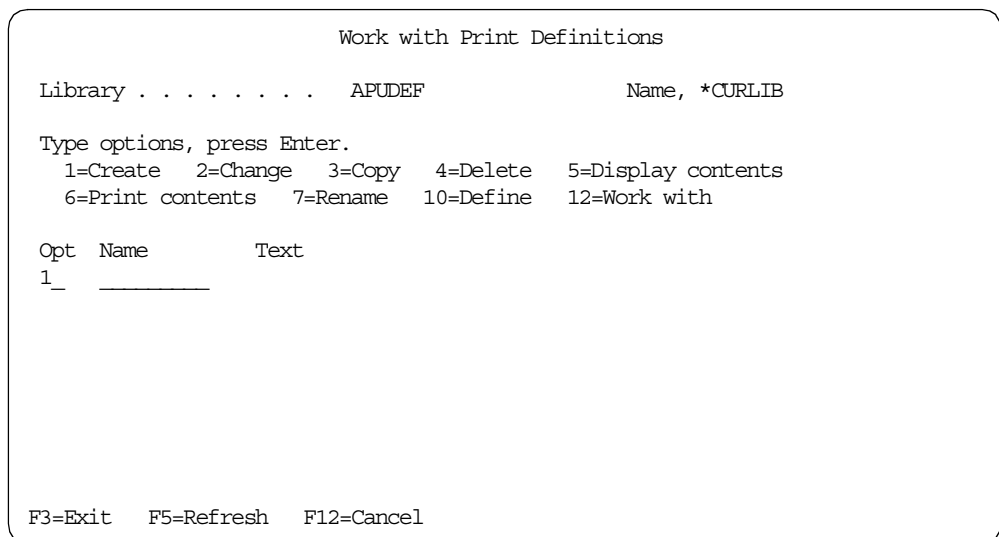

Figure 57. Work with Print Definitions display

2. Create a print definition by selecting option **1**. The Create a Print Definition display is shown in Figure 58.
3. Type a name and descriptive text. Press Enter to finish *creating* the print definition.

```

                                Set Print Definition Attributes

Print Definition . . . : ENHANCE
  Library . . . . . :  APUDEF

Type choices, press Enter.

Default font family . .  GOTHIC COMP          *APUDFT, Value   F4 for List
Point size . . . . .   12                    *CALC, Value
Bold . . . . .                               1=Yes
Italic . . . . .                               1=Yes

Default Color . . . . . *APUDFT              *APUDFT, Value   F4 for List

Addl. resource libs. .  OVERLAY               Name
                                                                Name
                                                                Name
                                                                Name

F3=Exit  F4=Prompt  F12=Cancel

```

Figure 60. Set Print Definition Attributes (Part 2 of 2)

8. In this example, we pressed F4 next to the Default font family field and selected a monospaced font. Press Enter to complete the “Define a Print Definition” part.

The Gothic font is the *default* font in your Print Definition. You can select different fonts for parts of the document, which are described in the “Map Text” step later in this section.

9. Press Enter to complete, and press F3 to save and exit.

3.2.4 Working with the print definition

This section shows an example where the appearance of the spooled file data is modified, and some new elements are added. The following steps are described in this section:

- Work with Copies
- Define the Copy

Follow these steps:

1. On the Work with Print Definitions display, type 12 next to your Print Definition. The display shown in Figure 61 appears.

```
Work with Copies

Print Definition . . . : ENHANCE          Page Format . . . . . : *DEFAULT
Library . . . . . : APUDEF

Type options, press Enter.
 1=Create  2=Change  3=Copy  4=Delete  7=Rename
10=Define

Opt Name      Text
10 *ORIGINAL  Original (first copy)

F3=Exit  F5=Refresh  F12=Cancel
```

Figure 61. Work with Copies

APU provides the *ORIGINAL copy. In the following section, you can modify the presentation of the data in this *ORIGINAL copy. You can then select option **3** if you want to duplicate the data (create a second copy), followed by option **10** to modify the data appearance of the second copy. Typically you might create the original copy to your exact requirements, and then make a copy of the Copy. Change some characteristic slightly (for example, have a different input drawer selected) so the second copy is printed on a different paper type (punched hole or colored paper, for example).

Do not make a copy of a Copy until you are completely satisfied with the appearance of your *ORIGINAL copy. Otherwise, you may make the same changes multiple times.

2. After you select option 10, several functions are available. Select the functions shown in Figure 62 on page 76.

```

                                Define a Copy
Print Definition . . . : ENHANCE           Page Format . . . . . : *DEFAULT
Library . . . . . : APUDEF             Copy . . . . . : *ORIGINAL

Type options, press Enter.
1=Select

Opt  Function

      Select a sample spooled file
1   Set page layout options
1   Define field mapping
      Define constants
      Define boxes
      Define page segments
1   Define overlays

      F3=Exit  F12=Cancel

```

Figure 62. Define a Copy

Note: Only some APU options are described here. More information about functions, such as data mapping and conditional processing, are available in the *AS/400 APU User's Guide*, S544-5351, or in *AS/400 Guide to AFP and PSF*, S544-5319.

APU can also add such elements as boxes, lines, constant text and barcodes, page segments, and overlays. Only the options in bold are partially described in the following section.

The following sections show the displays for all selected options, and do not show the Define a Copy display after each step.

3. Press Enter, and the first selected option display is shown. APU permits a different format for each copy. Change the drawer parameter on the Set Page Layout Options display to select another paper source for one of your copies (see Figure 63).

```

                                Set Page Layout Options
Print Definition . . . . ENHANCE          Page Format . . . . . : *DEFAULT
  Library . . . . .      APUDEF          Copy . . . . .       : *ORIGINAL

Type choices, press Enter.

Input drawer . . . . . 2                *DEFAULT, 1, 2, 3, 4

Default line increment  *PRIDEF *CM          *PRIDEF, *INPUT, Value
Default Column inc. . . *PRIDEF *CM          *PRIDEF, *INPUT, Value
Page length . . . . .  *PRIDEF *CM          *PRIDEF, *INPUT, Value
Page width . . . . .   *PRIDEF *CM          *PRIDEF, *INPUT, Value
Top margin (down) . . . *PRIDEF *CM          *PRIDEF, 0, Value
Left margin (across) . . *PRIDEF *CM          *PRIDEF, 0, Value
Page orientation . . . . *PRIDEF          *PRIDEF, *INPUT, 0, 90...
Duplex printing . . . . . 1=Yes, 2=Tumble
Back overlay . . . . .  *NONE              *NONE, Name   F4 for list
  Position across . . . . *CM              0, Value
  Position down . . . . . *CM              0, Value

F3=Exit  F4=Prompt  F12=Cancel  F22=Set Units

```

Figure 63. Set Page Layout Options

- After you press Enter, the next option is shown. The Define Field Mapping display (Figure 64) shows the content of our SCS spooled file. APU maintains the correct line spacing of the spooled file.

```

                                Define Field Mapping
Spooled file . . . . . : ENHANCE          Page/Line . . . . . : 1/1
Control . . . . .      Columns . . . . . : 1 - 78
*...+...1...+...2...+...3...+...4...+...5...+...6...+...7...+...

Cedric & Marc Ltd,
64 Dream Avenue
Doerfli CO 80301

Phone 012 008 1988
Fax 006 001 1992

INVOICE NR. 123456

Customer Nr. 778899

Kaffee H. Goodlooks
No return Avenue 12
More...

F3=Exit      F11=Hide mapping  F12=Cancel      F13=27x132 Mode
F14=Start field  F15=End field    F16=Delete range  F24=More keys

```

Figure 64. Define Field Mapping

- In this example, we change the font of the INVOICE NR. field. Place the cursor on the I of INVOICE, and press PF14. The rest of the line appears in reverse

video. Move the cursor to the place where your invoice number stops and press PF15.

6. Select the function to **Map as Text** in the pop-up window (not shown). The Map Text display appears as shown in Figure 65.

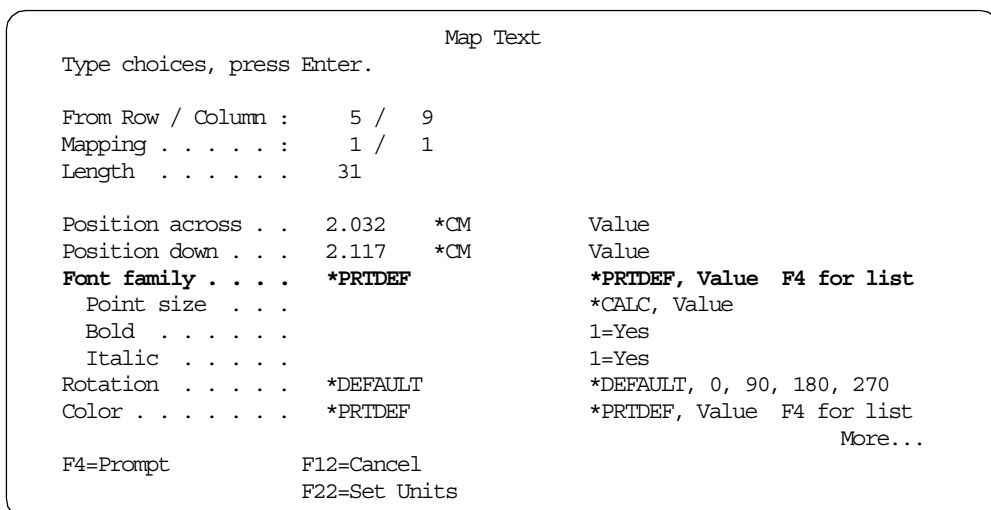

Figure 65. Map Text

7. Move your cursor to the Font family field, and press the PF4 key. Select a font from the list (Helvetica 14 point was used for this example). Press Enter to return to the Define Field Mapping display.

You do not need to define field mappings for the complete page. APU will print all the remaining data according to the default values in the Print Definition Attributes.

You can add fixed elements such as lines, boxes (no shading), constant text, and barcodes in APU. *No additional software is required.*

Page segments and overlays must be created with an appropriate tool, such as the AFP driver, or by using AFP Utilities/400. See Chapter 2, “Advanced Function Presentation” on page 35, for information on using these resources and Chapter 5, “The IBM AFP Printer Driver” on page 117, to create an overlay with the AFP driver.

8. You can place overlays using the display shown in Figure 66.

```

                                Define Overlay Positioning

Print Definition . . . : ENHANCE          Page Format . . . . . : *DEFAULT
  Library . . . . . :   APUDEF          Copy . . . . . : *ORIGINAL

Type options, press Enter.
  1=Create  2=Change  3=Copy  4=Delete

      Position  Position  Unit of
Opt across   down     measure  Overlay

  1

      (There are no overlay positioning defined)

F3=Exit  F5=Refresh  F12=Cancel

```

Figure 66. Define Overlay Positioning: Initial display

9. Select **1**, and enter the overlay name. Press F4 as a prompt, if required.
10. Press PF12 to complete your Print Definition, and type **1** to save it on the confirmation display.

3.2.5 Testing the print definition

To test the print definition, follow this process:

1. To test the new Print definition with our spooled file *interactively*, go to the APU main menu, and select option **2** (Work with Spooled Files).
2. A list of SCS spooled files is displayed. Select an appropriate spooled file (one with data in the same layout as your sample spooled file) by typing **1** next to it. You can change the output queue and the user to narrow the search if necessary. The display is shown in Figure 67.

```

                                Apply Print Definition (APYPRTDEF)

Type choices, press Enter.

Input Spooled File . . . . . > ENHANCE      Name
Job name . . . . . > PRT_ORDER      Name, *
  User . . . . . > CEDRIC          Name
  Number . . . . . > 023810       000000-999999
Spooled file number . . . . . > 3     1-9999, *ONLY, *LAST
Print Definition . . . . . *SPOOLFILE  Name, *NONE, *SPOOLFILE
  Library Name . . . . . *PRIDEFLIB  Name, *PRIDEFLIB, *LIBL
Run option . . . . . *NORMAL      *NORMAL, *NOCOPY, *REPRINT

Post processing SUCCESS:
  Input Spooled File . . . . . *HOLD    *HOLD, *NONE, *DELETE, *OUTQ
  Output queue . . . . .           Name
  Library Name . . . . .           Name, *LIBL

Post processing FAILURE:
  Input Spooled File . . . . . *HOLD    *HOLD, *NONE, *DELETE, *OUTQ
  Output queue . . . . .           Name
  Library Name . . . . .           Name, *LIBL

F3=Exit  F4=Prompt  F5=Refresh  F12=Cancel  F13=How to use this display .
F24=More keys

```

Figure 67. Apply Print Definition (APYPRTDEF)

3. Type the print definition name, and press Enter. The new AFP spooled file is created and the SCS spooled file is held on the output queue with a status of HLD. The creation of the AFP spooled file is indicated by a series of lines and asterisks at the bottom of the display (moving from left to right). The particular phases are described in 2.4.5, "Print engine" on page 66.

3.2.6 Printing using the APU monitor

Once you test your APU print definitions interactively, you may want to use them in batch mode for production printing. The APU monitor is a facility included with APU that can monitor output queues, apply print definitions, and send the resulting AFP spooled files to other output queues, all without intervention.

It is an extremely powerful part of APU, and its capabilities are extensive. Two versions of the APU monitor are available. The latest monitor is set up using option 8 on the main APU menu.

3.2.6.1 Printing using the first version of the monitor

Follow these steps:

1. Type 3 on the APU menu and add the output queue to be monitored. Use an output queue without a printer writer started to it if possible.
2. Type 4 on the APU menu to start the monitor.
3. The print definition name must match the spooled file name.
4. The spooled file must be in RDY status.
5. The spooled file must be of type *SCS.

3.2.6.2 Printing with the new version of the monitor

The new monitor can be used in a similar manner. You only have to create an Action entry with default attributes using option 8 from the APU main menu. You do not need to define or change the three functions shown in Figure 68.

The default values are defined to be compatible with the first monitor version. For more information about the new monitor capabilities, see Chapter 2, "Advanced Function Presentation" on page 35.

To create an Action entry for the APU monitor, use option 8 on the APU main menu. The display is shown in Figure 68.

```

                                Create action entry

Type choices, press Enter.

Sequence . . . . . 10                Number
Text . . . . . Use default parameter

Type options, press Enter.
  1=Select

Opt  Function

      Define selection for input spooled file
      Define action for input spooled file
      Define action for output spooled file

F12=Cancel

```

Figure 68. APU with monitor

After your action entry is created, you need to add the output queue and start the monitor as already described for the first monitor. As soon as a spooled file with the same name as your print definition arrives on the monitored queue, the APU spooled file is automatically produced.

3.3 Using the Page Printer Formatting Aid

Page Printer Formatting Aid (PPFA) is a compiler for standard AFP print formatting resources called *page definitions* and *form definitions*. It compiles the source modules for these resources into AS/400 objects. AFP page and form definitions are source and object level compatible, so these modules can be interchanged between AFP systems and applications.

Note: Do not confuse an APU print definition with the two AFP resources mentioned here. Page and form definitions are commonly referred to as “pagedefs” and “formdefs”.

Table 4. Components required for this example

Components	IPDS printer
1 PPFA	YES
2 PSF/400	YES
3 Font Collection	Recommended
4 AFP Utilities/400	Optional
5 AFP Printer Driver	Optional

Notes

- 1** PPFA is a part of the AFP PrintSuite/400 and does not require any additional components to create page and form definitions. The PPFA resources are usable on most other AFP systems with a Print Services Facility (PSF) installed. PSF/2 does not support Page Definitions.
- 2** PSF/400 is required to print with PPFA resources. The IPDS printer must be configured with AFP=*YES. See 3.3.4, “Considerations” on page 88, for more information about the restrictions of spooled files processed with PPFA resources.
- 3** PPFA uses downloaded fonts in AFP Raster or Outline format. The QFNTCPL library is delivered with OS/400 but contains fonts in 240-pel resolution. If the printer uses 300-pel resolution, font substitution occurs and the presentation of the data may not be as desired. See 4.6, “Font substitution” on page 101, for more information about font substitution.
- 4** AFP Utilities/400 can be used to create overlays that are referenced by PPFA.
- 5** The AFP Printer Driver can also be used to create overlays. For more information about the AFP driver, see Chapter 5, “The IBM AFP Printer Driver” on page 117.

3.3.1 Creating a source physical file for form and page definitions

You must first create a source physical file to contain the source code:

1. Create a source physical file to contain the code:

```
CRTSRCPF FILE(MYLIB/PPFASRC1) MBR(ENHANCE)
```

2. Invoke the Source Entry Utility (SEU) to edit the new member (you can also use WRKMBRPDM or other commands, according to your preferences):

```
STRSEU SRCFILE(MYLIB/PPFASRC1) SRCMBR(ENHANCE)
```

3. Code the form definition and page definition as shown here:

```
0001.00 /*-----*/
0002.00 /* ENHANCE OUR OUTPUT WITH */
0003.00 /* PAGE PRINTER FORMATTING AID */
0010.00 /*-----*/
0011.00 FORMDEF FORMJH 1
0012.00 REPLACE YES ;
0013.00
0014.00
0015.00 COPYGROUP FORM1 ; 2
0016.00 SUBGROUP COPIES 1 OVERLAY SMPOVL1
0017.00 SUBGROUP COPIES 1 OVERLAY SMPOVL2
0012.00
0013.00
0014.00 3
0015.00 SETUNITS 1 INCH 1 INCH
0016.00
0017.00
0018.00
0019.00
0020.00
```

Notes

- 1** FORMJH is the name of the form definition. REPLACE *YES is used to tell PPFA to replace the form definition if it already exists.
- 2** We use the Copy Group statement to provide two copies. Note that each copy has a different overlay.
- 3** We set the general parameter using the SETUNITS command.

In the same source file, we can code the page definition source shown in the following examples:

```
0021.00
0022.00 PAGEDEF PAGEJH
0023.00     WIDTH  8.0 IN      1
0024.00     HEIGHT 11.0 IN
0025.00     DIRECTION ACROSS 2
0026.00     REPLACE YES;
0027.00     FONT NORM CR12;   3
0028.00     FONT BIG H200D0;
0029.00
```

Notes

- 1** You must define the paper size in inches, millimeters, or units.
- 2** This specifies portrait orientation.
- 3** Define the font using a coded font name. "CR12" is used for most of the data. "H200D0" is used for the "INVOICE NR" in our invoice example.

```
0030.00 PRINTLINE
0031.00
0032.00     POSITION 0.8 IN 0.166 1
0033.00     FONT NORM 2
0034.00     REPEAT 7 3
0035.00
```

Notes

- 1** After the first input line is recognized, provide the information where the data will start to print. Inches or millimeters can be used.
- 2** Define the font to be used for the data using the coded font name.
- 3** The same formatting is used for the next seven lines of your data.

```
0036.00 PRINTLINE 1
0038.00     POSITION 0.8 IN 1.5 2
0039.00     FONT BIG 3
0041.00
```

Notes

- 1 This keyword is used to define the next print line after the repetition. You must define the entire page of your existing data in the spooled file.
- 2 Define the position for INVOICENR. No keyword REPEAT is required if only one line or line portion is defined.
- 3 Now you can use the Helvetica 14 point (pt) font defined on line 0028.00.

```
0042.00 PRINTLINE
0044.00 POSITION 0.8 IN 1.666 1
0045.00 FONT NORM 2
0046.00 REPEAT 38 3
```

Note:

- 1 Define the next print position of the data.
- 2 Use the font NORM for the rest of the data.
- 3 REPEAT 38 indicates that the next 38 lines have the same formatting.

This is a simple example of using page and form definitions for document formatting. The intent is to illustrate the concept, not to define the capabilities. These AFP resources are capable of producing sophisticated document output, including program logic based on the line data field content.

3.3.2 Compiling the form and page definitions

Before you can use the page and form definition, you must create the AFP resource by compiling the source code. The following commands are used for this purpose:

CVTPPFASRC Create a page definition and form definition.
CRTFORMDF Create a form definition object.
CTRPAGDFN Create a page definition object.

3.3.2.1 Creating the AFP resources

You must create a physical file in which to place the compiled objects. In the following example, we use:

- A physical file FORMDEF to receive the AFP form definition as a member.
- A physical file PAGEDEF to receive the AFP page definition as a member.

Add the QPPFA library in your library list. Otherwise, you cannot find the CVTPPFASRC command. Type `CVTPPFASRC` on the command line, and press PF4 (Prompt) to see the display like the example shown in Figure 69.

```

Convert PPFA Source (CVTPPFASRC)

Type choices, press Enter.

File . . . . . > PPFASRC1      Name
  Library . . . . . > MYLIB      Name, *LIBL, *CURLIB
Member . . . . . > ENHANCE      Name
Form definition file . . . . . > FORMDEF      Name, *NONE
  Library . . . . . > MYLIB      Name, *LIBL, *CURLIB
Page definition file . . . . . > PAGEDEF      Name, *NONE
  Library . . . . . > MYLIB      Name, *LIBL, *CURLIB
Listing output . . . . . > *NONE      *PRINT, *NONE
Source listing options . . . . .      *SRC, *NOSRC, *SECLVL...

Bottom

F3=Exit  F4=Prompt  F5=Refresh  F12=Cancel  F13=How to use this display
F24=More keys

```

Figure 69. Creating the AFP resources

Note

You can create one or both objects at the same time. This example shows that both objects are compiled and placed in two different physical files. The member resulting from the compilation has the name defined in the source code (FORMJH for the form definition and PAGEJH for the page definition). A prefix is added at the front of the name depending on the type of object, F1 and P1.

3.3.2.2 Creating the form and page definition objects

You need to invoke the CRTFORMDF command to create the AS/400 form definition. Type CRTFORMDF on the command line, and press PF4 to see a display like the example shown in Figure 70.

```

Create Form Definition (CRTFORMDF)

Type choices, press Enter.

Form definition . . . . . > F1FORMJH      Name
  Library . . . . . > MYLIB      Name, *CURLIB
File . . . . . > FORMDEF      Name
  Library . . . . . > MYLIB      Name, *LIBL, *CURLIB
Member . . . . . > *FORMDF      Name, *FORMDF
Text 'description' . . . . . > 'New form definition sample'

Bottom

F3=Exit  F4=Prompt  F5=Refresh  F10=Additional parameters  F12=Cancel
F13=How to use this display  F24=More keys

```

Figure 70. Creating the AS/400 *FORMDF object

Notice we add the F1 prefix to the name of the form definition so it picks up the correct member name. To create the page definition, type CRTPAGDFN on the command line and press PF4 to see a display like the example shown in Figure 71.

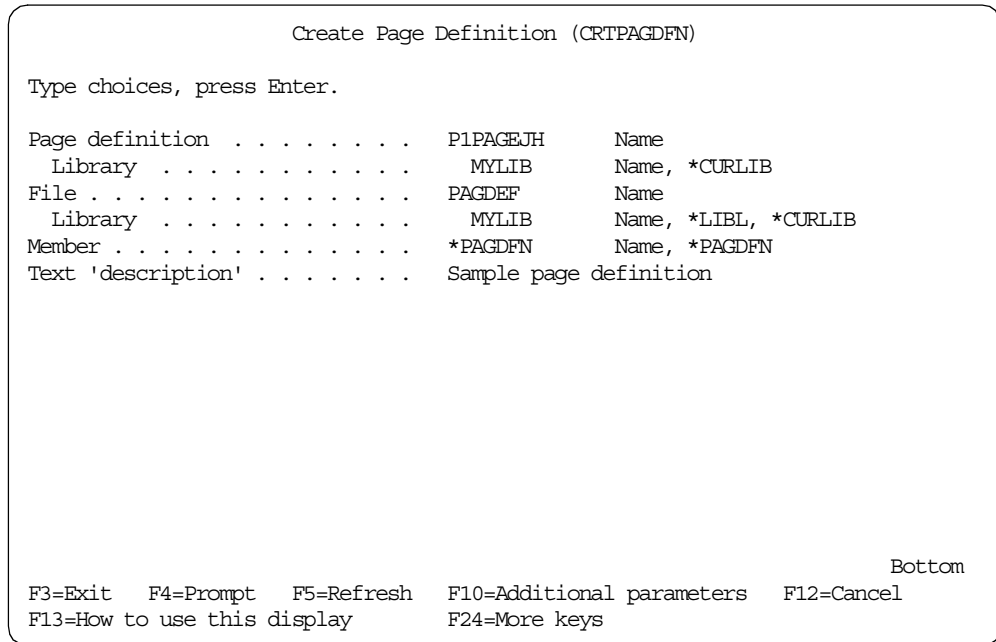

Figure 71. Creating the AS/400 *PAGDFN object

3.3.3 Printing with the form and page definitions

You can only use page and form definitions with LINE data or AFPDS. Line data is similar to SCS data but does not contain any SCS formatting information. You must change or override your application printer file to specify DEVTYPE=*LINE and add the form definition and page definition names.

Note: DEVTYPE=*LINE is not supported for externally described printer files (DDS support).

Figure 72 shows you how to change the device type in the printer file.

```

Change Printer File (CHGPRTF)

Type choices, press Enter.

File . . . . . > ENHANCE      Name, generic*, *ALL
  Library . . . . .          *LIBL      Name, *LIBL, *ALL, *ALLUSR...
Device:
  Printer . . . . .          *SAME      Name, *SAME, *JOB, *SYSVAL
Printer device type . . . . . > *LINE    *SAME, *SCS, *IPDS, *LINE...
Page size:
  Length--lines per page . . . . *SAME      .001-255.000, *SAME
  Width--positions per line . . *SAME      .001-378.000, *SAME
  Measurement method . . . . . *SAME      *SAME, *ROWCOL, *UCM
  Lines per inch . . . . .      *SAME      *SAME, 6, 3, 4, 7.5, 7,5...
  Characters per inch . . . . . *SAME      *SAME, 10, 5, 12, 13.3, 13...
  Overflow line number . . . . . *SAME      1-255, *SAME
  Record format level check . . . *SAME      *SAME, *YES, *NO
  Text 'description' . . . . . *SAME

More...

F3=Exit  F4=Prompt  F5=Refresh  F12=Cancel  F13=How to use this display
F24=More keys

```

Figure 72. Change Printer File (CHGPRTF) (Part 1 of 2)

Press the Page Down or Page Forward key to move to the next display, shown in Figure 73.

```

Change Printer File (CHGPRTF)

Type choices, press Enter.

Decimal format . . . . .      *SAME      *SAME, *FILE, *JOB
Font character set:
  Character set . . . . .      *SAME      Name, *SAME, *FONT
  Library . . . . .           *LIBL      Name, *LIBL, *CURLIB
  Code page . . . . .         Name
  Library . . . . .           *LIBL, *CURLIB
  Point size . . . . .        000.1-999.9, *NONE
Coded font:
  Coded font . . . . .        *SAME      Name, *SAME, *FNTCHRSET
  Library . . . . .           *LIBL, *CURLIB
  Point size . . . . .        000.1-999.9, *NONE
Table Reference Characters . . . *SAME      *SAME, *YES, *NO
Page definition . . . . .      P1PAGEJH    Name, *SAME, *NONE
  Library . . . . .           MYLIB      Name, *LIBL, *CURLIB
Form definition . . . . .      F1FORMJH    Name, *SAME, *NONE, *DEVD
  Library . . . . .           MYLIB      Name, *LIBL, *CURLIB

More...

F3=Exit  F4=Prompt  F5=Refresh  F12=Cancel  F13=How to use this display
F24=More keys

```

Figure 73. Change Printer File (CHGPRTF) (Part 2 of 2)

Complete your printer file modification by pressing Enter. Now you can invoke your print program. A spooled file is placed in the output queue. Because the spooled file contains only line data, you cannot display or send this spooled file.

3.3.4 Considerations

Creating and using page and form definitions provides powerful formatting capabilities. However, you need to consider some characteristics of this approach to formatting:

- Once a page or form definition is created, the run-time support is provided by PSF/400. The compiler (PPFA) is only required on the development system.
- The example in this chapter uses only a few of the capabilities of PPFA. Creating more complex applications requires greater AFP skills.
- Several Business Partner products are available to design page and form definitions (see 2.2.2, “OEM products” on page 45). These products provide a graphical design interface for these resources (there is no graphical interface available on the AS/400 system).
- Using LINE data with page and form definitions for formatting has the following restrictions:
 - You cannot copy, display, or send a spooled file produced with LINE data.
 - You cannot use the AFP Viewer (see 5.6.3.1, “Using the AFP Viewer” on page 132) to display the spooled file.
 - Spooled files formatted with page and form definitions cannot be converted to an ASCII printer data stream by the host print transform.

3.4 APU versus PPFA

Table 5 shows a comparison between APU and PPFA.

Table 5. APU and PPFA comparison

Function	APU	PPFA
Display the input spooled file	YES	NO
Can draw line and box without overlay	YES	NO
Can place overlays and page segments	YES	YES
Display spooled file output on a terminal	YES	NO
Support Outline Font (download)	YES	YES
Font Character Set and Code Page support	YES	NO
Coded font	NO	YES
Program must be installed on each system	YES	NO
Display SPLF with AFP viewer	YES	NO
Print spooled file with host print transform	YES	NO
Requires PSF/400	Only for IPDS printers	YES
Spooled file can be sent using SNDNETSPLF	YES	NO
DBCS enabled	NO	YES

Chapter 4. Fonts

This chapter describes how fonts are specified in AFP applications and the new font enhancements for OS/400 at Version 3 Release 2 and higher. For an introduction to AS/400 font terminology, refer to Appendix D of *AS/400 Printer Device Programming* or Chapter 6 of *AS/400 Guide to AFP and PSF*, S544-5319.

4.1 Where fonts are stored

Fonts are stored either in the printer (*printer-resident*) or on the AS/400 system (*host-resident*). In the latter case, they are automatically downloaded to the printer by PSF/400 when required.

4.1.1 Printer-resident fonts

These fonts are usually held in the printer's non-volatile memory (NVRAM) or on a hard disk, but older printers may keep them on diskette, font cards, cartridges, or even daisy wheels.

Printer-resident fonts are selected by a Font Global Identifier (FGID). For example, one version of Courier may be 011, while a version of Times New Roman is 5687.

Listing printer-resident fonts is usually done by selecting a test option from the printer menus or referring to the printer operating guide. Be sure that you are viewing the font list for the appropriate data stream (for example, IPDS fonts are not available to PC applications). Similarly, AFP applications cannot make direct use of PCL or PostScript fonts. Ensure that you select the decimal value of the FGID, not the hex value that may also be listed. A page from the IPDS font list from an IBM Network Printer 17 is shown in Figure 74 on page 90.

IBM Network Printer 17

IPDS Compatibility Fonts

FONT STYLE	POINT		POINT WIDTH	PPI	DOT SIZE	SAMPLE
	Hex.	Decl.				
APL	004C	76	120	12		ABCDEFGHIJ 0123456789
Boldface	009F	159	120	PS		ABCDEFGHIJ abcdefghij 0123456789
Courier	000B	11	144	10		ABCDEFGHIJ abcdefghij 0123456789
Courier	0055	85	120	12		ABCDEFGHIJ abcdefghij 0123456789
Courier	00DF	223	96	15		ABCDEFGHIJ abcdefghij 0123456789
Courier	00FE	254	84	17.1		ABCDEFGHIJ abcdefghij 0123456789
Courier Bold	002E	46	144	10		ABCDEFGHIJ abcdefghij 0123456789
Courier Italic	0012	18	144	10		ABCDEFGHIJ abcdefghij 0123456789
Courier Italic	005C	92	120	12		ABCDEFGHIJ abcdefghij 0123456789
Gothic Text	00CB	203	108	13.3		ABCDEFGHIJ abcdefghij 0123456789
Gothic Text	011B	283	72	20		ABCDEFGHIJ abcdefghij 0123456789
Gothic Text	0122	290	54	26.7		ABCDEFGHIJ abcdefghij 0123456789
Letter Gothic	0119	281	72	20		ABCDEFGHIJ abcdefghij 0123456789
OCR A	0013	19	144	10		ABCDEFGHIJ abcdefghij 0123456789
OCR B	0003	03	144	10		ABCDEFGHIJ abcdefghij 0123456789
Prestige Pica	000C	12	144	10		ABCDEFGHIJ abcdefghij 0123456789
Prestige Elite	0056	86	120	12		ABCDEFGHIJ abcdefghij 0123456789
Prestige	00DD	221	96	15		ABCDEFGHIJ abcdefghij 0123456789
Prestige	0100	256	84	17.1		ABCDEFGHIJ abcdefghij 0123456789
Prestige Elite Bold	006F	111	120	12		ABCDEFGHIJ abcdefghij 0123456789
Prestige Elite Italic	0070	112	120	12		ABCDEFGHIJ abcdefghij 0123456789
Times New Roman (TNR)	1637	5687	40	TYPO	6	ABCDEFGHIJ abcdefghij 0123456789
Times New Roman	1637	5687	53	TYPO	8	ABCDEFGHIJ abcdefghij 0123456789
Times New Roman	1637	5687	67	TYPO	10	ABCDEFGHIJ abcdefghij 0123456789
Times New Roman	1637	5687	80	TYPO	12	ABCDEFGHIJ abcdefghij 0123456789

Figure 74. IPDS font listing from an IBM Network Printer 17

In terms of performance, printer-resident fonts are the preferred option. Some printers, such as the IBM Advanced Function Common Control Unit (AFCCU) printers and the IBM Network Printer range, have scalable resident fonts, which means that large (or small) characters can be printed without loss of shape or clarity. The scaling process is carried out by the printer, avoiding any host processing overhead.

The downside is that different printers may give different results printing the same data due to the printers' different font capabilities. OS/400 usually invokes font substitution to ensure that something is printed, but it may not be what you were expecting! An even worse situation is when a substituted font becomes the corporate standard. A new printer may subsequently print the correct font but appear to the customer to be printing the "wrong" font.

4.1.2 Host-resident fonts

Host-resident fonts are stored in AS/400 system libraries shipped with the operating system. For example, QFNTCPL is a library of 240-pel IBM Compatibility fonts. There is a range of chargeable fonts available in both 240- and 300-pel density. Providing no font substitution takes place (and this can be controlled), the fidelity of the typeface and positioning of characters is guaranteed from printer to printer. The character sets and code pages are classified

according to their characteristics so that you can soon learn to change to a different font simply by altering a single letter in the character set name, for example:

C0H20080	Helvetica Latin1-Roman Medium 8-point
C0H20090	Helvetica Latin1-Roman Medium 9-point
C0H30090	Helvetica Latin1-Italic Medium 9-point
C0H50090	Helvetica Latin1-Italic Bold 9-point

Holding font resources centrally is desirable from a change management and security point of view. However, these fonts must be downloaded at the beginning of a job. This may have implications on performance; there may be a delay before the first page of the job is printed. The font resources usually remain resident in the printer for subsequent jobs and eliminate this problem. Other considerations are that host-resident raster fonts take up large amounts of disk space. Take care to include them in the users' library list (for interactive jobs) or the job's own library list (for batch jobs). Techniques you can use to minimize these issues are described in 4.5.1, "Downloading host-resident outline fonts" on page 100, and in 4.9, "Using a resource library list" on page 107.

Host-resident fonts are selected by specifying a font character set and code page (FNTCHRSET and CDEPAG), for example:

C0S0CR10	Courier Roman 10-point
T1V10285	United Kingdom

They may also be selected by using a coded font (CDEFNT), which is a specific combination of character sets and code pages, for example:

X0CR07	Courier Roman 10-point (UK)
---------------	-----------------------------

X0CR07 is a reference to the same character set and code page combination previously shown. Most IBM font products are placed in libraries beginning with "QFNTxxx", so use the following command to quickly locate them and to look for all font resources on your system:

```
WRKLIB *ALL/QFNT*  
WRKOBJ OBJ(*ALL/*ALL) OBJTYPE(*FNTRSC)
```

When you have located the font resources, you can use the Work with Font Resources (WRKFNTRSC) command. For example, the following command locates all font character set names in the QFNTCPL library:

```
WRKFNTRSC FNTRSC(QFNTCPL/*ALL) OBJATR(FNTCHRSET)
```

The pel density can also be determined by selecting option 5 (Display attributes).

4.2 How fonts are selected

Fonts can be selected for an entire spooled file or for individual lines or fields within a spooled file. The usual place to specify the font for an entire spooled file is in the printer file. This is achieved by using the CRTPRTF, CHGPRTF, or OVRPRTF command. The relevant keywords for these commands are:

- **FONT**

Font Global Identifier (FGID). The point size (if more than one point size is available) may also be specified.

- **FNTCHRSET**

Font Character Set. This can only be specified when the printer file also has DEVTYPE(*AFPDS), and is used only when printing to IPDS printers configured with AFP=*YES. A code page must also be specified.

- **CDEFNT**

Coded Font. This can only be specified when the printer file also has DEVTYPE(*AFPDS) and is used only when printing to IPDS printers configured with AFP=*YES.

Varying font selection by field for line is normally done within an externally-described printer file using Data Description Specifications (DDS). The parameters previously listed are also available as DDS keywords. Unlike a standard printer file, multiple fonts may be specified together with functions such as BARCODE to print characters as a barcode and CHRSIZ to scale characters (although using an outline font and varying point size is a superior method; see 4.5.2, “Why use an outline font” on page 100).

The data stream that OS/400 produces when converting and printing a spooled file is determined by the DEVTYPE parameter in the printer file. This also has an effect on font selection as shown in Table 6.

Table 6. Font and data stream support

DEVTYPE parameter	Font ID	Font character set	Coded font
*SCS	Yes	No	No
*IPDS	Yes	No	No
*AFPDS	Yes	Yes ¹	Yes ¹
*LINE	Yes	Yes ^{1 2}	Yes ^{1 2}
1. Printer must be configured as *IPDS, AFP=*YES. 2. When used in a page definition applied to the line data.			

Note that externally-described printer files (created using DDS) may have multiple fonts selected for different records to be printed. A printer file created with device type *SCS is restricted to the selected font for the entire spooled file.

Table 6 does not include device types *USERASCII or *AFPDSLIN. The application is entirely responsible for creating the data stream in the former case. *USERASCII simply tells OS/400 to send the data to the printer “as is”. There might well be ASCII transparency commands to change fonts within the data. For AFPDSLIN, fonts are normally selected in a page definition associated with the line data.

4.2.1 Characters per inch (CPI)

The CPI parameter may be specified when the FGID is not known, or where use of a particular fixed-pitch is more important than a font type style. This is usually used for SCS printers.

For IPDS printers (and most SCS printers), the selected font has an implied CPI value. For monospaced fonts, you can rely on a fixed pitch for your font. For proportionally-spaced and typographic fonts, the characters per inch varies

depending on the characters in your data. However, if FONT(*CPI) is specified, a particular monospaced font is used as shown in Table 7. If these default fonts are not available, a printer-resident font is substituted (see 4.6, “Font substitution” on page 101).

Table 7. CPI to font relationship

CPI	Default font ID	Name
5	245	Courier Bold Double Wide
10	011	Courier
12	087	Letter Gothic
13.3 *	204	Matrix Gothic
15	222	Gothic
16.7	400	Gothic
18 ¹	252	Courier
20 ¹	281	Gothic Text
* These values are valid only for DBCS printers		

System-supplied printer files use FONT(*CPI). This ensures that the appearance of the output is similar regardless of the printer that is used.

When you specify PAGRTT(*COR) on the printer file, the following font substitution occurs:

- 12-pitch fonts are replaced with 15-pitch fonts (FGID 222).
- 15-pitch fonts are replaced with 20-pitch fonts (FGID 281).
- All other fonts are replaced with a 13.3 pitch font (FGID 204) with the exception of the 4028 printer, which uses a 15-pitch font (FGID 222).

Vertical spacing (specified by the LPI parameter) is 70 percent of the normal spacing.

4.3 Which fonts are available

Be aware that there are no 300-pel fonts supplied as a default with OS/400. Therefore, it is usually necessary to buy some font libraries unless you rely on using printer-resident fonts only.

Purchased font libraries are usually restored to a QFNTxx library name using the Restore Licensed Program (RSTLICPGM) command.

4.3.1 Fonts supplied at no charge

There are two types of fonts that are supplied at no charge. These fonts are:

- **AFP compatibility fonts:** The QFNTCPL library is installed with OS/400. Therefore, the product number is the same as the operating system. The library contains the 240-pel compatibility fonts, for example Courier, Gothic, Orator, Prestige, and Proprinter Emulation. These fonts were available on older IBM printing devices, therefore the term “compatibility”, and are required for Facsimile Support/400 (Fax/400). Fax/400 emulates an IPDS printer and

uses only 240-pel fonts. They are mostly fixed-pitch fonts measured in characters per inch (5, 8.55, 10, 12, 13.3, 15, 17.1, 18, 20, 27 cpi), but a few are mixed-pitch characters that are approximately 12 cpi.

- **300-pel euro symbol support:** Support for the euro currency symbol was added at V4R3 for both 240-pel and 300-pel printer resolutions.

4.3.2 240-pel fonts available at a charge

The following fonts are available, but for a charge:

- **5763-FNT Advanced Function Printing Fonts/400:** This product has been largely superseded by the IBM AFP Font Collection (see Table 8) but may still be a requirement if you specifically need one or more of the Sonoran font families. For new customers, purchasing the AFP Font Collection is a much better value and a preferred strategy for the reasons explained in 4.5.2, “Why use an outline font” on page 100.

Table 8. 5763-FNT Advanced Function Printing Fonts/400

Library	Feature code	Family
QFNT01	5051	Sonoran Serif
QFNT02	5052	Sonoran Serif Headliner
QFNT03	5053	Sonoran Sans Serif
QFNT04	5054	Sonoran Sans Serif Headliner
QFNT05	5055	Sonoran Sans Serif Condensed
QFNT06	5056	Sonoran Sans Serif Expanded
QFNT07	5057	Monotype Garamond
QFNT08	5058	Century Schoolbook
QFNT09	5059	Pi and Specials
QFNT10	5060	ITC Souvenir
QFNT11	5061	ITC Avant Garde Gothic
QFNT12	5062	Math and Science
QFNT13	5063	DATA1
QFNT14	5064	APL2
QFNT15	5065	OCR A and OCR B

You may also notice QFNT00, which does not contain any fonts, but contains product control information such as the message file, copyright notices, and modification level.

- **5763-FN1 Advanced Function Printing DBCS Fonts/400:** These fonts are downloadable double-byte character set raster fonts. See Table 9 for an overview of these fonts.

Table 9. 5730-FNI Advanced Function Printing DBCS fonts/400

Library	Feature code	Family
QFNT61	5071	Japanese
QFNT62	5072	Korean
QFNT63	5073	Traditional Chinese
QFNT64	5074	Simplified Chinese
QFNT65	5075	Thai

- **5648-B45 AFP Font collection version 2:** This is the latest version of the IBM AFP Font Collection. This includes a comprehensive set of 240-pel and 300-pel fonts, and outline font character sets and coded fonts. Support for the euro currency symbol and new languages (Thai and Lao) is also included.

4.3.3 300-pel fonts available at a charge

IBM AFP Font Collection (5648-B45) is the standard font set for the AS/400 system. This is also the consolidated AFP font product, available across all of the major IBM system platforms. IBM AFP Font Collection consists of the Expanded Core fonts and the Compatibility fonts. The Expanded Core Fonts include such standard font families as Helvetica, Times New Roman, and Courier. These fonts are provided in the 240-pel, 300-pel, and outline format. The fonts come in over 48 language groups.

Notes

- At OS/400 V4R5, the IBM AFP Font Collection CD is shipped with new orders of Print Services Facility/400 (PSF/400).
- There are several older font families, such as Sonoran, that are not part of the IBM AFP Font Collection. These are available in the 300-pel format via Programming Request for Price Quotation (PRPQ).

An optional feature of IBM AFP Font Collection is Type Transformer and Utilities for Windows. This is a comprehensive “workbench” for creating and customizing fonts. The core utility provides for the conversion of any Adobe Type 1 font to an AFP font. Since TrueType fonts can be easily converted to Adobe Type 1 format, virtually any PC-based font can be converted to an AFP font. Additional utilities provide for editing individual characters within a font as well as customizing font code pages and coded fonts.

Note: Type Transformer was only available initially under OS/2. In June 2000, the Windows version became available. This version is implemented with an extensive graphical interface and interactive management of font upload operations.

More information on Type Transformer and Utilities for Windows can be found in 4.11, “Creating AFP fonts with Type Transformer” on page 110.

In addition to Type Transformer and Utilities for Windows, a number of DBCS font sets are also available as optional features of IBM AFP Font Collection.

4.4 How fonts are installed

Font libraries supplied on tape media are simply restored to the system by using the RSTLICPGM command or option 11 from the LICPGM menu (GO LICPGM). The IBM AFP Font Collection may be ordered on tape or CD-ROM media.

- **Tape media:** There are over forty libraries on tape media, but it is unlikely that all will be required. Choose the appropriate libraries for your country or language. For many customers, the most preferred ones are:

QFNTCDEPAG	Expanded code pages
QFNTCFOLA1	Latin 1 outline character sets. These are the equivalent of the IBM Core Interchange fonts, but in outline format.
QFNTCPL	240-pel Compatibility fonts. This should already be on the system. It includes some code pages.
QFNT300CPL	300-pel versions of the Compatibility fonts.
QFNT240LA1	Latin 1 character sets, 240 pel. These may be regarded as the equivalent of the IBM Core Interchange Font set.
QFNT300LA1	Latin 1 character sets, 300 pel. These may be regarded as the equivalent of the IBM Core Interchange Font set.

Raster fonts such as these take up a fairly significant amount of disk space, so only add the ones you need.

- **CD-ROM media:** If you order the AFP Font Collection on CD-ROM media (as is the case if you order the optional tools such as Type Transformer), you need to transfer the fonts to the AS/400 system in one of two ways depending on whether your system has a CD-ROM drive installed (RISC systems only). Be sure to order the AS/400 version labelled "Fonts for OS/400".

To load the fonts from the system CD-ROM drive (usually named OPT01 or similar), follow these steps:

1. Mount the CD-ROM in the drive, and make the drive ready.
2. Identify which font library you want to restore using the booklet and the Program Directory listing. For example, the 300-pel Latin 1 font character set is in CD-ROM library LA1300, and the suggested host library name is QFNT300LA1.
3. Restore your selected library using the following command (or a similar one):

```
RSTLIB SAVLIB(LA1300) DEV(OPT01) OPTFILE('/LA1300') RSTLIB(QFNT300LA1)
```

Note: If you have any trouble locating file names on the CD (for example, because of missing documentation), use the GO OPTICAL menu to locate them. The Work with Optical Directories (WRKOPTDIR) is the most useful because you can determine the volume ID of the CD-ROM as well as directories and file names from this one command.

If you do not have a system CD-ROM drive, you must manually transfer the fonts as follows:

1. Refer to the booklet and the Program Directory listing to locate the CD-ROM directory containing the required fonts.

2. Upload these fonts using PC Support/400 or Client Access/400 to a suitable shared folder on the AS/400 system (for example, one called “FONTS”).

3. Create a physical data file on the AS/400 system:

```
CRTPF FILE(MYLIB/FONTPFILE) RCDLEN(8192)
      TEXT('Physical file for temporarily receiving fonts') LVLCHK(*NO)
```

4. Move each required font to the physical file:

```
CPYFRMPCD FROMFLR(FONTS) TOFILE(MYLIB/FONTPFILE) FROMDOC(COH20000)
      TRNTBL(*NONE) TRNFMT(*NOTEXT)
```

5. Create each individual font resource using the Create Font Resource (CRTFNTRSC) command as follows:

```
CRTFNTRSC FNTRSC(QFNT300LAL/COH40000) FILE(MYLIB/FONTPFILE)
      TEXT('Helvetica 10-point Bold')
```

The last two steps can be automated with CL coding. Otherwise, they must be repeated for each and every font resource.

4.4.1 Making the fonts available

Printer writer jobs need to find the requested fonts. This applies to interactive and batch jobs and for spooled files sent from other systems. The preferred way to do this is to specify the required libraries in the PSF configuration object assigned to the printer device description (see 4.9, “Using a resource library list” on page 107).

An alternative method is to add the required libraries to the system library list or the user library list. These are held as system values. You can view or change these system values using the following commands:

```
WRKSYVAL QSYSLIBL
WRKSYSVAL QUSRLIBL
```

Note

Some print enabling applications, such as AFP Utilities (5769-AF1) or Advanced Print Utility (APU, 5798-AF3), need access to those font libraries when a new overlay or APU print definition is being developed. You could add the font libraries before calling the utility menu using the EDTLIBL or ADDLIBL commands.

Another alternative method of accessing the font resources is to store them in any of the special font libraries (QFNT01 to QFNT19), assuming that they no longer exist. These are normally reserved for other chargeable font character sets, that is, AS/400 font licensed program products (see 4.3.2, “240-pel fonts available at a charge” on page 94). Since 300-pel and 600-pel printers have become the standard, there is much less likelihood that these older 240-pel fonts are needed.

These particular libraries are appended to the system portion of the user’s library list when a print job is submitted interactively. They are a useful means of ensuring that the required fonts are always available. They do not show up in a display of the user’s library list. For batch jobs, ensure that the font libraries are in the job’s library list.

There is a no-charge utility available to assist in loading your IBM AFP Font Collection (5648-B45) fonts in the special (QFNT01 to QFNT19) libraries. It can be found by clicking **Downloads** at the AS/400 printing Web site at:

<http://www.ibm.com/printers/as400>

You need to download the file from the Web to your PC and then use FTP to upload to your AS/400 system. This package includes two AS/400 commands to help you load and print sample fonts from the IBM AFP Font Collection (5648-113 or 5648-B45) software.

- LOADFNTC: Load Font Collection
- PRTFNTC: Print Font Collection Samples

Both commands provide help text describing each command's parameter.

All font objects will be restored in 10 libraries on your system as shown in Table 10.

Table 10. Restored font objects

Description	AS/400 library
AFP Font Collection Code Pages	QFNT01
AFP Font Collection Compatibility Coded Fonts	QFNT02
AFP Font Collection 240-pel Compatibility Fonts	QFNT02
AFP Font Collection 300-pel Compatibility Fonts	QFNT03
AFP Font Collection 240-pel Fonts	QFNT04
AFP Font Collection 300-pel Fonts	QFNT05
AFP Font Collection Outline Fonts	QFNT06
AFP Font Collection Coded Fonts	QFNT07
AFP Font Collection Coded Fonts (4 chars)	QFNT08
AFP Font Collection Outline Coded Fonts	QFNT09
AFP Font Collection Outline Codes Fonts (4 chars)	QFNT10

Failure to add font libraries before submitting a print job is a common problem. The symptoms are usually a PQTxxx error message in the QSYSOPR message log and a message similar to the following example:

```
Character set COA05580 could not be found or has a pel density (resolution)
incompatible with the device.
```

In this case, the message is indicating either that the character set is not present on the system, or that an object of that name exists but at the wrong pel density for the device. To correct the problem, add the library in which the object is located to the library list, or change the printer file/DDS to explicitly reference the object/library combination. The latter may be preferable for performance reasons. The operating system does not have to search through many objects in many libraries to locate the required resource.

Note: The previous example illustrates that if one has both 240- and 300-pel versions of a character set, they have the same object name and must, therefore, be stored in separate libraries. See Figure 75 for an example.

```

Work with Objects

Type options, press Enter.
 2=Edit authority   3=Copy   4=Delete   5=Display authority   7=Rename
 8=Display description 13=Change description

Opt Object   Type   Library   Attribute Text
CON20000 *FNTRSC QFNT240LA1 FNTRCHRSET Latin1-Times New Roman-Roman
CON20000 *FNTRSC QFNT300LA1 FNTRCHRSET TIMES NEW ROMAN LATIN 1-ROMAN

Parameters for options 5, 7 and 13 or command
===>
F3=Exit F4=Prompt F5=Refresh F9=Retrieve F11=Display names and types
F12=Cancel F16=Repeat position to F17=Position to F24=More keys

```

Figure 75. Fonts with the same object name, different libraries

One of the tasks the PSF/400 printer writer job performs is to determine the printer resolution. Therefore, in the preceding example, only the second CON20000 font resource object is selected for printing to a 300-pel printer even if the QFNT240LA1 library was higher in the library list.

4.5 Outline fonts

Traditionally, fonts are stored as *raster* fonts. Each font is stored as a bit pattern (bitmap) for each and every character in a character set and once for every size and weight/posture (medium, bold, italic, bold italic). The bitmapped font is resolution-specific, so these large storage requirements are repeated for fonts of different pel densities. For host-resident raster fonts, there is a delay in printing while the raster sets are downloaded to the printer.

An *outline* font is an alternative means of storing a font. Each character is stored only once for each weight or posture. The stored outline font is defined using vector mathematics to describe its shape. This means the font may be drawn by the printer at a wide range of point sizes (1 to 999 points). Outline fonts may also be referred to as scalable or vector fonts (Figure 76).

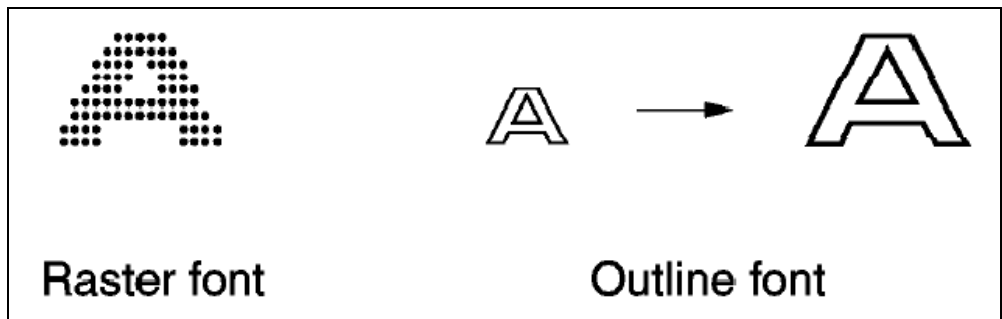

Figure 76. Representation of a raster font and an outline font

Previously, AFP outline fonts were only found as printer-resident fonts. Now products, such as the AFP Font Collection, contain host-resident AFP outline

fonts and tools, such as the OS/2 Type Transformer can produce AFP outlines from Adobe Type 1 PC fonts.

4.5.1 Downloading host-resident outline fonts

Version 3.0 Release 2.0 and Version 3.0 Release 7.0 introduced limited support (through program temporary fixes (PTFs)) for downloading AFP outline fonts by PSF/400. This was restricted to certain coded fonts in the IBM AFP Font Collection product. At Version 4.0 Release 2.0, scaling information for downloaded outline fonts is added in the printer file and in DDS. This is similar to the current point size parameter on the FONT keyword, except that the range is from 0.1 to 999 points.

A printer that supports outline font download is required, such as an IBM AFCCU printer. Although printers, such as IBM Network Printers, use resident outline fonts, they cannot receive downloaded outline fonts.

4.5.2 Why use an outline font

Outline fonts are extremely efficient in performance terms. One outline font can replace a range of raster font point sizes, thereby reducing font download time, the number of raster fonts that must be kept at the host, and the font storage requirements at the printer. They are also easy to specify (for example, an 18-point host-resident font) to be downloaded. Consider this example:

```
OVRPRTF FILE(QSYSPRT) DEVTYPE(*AFPDS) FNTCHRSET(MYLIB/CZH200 T1V10285 18.0)
```

You can also specify the same printer-resident font to be invoked at the printer:

```
OVRPRTF FILE(QSYSPRT) FONT(2304 18.0)
```

Note: You do not need to specify the data-stream device type to use a printer-resident font.

Outline fonts are resolution-independent. Therefore, as printers become capable of printing at higher resolutions, the application investment in using outline fonts is maintained. Because it is the device that rasterizes the outline font sent to it, you can use the same AFP outline font sent to a printer (at 240, 300, or 600 dpi) or sent to a display at various resolutions. The fonts may be placed in a single library because they no longer have a resolution attribute.

Migrating existing raster fonts may be achieved either by obtaining the equivalent IBM AFP outline font or purchasing an equivalent Type 1 scalable font (PC-based) from a font vendor and converting it to an AFP outline font using IBM Type Transformer. If the application uses older font families such as Sonoran Serif or Sonoran Sans Serif, these are similar to Times New Roman and Helvetica, but they are not identical. The reason for this is that the Sonoran fonts and other fonts were hand-tuned for best quality on 240-pel printers and cannot be converted to outline font technology. This is why IBM recommends the adoption of the strategic Expanded Core fonts (Times New Roman, Helvetica, and others). These fonts are available as host raster and outline fonts, and commonly as printer-resident outline fonts. This is particularly the case for new applications. Note that Helvetica is an equivalent of Arial, widely used in PC applications.

A practical example for using outline fonts is to print large characters (for example, at 720-point (approximately 10 inches high)) in retail store applications

or on packing carton delivery slips. Prior to using outline fonts, the two principle means of printing large characters were to use graphic symbols sets or scale printer-resident fonts using the CHRSIZ DDS keyword. For a discussion of the pros and cons of using these methods, see A.4.1, “Using GDDM fonts” on page 283. For details of their use, please refer to *AS/400 Printing III*, GG24-4028. Note that CHRSIZ is not supported on newer printers, such as the IBM AFCCU printers, because of the trend towards outline fonts.

4.5.3 Scalable fonts for MULTIUP and COR

When the applicable PTF is applied and the QPRTVALS data area is set up as described in 10.5.4, “Using the QPRTVALS data area” on page 217, the AS/400 system will always select a scalable font for printing with MULTIUP or COR (multiple-up and Computer Output Reduction) or when the spooled file attributes specify FONT(*CPI). This only applies for IBM AFCCU printers.

If the font identifier in the printer device description is between 300 and 511 (inclusive), this font is selected and scaled to an appropriate point size. If the font in the device description is not between 300 and 511, the AS/400 system uses font 304. Font 304 is a scalable Gothic font that is supported by these printers for almost all single-byte character set (SBCS) code pages except Arabic, Cyrillic Greek, Hebrew, Latin 2/3/4/5, and Symbols.

Another recommended font is 416, a scalable Courier Roman font that is supported for almost all SBCS code pages except Japanese Katakana.

To activate this function, ensure the printer writer is ended and then type:

```
CHGDTAARA DTAARA(QUSRSYS/QPRTVALS (6 1)) VALUE('Y')
```

This places the character Y in the sixth byte of the QPRTVALS data area. To change the default to something other than 304, enter:

```
CHGDEVPRD DEVD(printername) FONT(416 12.0)
```

See Table 11 for information on PTF support for scalable fonts with MULTIUP and COR.

Table 11. PTF support for scalable fonts with MULTIUP and COR

Version/release	PTF
V3R1	SF43120
V3R2	SF43431
V3R6	SF42712
V3R7	SF44664
V4R1 and above	Base operating system

4.6 Font substitution

PSF/400 uses font substitution tables to perform *font substitution*. Font substitution may also be referred to as *font mapping* and takes one of the following forms:

- **Font ID to Font ID:**

This occurs when the requested font is not available on the printer but a similar one is available. This is printer-resident to printer-resident font substitution, which is the most common type of substitution.

- **Font ID to Font Character Set:**

This occurs when the target printer has no resident fonts, or when resident fonts are disabled by the Create/Change Print Services Facility Configuration (CRTPSFCFG/CHGPSFCFG) command or an equivalent WRKAFP2 command. See 4.8, "Disabling resident font support" on page 106, for details of disabling printer-resident fonts.

One reason for there being no printer-resident fonts might be when the device is actually a process emulating a printer (for example, Facsimile Support/400 or the Distributed Print Facility (DPF) of Print Services Facility/2 (PSF/2)). Some older IBM printers also did not have resident fonts (for example, the 3900-1, 3825, and 3835).

- **Font Character Set to Font ID:**

This substitution of a host-resident font for a requested printer-resident font occurs only when one of the following situations is true:

- The host font character set was not found and the printer supports resident fonts.
- The printer does not accept downloaded fonts (most impact printers).

Reasons for not finding the host font character set include: not authorized to use that font, the font was not in the user's library list, or the font exists, but at a different resolution than that of the printer.

Note: A code page may be substituted in the same way as a font character set with the exception that a code page is resolution-independent. Therefore, this does not give rise to a substitution.

The particular fonts substituted in the previous cases are documented in Appendix D of *AS/400 Printer Device Programming*. OfficeVision/400 has its own table of substituted fonts, which is documented in *Setting Up Printing in an OfficeVision/400 Environment*, SH21-0511.

4.6.1 Suppressing font substitution messages

Normally font substitution is logged in the job log, and a message, such as the following example, is sent to the message queue defined in the printer device description (usually QSYSOPR):

```
PQT2072 Font substitution was performed
```

At Version 4.0 Release 2.0, these messages may be suppressed, if desired, using the FNTSUBMSG keyword on the CRTLPSCFG or CHGPSFCFG command. The default is *YES to continue generating these messages as at present. Otherwise, you can block the messages as follows:

```
CHGPSFCFG PSFCFG(NP17) FNTSUBMSG(*NO)
```

Messages indicating that font substitution failed are not blocked.

4.7 Font table customization

Until recently, customers had to accept the system's internal font mapping. In addition, the use of applications, such as OfficeVision/400 (where only font IDs are specified), restricted the customer's choice of fonts.

Version 3.0 Release 7.0 introduced the ability to create your own font mapping tables. These are searched before the existing system tables. This facility applies only to AFP printers, and PSF/400 is required. Tables may be created to control any or all of the following examples:

- Host-resident font character set to printer-resident font ID mapping
- Printer-resident font ID to host-resident font character set mapping
- Host-resident to printer-resident code page mapping
- Printer-resident to host-resident code page mapping

Since there are several commands associated with font table customization, type the following command:

```
GO CMDFNTTBL
```

The display appears as shown in Figure 77.

```
CMDFNTTBL                                Work with Font Tables

Select one of the following:

  Commands
  1. Add Font Table Entry                  ADDFNTTBL
  2. Change Font Table Entry              CHGFNTTBL
  3. Create Font Table                    CRTFNTTBL
  4. Delete Font Table                   DLTFNTTBL
  5. Display Font Table                  DSPFNTTBL
  6. Remove Font Table Entry             RMVFNTTBL

  Related Command Menus
  7. AFP Commands                       CMDAFP
  8. Font Resource Commands              CMDFNTRSC
  9. PSF Configuration Commands         CMDPSFCFG

                                          Bottom

Selection or command
====>

F3=Exit  F4=Prompt  F9=Retrieve  F12=Cancel  F16=Major menu
(C) COPYRIGHT IBM CORP. 1980, 1996.
```

Figure 77. Work with Font Tables menu on a V3R7 system

4.7.1 Creating the font tables

It is first necessary to create one or more font tables, and then add, alter, or delete entries from them. Only one of each of the four font substitution cases previously described may be created using the Create Font Table (CRTFNTTBL) command. They are assigned a system-supplied name as follows:

***PHFCS** Printer to **H**ost-resident **F**ont **C**haracter **S**et

This creates a table named QPHFCS in the QUSRSYS library, object type *FNTTBL.

- *PHCP** **Printer to Host-resident Code Page**
This creates a table named QPHCP in the QUSRSYS library, object type *FNTTBL.
- *HPFCS** **Host to Printer-resident Font Character Set**
This creates a table named QHPFCS in the QUSRSYS library, object type *FNTTBL.
- *HPCP** **Host to Printer-resident Code Page**
This creates a table named QHPCP in the QUSRSYS library, object type *FNTTBL.

4.7.2 Adding a font table entry

As an example, if you want to use a host-resident font with OfficeVision/400, you must either use a printer that does not support resident fonts (these tend to be larger system printers such as the 3820 and 3835) or switch off printer-resident font support using the CHGPSFCFG command (WRKAFF2 command at Version 3.0 Release 1.0 and Version 3.0 Release 6.0). Your specified font ID is then substituted to a host-resident font according to the font tables documented in Section D.5 of *AS/400 Printer Device Programming*. This may not be an exact substitution (the table identifies these exceptions), or you may want to use a custom-supplied host font. To do this, you need to add an entry to the QPHFCS font table.

Suppose you are using FGID 75 (Courier 12 cpi) in your OfficeVision/400 documents. This is normally substituted to C0S0CR12, which is not an exact match. If you have the Core Interchange Fonts installed on your system, you can substitute C04200B0 instead as shown in Figure 78.

```

                                Add Font Table Entry (ADDFNTTBL)

Type choices, press Enter.

Font table . . . . . > *PHFCS          *PHFCS, *HPFCS, *PHCP, *HPCP
Printer to host font:
Printer font:
Identifier . . . . . > 75              1-65535
Width . . . . . > 120                 1-32767, *NONE, *PTSIZE
Attributes . . . . . *NONE            *NONE, *BOLD, *ITALIC...
Graphic character set . . . . *SYSVAL  Number, *SYSVAL
Point size . . . . . *WIDTH          1.0-999.9, *WIDTH, *NONE
Host font:
Font character set . . . . . > C04200B0  Name
Type . . . . . *RASTER                *RASTER, *OUTLINE

                                                                Bottom
F3=Exit  F4=Prompt  F5=Refresh  F12=Cancel  F13=How to use this display
F24=More keys
```

Figure 78. Adding a different printer-resident to host-resident font substitution

Note: The WIDTH keyword in the previous command refers to the characters per inch value (12 in our example) divided into 1440. These values for the common

cpi sizes (10, 12, 15, etc.) may be listed on the printer IPDS font listing (see the example in Figure 74 on page 90).

You must also ensure that any writers to printers configured as *IPDS, AFP=*YES are ended before attempting to change the font tables. Otherwise, you receive messages similar to:

```
Cannot allocate object QPHFCS in library QUSRSYS
Font table QPHFCS in library QUSRSYS not changed
```

If this occurs, use the following command to locate which writers are still active:

```
WRKOBJLCK OBJ(QUSRSYS/QPHFCS) OBJTYPE(*FNTTBL)
```

You can then determine whether to end the writers immediately, or defer the font table changes to a later time. Successful addition of the font table is reported by:

```
Font table entry added to font table QPHFCS
```

This may be checked using the DSPFNTTBL command, which causes the following display, as shown in Figure 79, to appear.

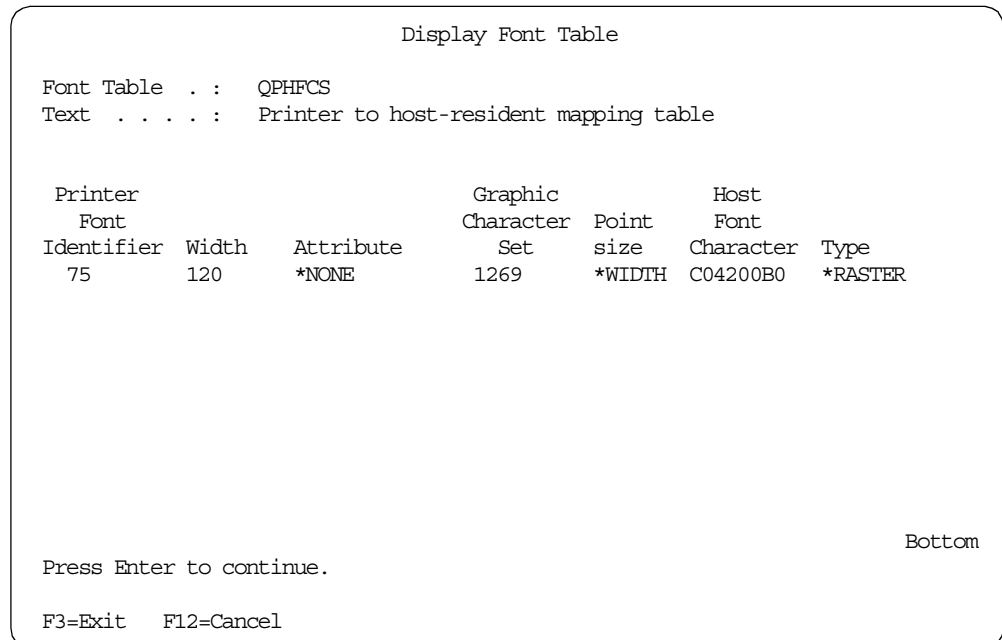

Figure 79. Displaying entries in a customized font table

A final point to note in the case of OfficeVision/400 is that you are probably still restricted to monospaced (fixed-pitch) host-resident fonts because the alignment of tabs and columns is incorrect if typographic fonts (variable-spaced) are used.

4.7.3 Other font table commands

The remaining commands are self-explanatory:

- Change Font Table Entry
- Delete Font Table
- Remove Font Table Entry

4.7.4 Customer-defined font ranges

If your operating system is prior to Version 3.0 Release 7.0, there is an alternative method to customizing font tables. This uses a new function added to Version 3.0 Release 1.0 and upwards through PTFs for customer-defined printer-resident fonts. This works as explained here:

1. Disable the printer's resident font support as described in 4.8, "Disabling resident font support" on page 106.
2. Identify up to five host-resident font character sets that you want to use.
3. Rename these to C0USERF1 through C0USERF5 using the Rename Object (RNMOBJ) command.
4. Specify any or all of the font IDs, 65501 to 65505, in your application. These are mapped to the character sets in the range C0USERF1 to C0USERF5.

One use of this feature might be in OfficeVision/400 where you have a host-resident font that is actually a barcode set or a signature. You can use the preceding procedure to refer to it by a font ID.

This support is enabled by the PTFs shown in Table 12.

Table 12. PTF details for customer-defined font ranges

Version/Release	APAR	PTF	Cum-pak
V3R1	SA54431	SF31920	6198
V3R2	SA54431	SF32128	6233
V3R6	SF55079	SF39367	-
V3R7 and later	Base operating system		

4.8 Disabling resident font support

You must disable resident font support on the printer. Otherwise, normal font substitution will occur (printer-resident font to printer-resident font, as described in 4.6, "Font substitution" on page 101). To do this, follow these steps:

1. Ensure the printer writer is ended:

```
ENDWTR PRINP17 *IMMED
```

2. Use the WRKAFP2 command (V3R1 and V3R6) to display or print the current status of the data area created by WRKAFP2:

```
WRKAFP2 DEVD(PRTNP17) PRINTONLY(*YES)
```

Re-running the command resets all parameters to their default value unless you explicitly re-define them again.

3. Issue the WRKAFP2 command with the Disable Resident Fonts keyword enabled plus any special settings you may have already:

```
WRKAFP2 DEVD(PRTNP17) DRF(*YES) . . .
```

4. For V3R2, V3R7, and later, use the CRTPSFCFG or CHGPSFCFG commands instead of WRKAFP2. These may be changed without affecting other settings:

```
CHGPSFCFG PSFCFG(PRTNP17) RESFONT(*NO)
```

Note that the earlier WRKAFP2 command uses the syntax “disable resident fonts?”. The CHGSFCFG command asks: “resident font support?”. Therefore, the yes or no response is different.

4.9 Using a resource library list

A PSF configuration object allows you to specify which particular libraries are searched for AFP resources (including fonts). This might be for reasons of:

- **Security:** Can restrict libraries searched.
- **Performance:** Searching fewer libraries is faster
- **Device resolution issues:** AFP resources created at different pel densities can be placed in appropriate libraries. For example, there is no point in searching 240-pel font libraries when using a 300-pel printer.

The PSFCFG object may define a user resource library, a device resource library, or both. The former is searched first, but may have *NONE specified, which means that only the device resource library is searched.

The relevant keywords are User Resource Library (USRRSCLIBL) and Device Resource Library (DEVRSCLIBL).

```

Change PSF Configuration (CHGPSFCFG)

Type choices, press Enter.

PSF configuration . . . . . PSFCFG      > NP17
  Library . . . . .                >  QGPL
User resource library list . . . USRRSCLIBL  *JOBLIBL
Device resource library list . . DEVRSCLIBL  > QFNT300CPL
                                          > QFNT300LA1
                                          > AFPRSCLIB
                                          + for more values
IPDS pass through . . . . . IPDSPASTHR     *NO
Activate release timer . . . . . ACTRLSTMR  *NORDYF
Release timer . . . . . RLSTMR            *NOMAX
Restart timer . . . . . RESTRIMR          *IMMED
SNA retry count . . . . . RETRY           2
Delay time between SNA retries  RETRYDLY   0
Text 'description' . . . . . TEXT         > 'PSFCFG object for IBM Networ
Printer 17'

                                          More..
F3=Exit  F4=Prompt  F5=Refresh  F12=Cancel  F13=How to use this display
F24=More keys

```

Figure 80. Part of a CHGPSFCFG command

The example in Figure 80 shows how the command might be used with a printer that only supports 300-pel fonts from the AS/400 system. The user resource library is set to *JOBLIBL, meaning the job's current library list is searched for any AFP resources referenced. The device resource library list names three libraries, the first two containing 300-pel fonts, and the last library possibly containing AFP resources in 300-pel format and unique to that printer.

If all the resources used for the print jobs are contained in a few libraries, consider setting USRRSCLIBL to *NONE so only the device resource library is searched.

The PSF configuration object could be specified in one or multiple printer device descriptions, as shown in Figure 81.

```

Change Device Desc (Printer) (CHGDEVPRT)
Type choices, press Enter.

User-defined object:
  Object . . . . . > NP17          Name, *SAME, *NONE
  Library . . . . . > QGPL         Name, *LIBL, *CURLIB
  Object type . . . . . > *PSFCFG  *DTAARA, *DTAQ, *FILE...
  Data transform program . . . . . *NONE      Name, *SAME, *NONE
  Library . . . . .              Name, *LIBL, *CURLIB
  User-defined driver program . . . *NONE      Name, *SAME, *NONE
  Library . . . . .              Name, *LIBL, *CURLIB
  Text 'description' . . . . . '9.28.252.110'

Bottom
F3=Exit  F4=Prompt  F5=Refresh  F10=Additional parameters  F12=Cancel
F13=How to use this display  F24=More keys

```

Figure 81. Change Device Desc (Printer) (CHGDEVPRT)

4.10 Font capturing

PSF/400 can download fonts to certain IPDS printers when they are configured as *IPDS, AFP=*YES in their device description. Since Version 3.0 Release 1.0, these fonts are stored across job boundaries on the basis that the next job is likely to use them. This is known as *font caching*. Once the PSF/400 writer is ended, all AFP resources in the printer (including fonts) are deleted.

With Version 4.0 Release 2.0, a printer can hold these fonts after the writer is ended, if so desired. This also applies if the printer is subsequently powered off. Printing performance is improved because the fonts no longer need to be downloaded. This is especially beneficial to users of double-byte fonts because these fonts are large in size. This process is known as *font capturing*.

Two steps are necessary to implement font capturing:

1. Mark the desired font resources as eligible for capture.
2. Define the printer to be capable of font capturing.

4.10.1 Font resources eligible for capture

Not all fonts contain the necessary information in the internal structured fields to permit them to be uniquely identified. If fonts have this information, they are said to be *marked*. Examples of tools that can mark fonts are APSRMARK (contained within PSF/MVS) and Type Transformer (available as an option within the IBM Font Collection). Version 4.0 Release 2.0 of OS/400 also has this function.

However, if the font does not have the required structured fields present, these tools have no effect.

Details of the fonts that may be captured are:

- Outline Fonts (single and double-byte):

These include AFP outline fonts shipped with the IBM AFP Font Collection and are already marked. If Type Transformer is used to create new outline fonts, the option to mark them is user-selectable.

- Raster Fonts (single byte)

Some of the newer fonts in the IBM Font Collection are marked. Earlier fonts may not be marked if they do not contain the necessary information as described above. If the user attempts to mark these fonts, a warning message is issued.

- Raster Fonts (double-byte):

These fonts contain the necessary information to enable them to be marked.

Note: A raster font is actually built from two font resources: the font character set and the code page. Therefore, both of these resources must be marked if they are to be eligible for capture.

4.10.2 Marking a font resource

An OS/400 font resource may be a font character set, code page, or coded font. These are OS/400 objects with the attribute of FNTCHRSET, CDEPAG, or CDEFNT. Note that a coded font cannot be marked for capture. Use the WRKFNTRSC command to quickly locate font resources on your system and DSPFNTRSCA to identify whether they have been marked (FNTCAPTURE *YES). Displaying the font attributes also tells you the pel density of the font character set as shown in Figure 82.

```
Display Font Resource Attributes
System: ALICEH02
Font Resource . . . . . : COH200A0
Library . . . . . : QFNT300LA1
Object attribute . . . . . : FNTCHRSET
Pel Density . . . . . : 300
Font Capture . . . . . : *YES
Date . . . . . : 12/16/94
Time . . . . . : 00:00:00.00
Text . . . . . : HELVETICA LATIN1-ROMAN MED 11-PT

Press Enter to continue.

F3=Exit F12=Cancel
```

Figure 82. Displaying attributes of a font resource on a V4R2 system

Remember that FNTCAPTURE *YES means that the font is *eligible* for capture, not that it *has* been captured by the printer.

When creating OS/400 font resources from resources sent from other systems, use the CRTFNTRSC command. This command and the new CHGFNTRSC command now allow a user to mark the font as eligible for capture. This is done by entering the following command:

```
CHGFNTRSC FNTRSC (QFNTPCL/COD0GT13) FNTCAPTURE (*YES)
```

This causes the current date and time stamp to be added to the font, which is what PSF/400 uses to track whether the font in the printer is truly the same as the one being referenced in the spooled file (just having the same object and library name is not enough). The default for FNTCAPTURE is *NO.

The CRTFNTRSC command has an additional keyword *FILE. This tells PSF/400 to use the font capture information stored within the font. If no information is found, then *NO is assumed. This allows users to mark fonts on other systems (for example, using APSRMARK) and then send them for use on the AS/400 system.

4.10.3 Defining the printer for font capture

In addition to defining the font resources, the user must define the printer as being capable of font capturing. This is done by modifying the printer's PSF Configuration Object. The keyword is FNTCAPTURE and the options are *YES or *NO. This permits the user to selectively define which printers will support font capturing.

At the time this redbook was written, only the IBM AFCCU printers are capable of using the font capture facility.

4.10.4 Considerations for font capture

Note: You must be authorized to use a font resource, regardless of whether it has been captured in the printer. This is because some fonts might be security sensitive (for example, a Magnetic Ink Character Recognition (MICR) font used for printing checks or a font representing someone's signature). Therefore, exercise caution when marking such fonts, because many printers today can be accessed from more than one system.

Captured fonts remain in the printer indefinitely unless overwritten by later font capture instructions. The host printer writer cannot alter this condition.

If a concern exists about font resources from user libraries being captured and "polluting" the printer font resources, there are several actions you can take to guard against this:

- Change the USRRSCLIBL parameter in the PSFCFG object to *NONE. This means that user libraries are not searched for resources.
- Run the CHGFNTRSC command against any fonts in user libraries specifying FNTCAPTURE(*NO).
- Suppress font capturing altogether by setting FNTCAPTURE to *NO in the PSFCFG object.

4.11 Creating AFP fonts with Type Transformer

Type Transformer is a Windows-based PC tool that can be used to create AFP fonts for the AS/400 system. All the source Type 1 fonts used to build the AFP Font collection are supplied or you can use your own Type 1 fonts. Here is an example of building single-byte fonts and moving them to the AS/400 host.

A single byte AFP font can be created in five steps:

1. Select the **Output Font** resolution. Valid options are any combination of AFP Outline, 240-pel raster, and 300-pel raster. In the following example, AFP Outline and 300-pel raster fonts are created.
2. Select the  icon to choose the Type 1 (Typefaces) to be converted to AFP Fonts (Figure 83). Any directory that has valid Adobe Type 1 outline fonts (*.pfb extension) will have its typeface displayed. You can create Adobe Type 1 outline fonts from TrueType fonts with the FontLab editor supplied in this package.

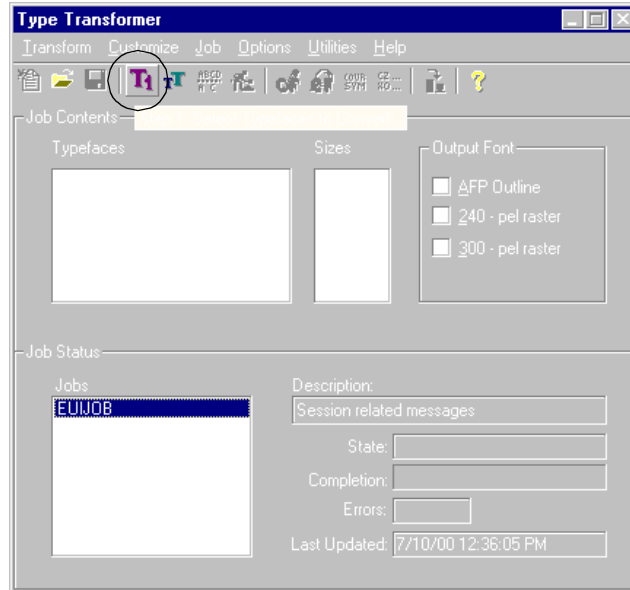

Figure 83. Type Transformer: T1 icon selection

Highlight the typefaces, and click **OK**. You can choose one or several typefaces to convert as long as the *.pfb files reside in the same directory (Figure 84 on page 112).

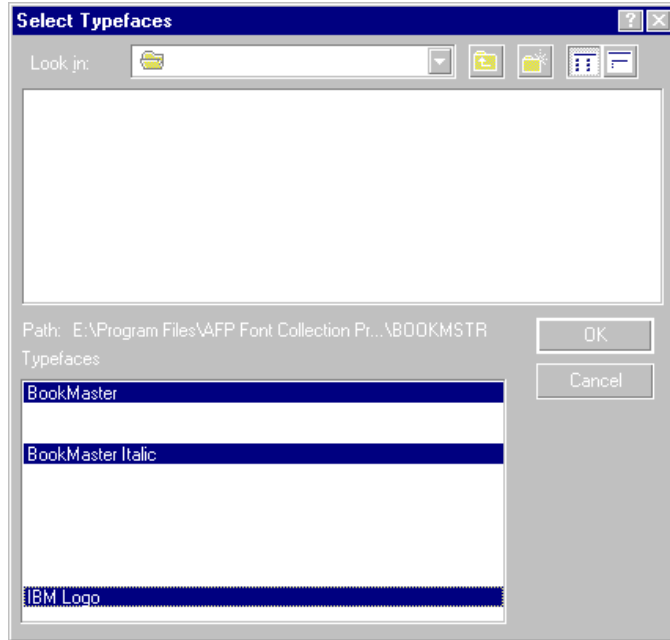



Figure 84. Selecting multiple typefaces

3. If you are creating raster fonts or coded fonts, select the  icon to choose the point sizes to be used (Figure 85).

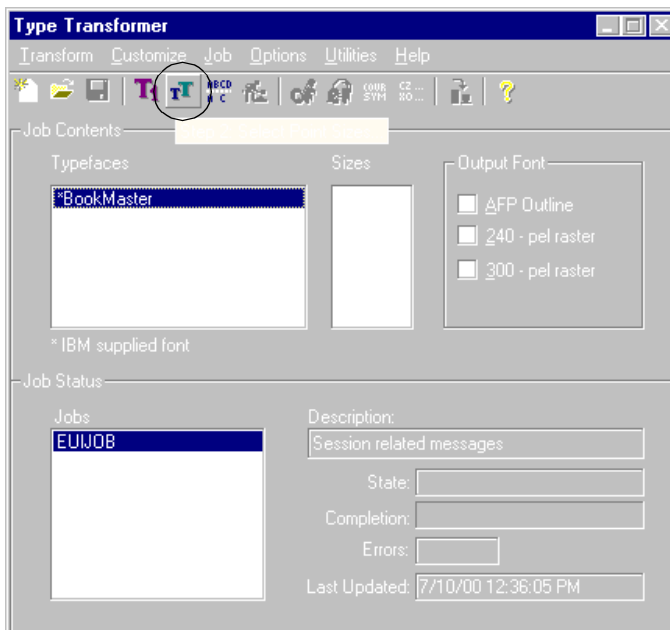

Figure 85. Selecting a point size

You can select one or multiple point sizes by highlighting the point sizes to be used and clicking **Add** (Figure 86). There is an option to create fractional point sizes. If you choose this option, you are required to complete the character set name or the coded font name. More information is provided in the *Type Transformer User's Guide* that comes online with this product.

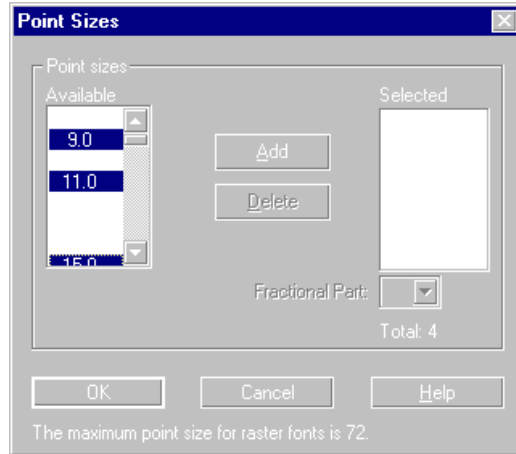



Figure 86. Choosing multiple point sizes

4. Choose a filter by clicking the  icon to reduce unnecessary characters (Figure 87). This is an optional step, but it may help keep the size of the AFP font to a minimum. More information on character lists can be found in the *Type Transformer User's Guide*.

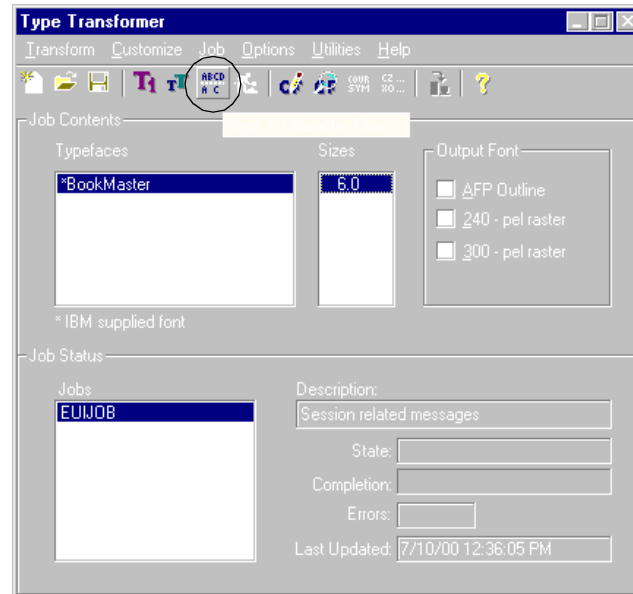

Figure 87. Choosing a filter

Select the character list, and click **Open** (Figure 88 on page 114).

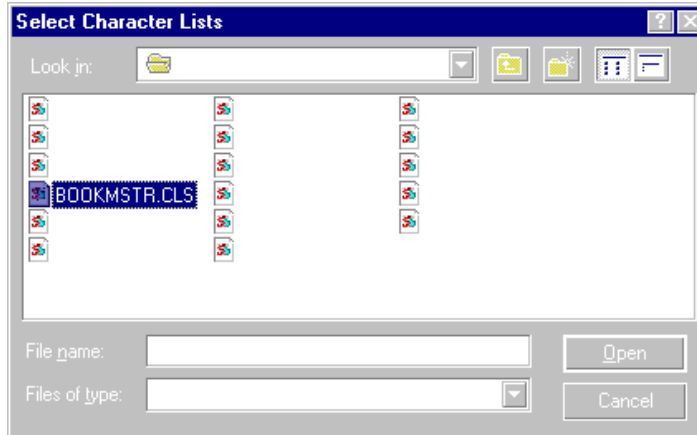



Figure 88. Select Character Lists

5. Start the job by clicking the  icon (Figure 89).

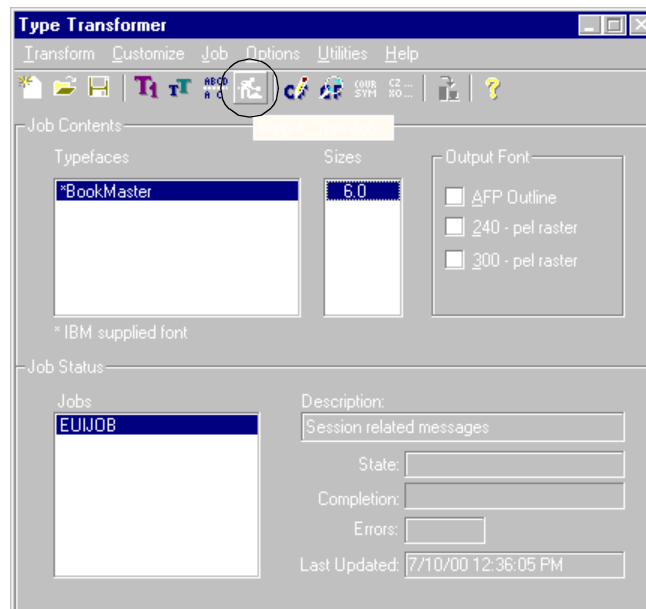

Figure 89. Starting the job

Give the job a name (up to eight characters) and a description. Select the type of reports to generate, and click **Transform** (Figure 90).

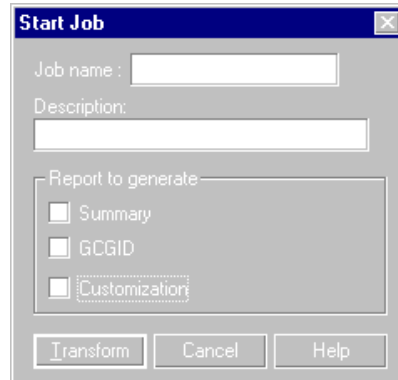







Figure 90. Start Job

There are several additional options that you can use to customize the AFP output fonts:

- You can define coded fonts using the  icon.
- You can rename the coded fonts using the  icon.
- You can customize output typeface names using the  icon.
- You can customize character set font names using the  icon.

Once the font conversion job is complete, store the fonts on the AS/400 system using the  icon (Figure 91).

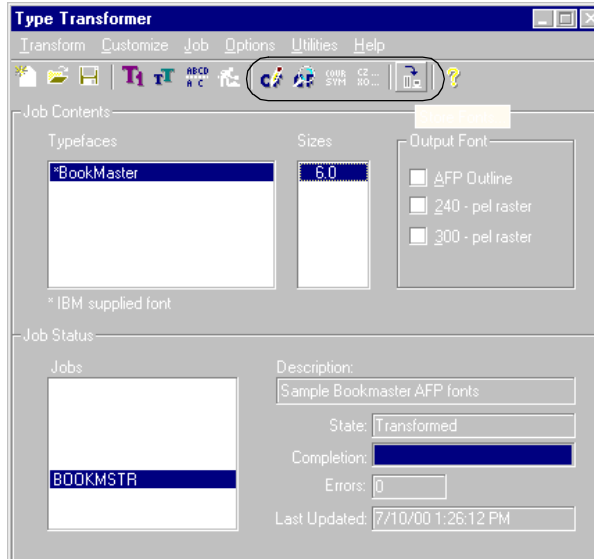

Figure 91. Storing converted fonts

You can select the output fonts to store from the window shown in Figure 92 on page 116. Choose the platform, highlight the font objects to store, and click **Store**.

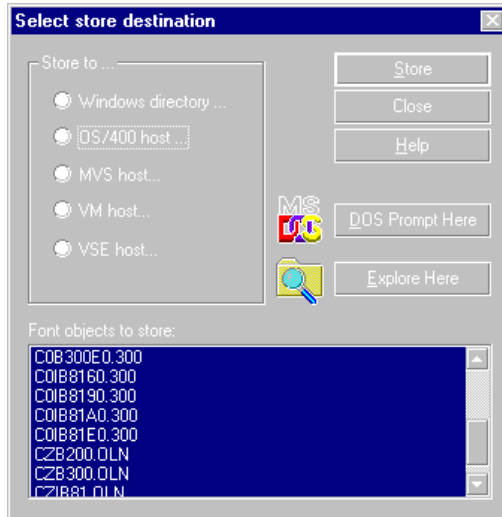

Figure 92. Select store destination

Personal Communications V4.3 (or higher) or Client Access/400 and Object Rexx for Windows is required to use this store function.

Select the session ID where your AS/400 system is logged on. Provide the system name, select the output libraries, and provide a user ID and a password. Type Transformer stores the font resources on your AS/400 host (Figure 93).

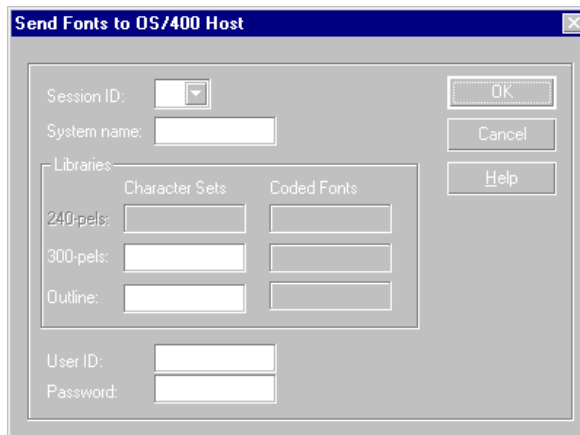

Figure 93. Storing fonts on the AS/400 host

Chapter 5. The IBM AFP Printer Driver

The IBM Advanced Function Presentation Printer (AFP) Driver is a printer driver used to produce AFP output from PC applications. This means it can be used for printing PC documents on high-speed AFP system printers, produce electronic forms using your favorite PC application, and even create signatures and logos from existing or newly-scanned sources. The driver is included with Client Access/400 or may be downloaded from the World Wide Web free of charge.

5.1 Overview

The AFP Printer Driver is supported in the following environments:

- Windows 3.1
- Windows for Workgroups 3.11
- WIN OS/2
- Windows 95
- Windows 98
- Windows 2000
- Windows NT

The AFP drivers are similar to standard PC drivers in that they are small in size, fit on a standard diskette, and are installed in the normal manner (for example, through the Windows Control Panel). They differ from normal printer drivers in that the output is Advanced Function Presentation Data Stream (AFPDS) instead of the more usual Printer Control Language (PCL), Personal Printer Data Stream (PPDS), PostScript, and others. You “print” the output to a port or file the same as any Windows printer drivers.

5.1.1 Why use the AFP Printer Driver

The AFP Printer Driver offers a variety of functions to optimize your output:

- **Overlays:** Creating overlays (electronic forms) with the AFP Printer Driver means you can use your existing PC application to design a form and are limited only by the capabilities of that application. You can use advanced desktop processing features, such as curved boxes and shading together with basic functions such as text alignment and spell checking. Company letterhead, terms and conditions, or an invoice layout are common examples.
- **Page segments:** If you already have your company or client's logos in PC format, you can include these in overlays, or perhaps create them as a separate AFP resource called a *page segment*. Signatures are another candidate. Captured at a PC-attached scanner, they can be imported into a PC application and then “printed” as an AFP page segment. Individual page segments representing user's signatures can then be printed along with the letterhead overlay.
- **AFP documents:** Using the AFP Printer Driver with Client Access/400 network printing, you can send your PC documents for printing on a high-speed AS/400 AFP system printer instead of overloading your desktop PC printer.

5.2 Installing the AFP Printer Driver

The following instructions use Client Access/400 for Windows 95/NT V3R1M2 as an example. They assume that Client Access/400 is already installed without the AFP Printer Driver installed.

1. This procedure requires that you re-boot your PC. End all other applications before beginning this process.
2. Open the **Client Access** folder and then the **Accessories** folder.
3. Double-click the **Selective Setup** icon.
4. At the Install Client Access - Component Selection window, select the **Printer drivers** checkbox (Figure 94), and click **Change**.

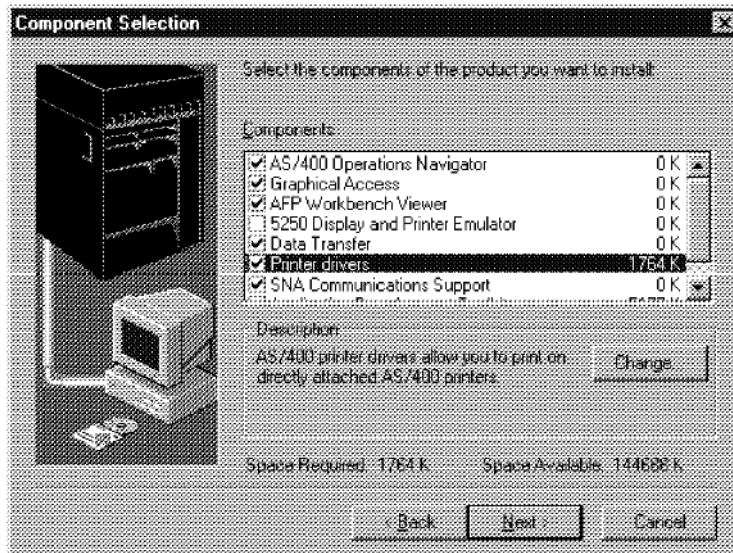

Figure 94. Client Access/400 Component Selection display

5. Select the **AFP printer driver** (Figure 95).

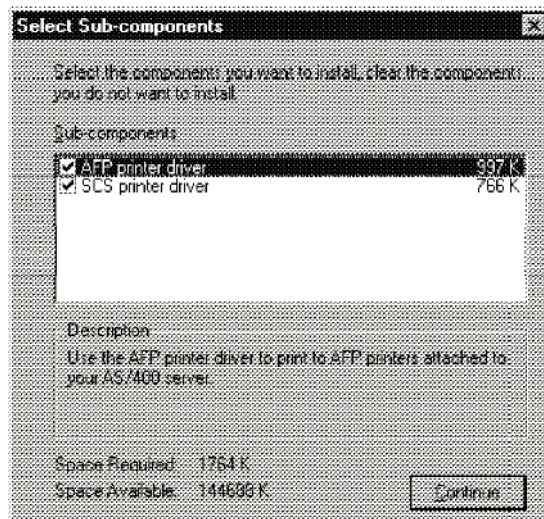

Figure 95. Installing the Client Access/400 printer drivers

6. Click **Continue**.
7. Click **Next**.
8. When you are satisfied with the settings, click **Next**. The installation begins, taking a few moments to load the driver.
9. At this point, you may choose to view the README.TXT file.
10. Select the option to re-boot your PC at this time.
11. When your PC has restarted, a Welcome to Client Access window is displayed. Close this window, and open the **Printers** folder.
12. Click **Add Printer**.
13. Select the **Local printer** radio button (Figure 96).

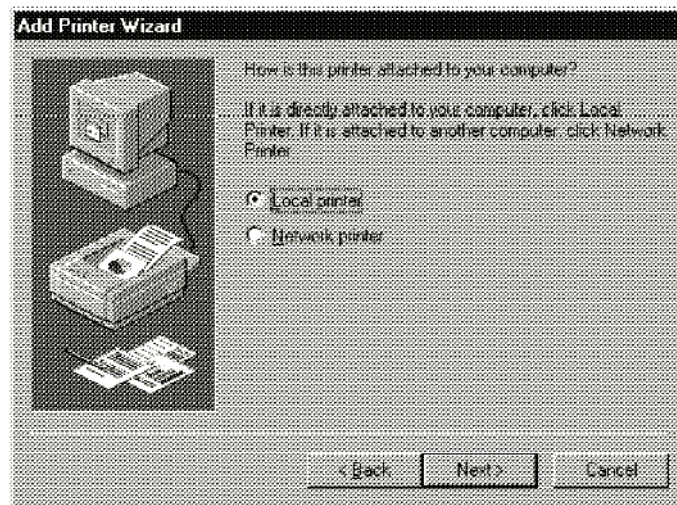

Figure 96. Selecting a local printer driver

14. At the Manufacturer and Printer window, select **IBM** and an AFP driver that is appropriate for your environment (Figure 97).

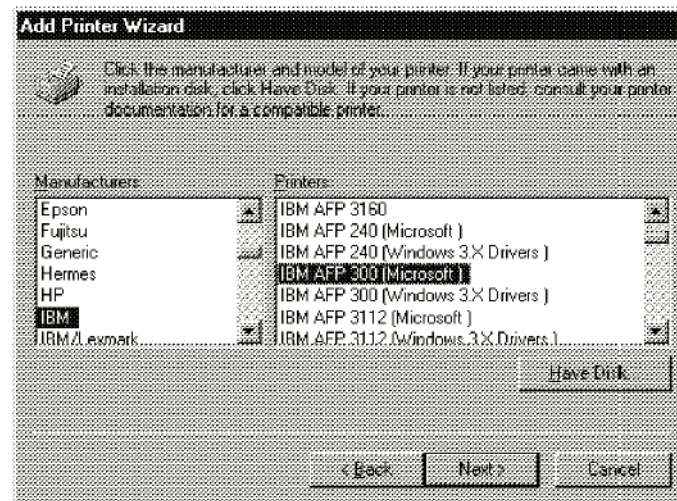

Figure 97. Manufacturer and printer window

The available drivers and their uses are:

- **IBM AFP 144:** Generic AFP driver for impact printers.
Use this driver for creating AFPDS output at approximately 144 dpi. This is used only for printing to IPDS impact printers such as certain IBM 6400, 4247, and 4230 models.
- **IBM AFP 600:** Generic AFP driver for any IPDS laser printer at 300 or 600 dpi.
- **IBM AFP 3160:** Creates 240-pel output for the 3160 Model 1 printer.
- **IBM AFP 240 (Microsoft):** Generic 240 dpi AFP driver for 32-bit Windows systems (Windows 95).
- **IBM AFP 240 (Windows 3.x drivers):** Generic 240 dpi AFP driver for 16-bit Windows systems such as Windows 3.1, Windows for Workgroups, and WIN-OS/2.
- **IBM AFP 300 (Microsoft):** Generic 300 dpi AFP driver for 32-bit Windows systems (Windows 95).
- **IBM AFP 300 (Windows 3.x drivers):** Generic 300 dpi AFP driver for 16-bit Windows systems such as Windows 3.1, Windows for Workgroups, and WIN-OS/2.
- **IBM AFP xxxx (Microsoft):** Printer-specific AFP driver for 32-bit Windows systems (Windows 95).
- **IBM AFP xxxx (Windows 3.x drivers):** Printer-specific AFP driver for 16-bit Windows systems such as Windows 3.1, Windows for Workgroups, and WIN-OS/2.
- **IBM AFP Facsimile Support/400:** Specific driver for use with Facsimile Support/400.
This AFP driver is used for faxing PC documents with the Facsimile Support/400 program product. It has support for Image only.
- **IBM AFP WPM/2:** Specific driver for ImagePlus Workstation Program/2.
This AFP driver is used for producing AFP output from the IWPM/2 product. It also has support for Image only.

You can install more than one AFP print driver just as you can install multiple printer drivers for one physical printer (for example, PCL and Postscript drivers).

15. The next window shows a list of the ports on your PC. Select **FILE** (Figure 98) for creating overlays and page segments or a printer port to print documents.

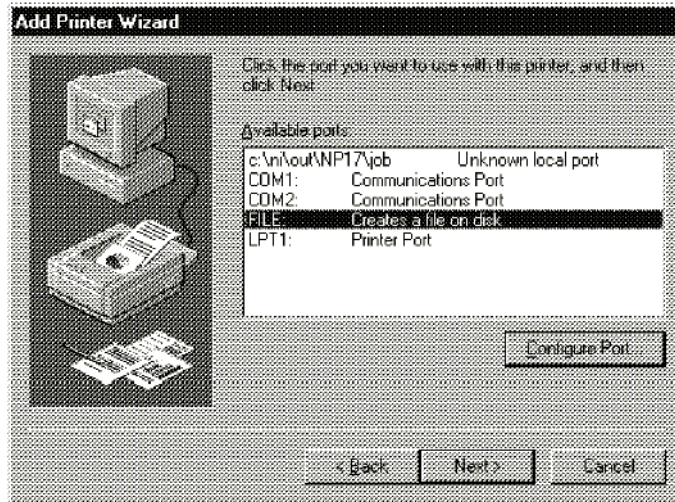

Figure 98. Connecting the printer driver to a port

16. Leave the next window with the defaults for printer name and “no” for the default Windows printer.
17. Change the invitation to print a test page to **No**.
18. Click **Finish**. Then a new printer icon is created (Figure 99).

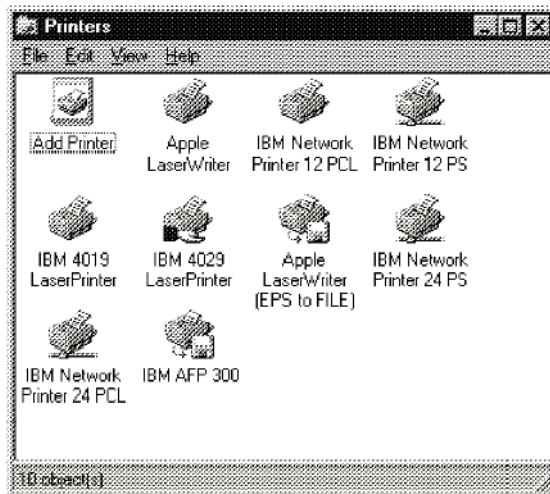

Figure 99. Completed Add Printer process

The driver is now ready for use with your PC applications. To learn how to do this, refer to 5.3, “Creating an overlay” on page 122, or 5.4, “Creating a page segment” on page 126.

5.2.1 Installation from the World Wide Web

The latest version of the AFP Printer Driver may be obtained from the World Wide Web at: <http://www.printers.ibm.com/afpdr.html>

However, only the version supplied with the IBM program products are licensed and, therefore, supported by IBM. Copies of the driver from the Web are supplied “as is”.

To add the AFP Printer Driver, download the installation program to a convenient directory (C:\TEMP, for example). Then perform the following steps:

1. Create a destination directory to receive the files (C:\AFPDRV in this example). Ensure the directory name has no more than eight letters in its title, or the driver files will not be unpacked.
2. Click **Start->Run** and enter the string shown in Figure 100. Be sure to include the "/D" option to create any sub-directories that may be needed. You can specify the destination directory to be a diskette or a network drive if required.
3. After you unpack the files, the procedure to install the driver is the same as already described (from step 11 in 5.2, "Installing the AFP Printer Driver" on page 118). However, in this case, at the Manufacturer and Printer window, you need to select **Have Disk**. Then indicate the drive and directory where you unpacked the files.

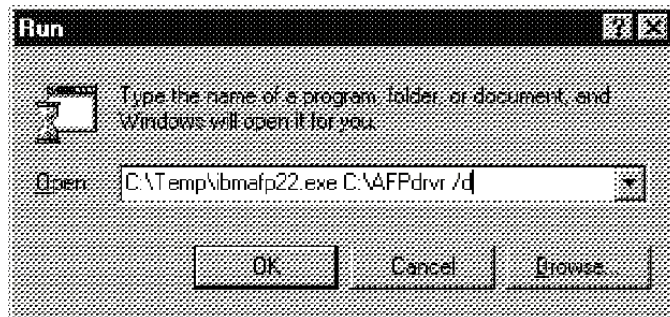

Figure 100. Running the AFP Printer Driver installation program

5.3 Creating an overlay

The following steps show you how to set up the driver for producing overlays (electronic forms). You can perform this process globally for Windows 95 or when you select the driver from your PC application (through the Properties button).

1. Open the Printers window, and select the **AFP Printer Driver** icon. Right-click, and select **Properties**.
2. Select the **Details** tab, and then select **Setup**. The display shown in Figure 101 appears.

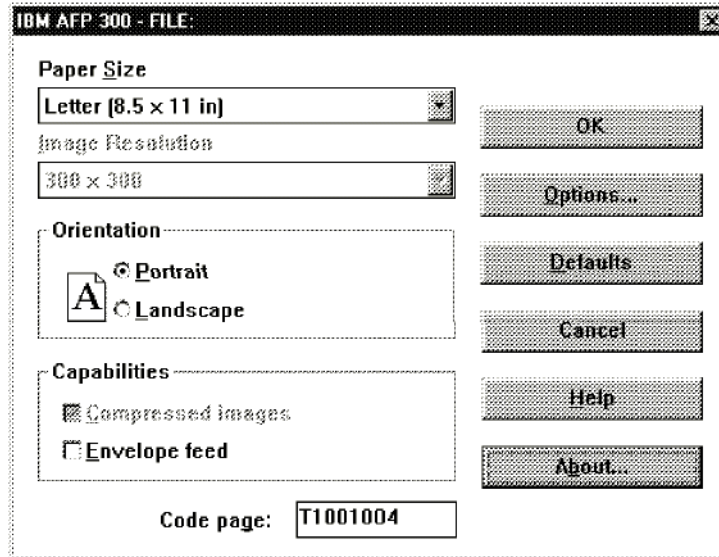

Figure 101. AFP Printer Driver Setup

- a. If the Code page box is empty, click **Defaults**, and the T1001004 code page (Personal Computer: Desktop Publishing) is added.
 - b. Change **Paper Size** as required (for example, A4 or Letter).
 - c. Check that the Image Resolution dialog box matches that of your target printer. If you are using a specific driver for your printer model, this box is grayed out as shown in Figure 101.

Note: Most desktop laser printers, including the IBM Network Printers, use AFP resources at 300 dpi even if they subsequently print the output at 600 dpi. If you are unsure of your printer's resolution, refer to the tables in Appendix E, "Printer summary" on page 313.
 - d. Leave the Orientation dialog box at its default (Portrait), unless you want to print documents in landscape. This setting is overridden by the application's Page Setup (or similar), and is only used for applications that do not have page setup control such as Microsoft Paintbrush.
 - e. Leave the Compressed Images parameter selected. If you use an AFP Print Driver for an older IBM printer, such as an IBM 3820, this parameter is not selectable.
3. Click **Options...** to display the window shown in Figure 102 on page 124.

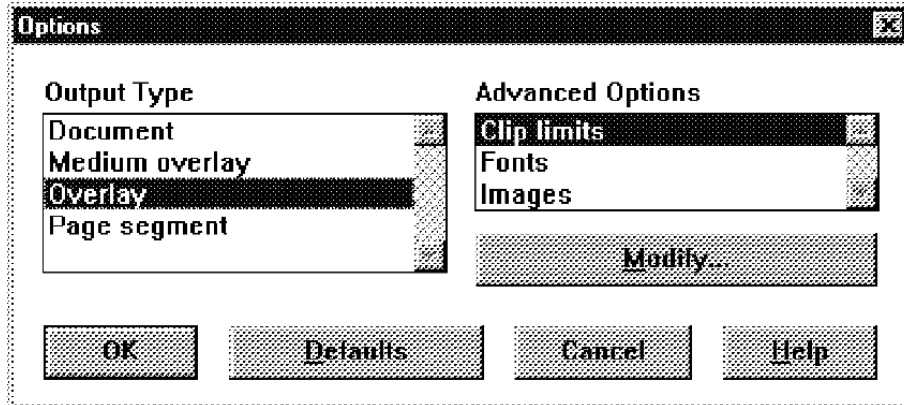

Figure 102. AFP Printer Driver setup: Options—Overlay

4. Change the Output Type to **Overlay** (not Medium overlay).
 - a. Select the **Clip limits** option, leave the Clip Method as **Offset plus size**, and change **Top** and **Left** to “0” (Figure 103).
 - b. The values for Height and Width are in proportion to the paper size you defined earlier but may be changed if required.

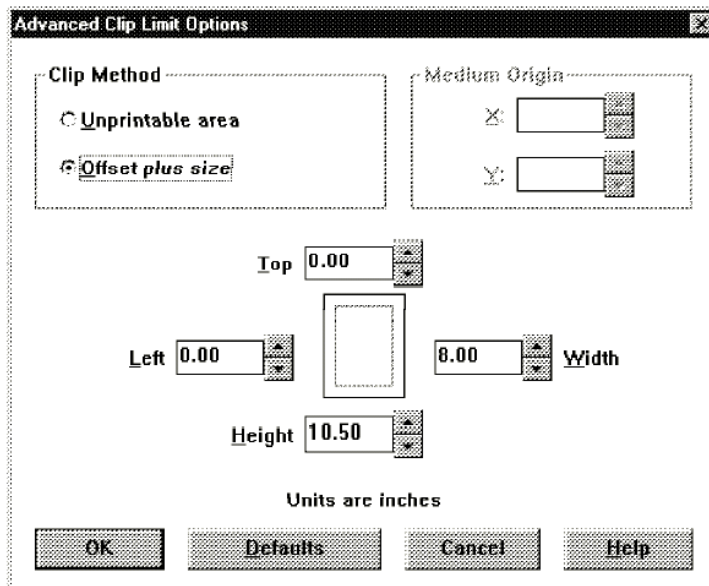

Figure 103. AFP Printer Driver setup options: Clip limits

- c. Select **OK** to save these settings and return to the Options window.
5. For now, no changes are required to the Fonts window. This is discussed further in 5.5, “Text versus image” on page 129.
6. No changes are required to the Images window.
7. Click **OK** to save these settings and return to the main page of the AFP Printer Driver Setup.
8. Click **OK** to close the Setup window.
9. Click **OK** to close the Printer Properties window.

To use the AFP Printer Driver with your PC application, simply select the print command (sometimes a separate printer setup is available).

10. Select the required AFP Printer Driver.
11. Click **Properties** to check or change your output type or if you want to change any of the settings.
12. When you confirm the print operation, a Print To File dialog box is shown with a default directory location. If you have shared folders support (that is, your AS/400 disks are mapped to your PC as local disks), you can print directly to a convenient shared folder as shown in Figure 104. You can give the file any name you want, but a good convention is to use the suffix **.OLY** (for Overlay).

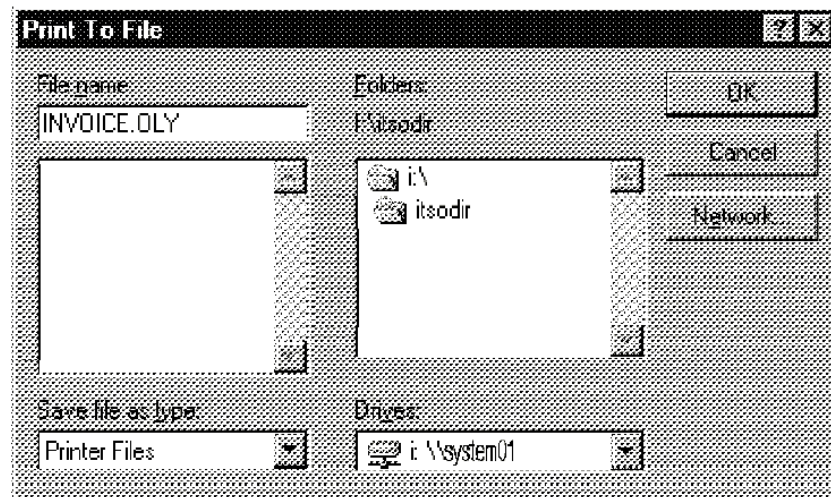

Figure 104. Print to File on Shared Folder

Note: In this example, we assume that the i:\ drive is assigned to QDLS.

If you do not have shared folders support, you need to file transfer the AFP file using another method such as Client Access/400 file transfer or File Transfer Protocol (FTP) if your PC and AS/400 system are using TCP/IP. The latter method is described in 5.6.2, “File transfer of AFP resources using FTP” on page 130.

13. As a one-time step, you must create a physical file on the AS/400 system to receive the resource. Use the following command:

```
CRTPF FILE(SIMON/UPLOAD) RCDLEN(32766)
      TEXT('File for transfer for AFP resources') LVLCHK(*NO)
```

14. Copy your AFP file from the folder into the physical file as shown here:

```
CPYFRMPCD FROMFLR(ITSODIR) TOFILE(SIMON/UPLOAD)
      FROMDOC(INVOICE.OLY) TRNTBL(*NONE)
```

In the preceding example, we copied an overlay (INVOICE.OLY) created using the AFP Printer Driver from a shared folder (ITSODIR) to a physical file (UPLOAD). If you used Client Access file transfer or FTP, the object is already in the physical file.

15. Create the OS/400 AFP resource:

```
CRTOVL OLY(SIMON/INVOICE) FILE(SIMON/UPLOAD) MBR(UPLOAD)
      TEXT('Coffee Shop Invoice')
```

This is now an AFP resource that may be used with your applications as described in Chapter 3, “Enhancing your output” on page 67. It is an OS/400 object with an object type of *OVL.

Note: Steps 13, 14, and 15 have been automated into an OVERLAY command provided with the AS/400 Programming Sampler available from the AS/400 printing Web site, which is: <http://www.ibm.com/printers>

Select **Resources for AS/400**, and click **Downloads/freetools**.

5.4 Creating a page segment

The following steps show you how to set up the driver for producing page segments (AFP images such as graphics, logos, and signatures). You can perform this process globally for Windows 95 or when you select the driver from your PC application (through the Properties button).

1. Follow the process described in 5.3, “Creating an overlay” on page 122, up to step 3 (“Click on **Options**”).
2. Change the output type to **Page Segment**.
3. The only advanced options available are Clip limits and Images. Select the **Clip limits** dialog box, and leave the Clip Method as **Offset plus size**.

The next step depends on the image you want to create as a page segment. For an image that occupies most or all of the page, leave the Top/Left and Width/Height settings at their defaults. If you are producing a company logo or signature, which typically occupies a small area of the page, you can:

- a. Place your logo in the top left-hand area of the page.
- b. In the AFP Printer Driver Setup, change Paper Size to **User Defined** (for example, 2 inches wide by 1.5 inches deep). See Figure 105.

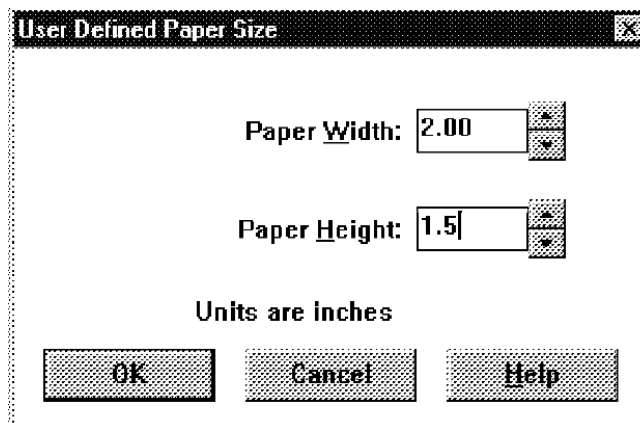

Figure 105. Changing the User Defined Paper Size

This reduces the amount of surrounding white space you capture with the page segment and makes positioning it easier. See Figure 106 for an example.

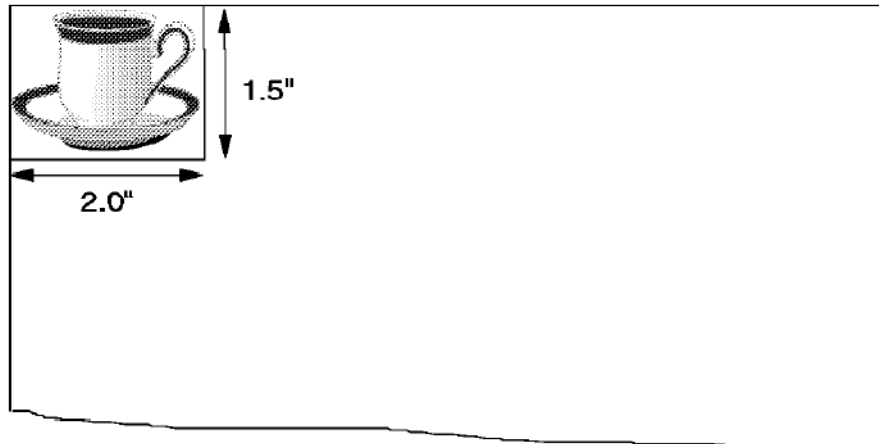

Figure 106. Clip art logo in a PC application

Alternatively, you can use this method:

- a. At the Advanced Clip Limits window, enter the coordinates of the top left-hand corner of the logo (or area you want to capture) in **Top** and **Left**.
- b. Change **Width** and **Height** as required (for example, 2 inches by 1.5 inches).

This latter method does not work with some newer applications such as Lotus Freelance. A third method is to import the logo into Microsoft Paintbrush (Windows 3.x only) and select the Partial option from the print command (that is, print only the area of your drawing that you specify).

To use the AFP driver with your PC application, simply select the print command (sometimes a separate printer setup is available).

4. Select the required AFP Printer Driver.
5. Click **Properties** to check or change your output type or if you want to change any of the settings.
6. When you confirm the print operation, a "Print to File" dialog box is shown with a default directory location. If you have shared folders support (that is, your AS/400 disks are mapped to your PC as local disks), you can print directly to a convenient shared folder as shown in Figure 107 on page 128. You can give the file any name you want, but a good convention is to use the suffix .PSG (for Page Segment).

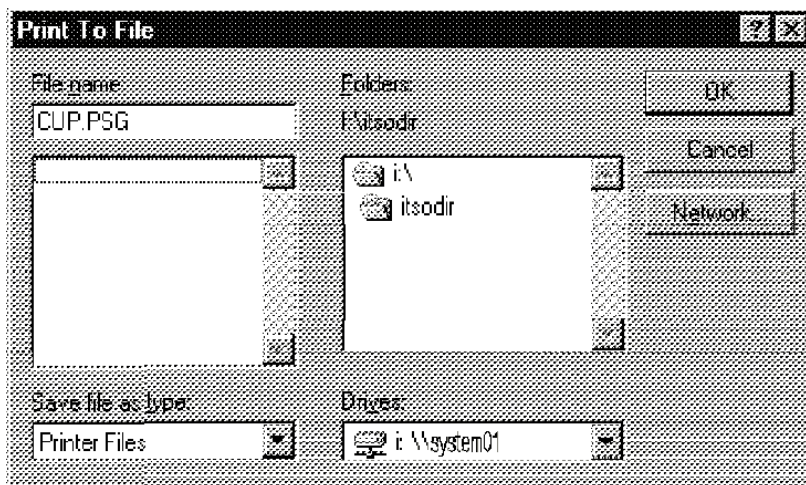

Figure 107. Print to File on a shared folder

Note: In this example, we assume that the i:\ drive is assigned to QDLS.

If you do not have shared folders support, you need to file transfer the AFP file using another method such as Client Access/400 file transfer or FTP if your PC and AS/400 system are using TCP/IP. The latter method is described in 5.6.2, “File transfer of AFP resources using FTP” on page 130.

7. As a one-time step, you must create a physical file on the AS/400 system to receive the resource. Use the following command:

```
CRTPF FILE(SIMON/UPLOAD) RCDLEN(32766)
      TEXT('File for transfer for AFP resources') LVLCHK(*NO)
```

8. Copy your AFP file from the folder into this physical file:

```
CPYFRMPCD FROMFLR(ITSODIR) TOFILE(SIMON/UPLOAD)
      FROMDOC(CUP.PSG) TRNTBL(*NONE)
```

In the preceding example, we copied a page segment (CUP.PSG) created using the AFP Printer Driver from a shared folder (ITSODIR) to a physical file (UPLOAD). If you used Client Access file transfer or FTP, the object is already in the physical file.

9. Create the OS/400 AFP resource:

```
CRTPAGSEG PAGSEG(SIMON/CUP) FILE(SIMON/UPLOAD) MBR(UPLOAD)
      TEXT('Logo - coffee cup')
```

This is now an AFP resource that may be used with your applications as described in Chapter 2, “Advanced Function Presentation” on page 35. It is an OS/400 object with an object type of *PAGSEG.

Note: Steps 7, 8, and 9 have been automated into a “SEGMENT” command provided with the AS/400 Programming Sampler available from the AS/400 printing Web site at: <http://www.printers.ibm.com/products.html>

Then, select **AS/400 application coding sample**.

5.5 Text versus image

Most versions of the AFP Printer Driver allow you to print text as text rather than as image. This is the default setting controlled by the Fonts option in Advanced Options from the main Setup window. This means that text in your PC document is produced as text wherever possible with graphics and shading being produced as image. It is more efficient to produce text-based overlays and documents in terms of both the file size and the speed of printing. For example, a standard business overlay created as image at 300 pel resolution might be 100K in size. That same overlay utilizing text may be less than 5K.

You need to install the IBM AFP Font Collection (described in 4.3, “Which fonts are available” on page 93) on the AS/400 system where you intend to print the AFP resources. This is necessary to provide the PC code page used and to provide the AFP character sets. The latter are resolution-dependent (that is, 240 or 300-pel). Code pages are not resolution-dependent. The PC code page used with the AFP Printer Driver is located in library QFNTCDEPAG after installation of the IBM AFP Font Collection.

The driver produces text by mapping common PC fonts such as Arial and Times New Roman onto host AFP equivalents, or near-equivalents such as Helvetica and Times New Roman. The font table (IBMAFP.INI) is installed with the other driver files in the WINDOWS\SYSTEM directory. You can observe these mappings by clicking on a PC font together with the point size and style (Figure 108).

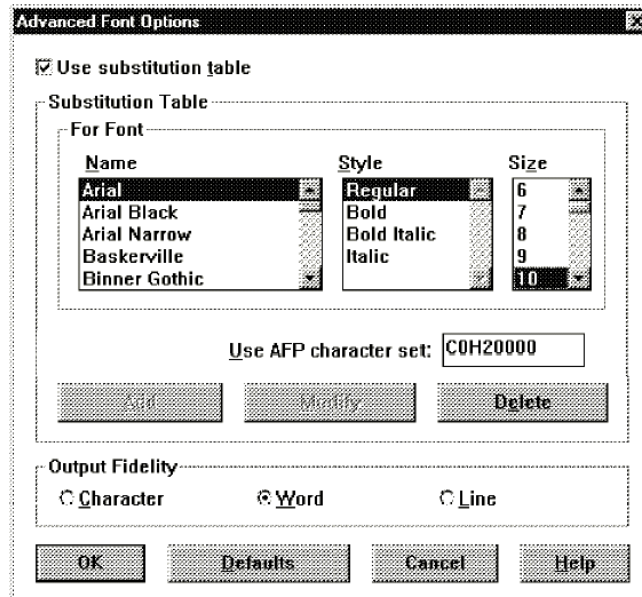

Figure 108. Advanced Font Options: Font substitution

If required, you can add your own mappings. For example, you can map Arial Narrow to the same Helvetica host character set or even a different host font altogether using the Add button. Changes may be made using the Modify and Delete buttons. These changes are recorded in another table, PENNUSER.INI, located in the WINDOWS directory.

You must ensure that all these fonts are available at print time and in the correct resolution (240 or 300-pel). Newer versions of the driver also allow the use of outline fonts. With outline fonts, you only need to specify the typeface (for example, CZH400 for Helvetica Bold) and all point sizes are mapped to it. Outline fonts are described in 4.5, "Outline fonts" on page 99.

The choice of whether to use text or image is made at the Advanced Options - Fonts dialog box for overlays and documents only. The Use Substitution Table checkbox is selected by default. This means your output will use AFP fonts where possible and image (raster) elsewhere. If you want the entire document printed as Image, de-select the checkbox. You can also experiment with Use text rules. This draws lines as text instead of as an image.

Note: Some versions of the driver (for example, Windows NT and earlier versions of the Windows 3.x drivers) do not support text output. Therefore, these drivers do not have the Fonts option available.

Using the AFP Viewer, you can check how your document is being produced (text, image, or both). See 5.6.3.1, "Using the AFP Viewer" on page 132.

5.6 Other AFP Printer Driver tasks

This section looks at customizing the AFP Printer Driver further, describes other file transfer methods for transferring the AFPDS output to the AS/400 system, and discusses some common problems.

5.6.1 Using the Images dialog box

Do not confuse this with printing the document in text or image. If any part of your document uses image, you can control its appearance by selecting the Images option and then one of four gray scale methods. You can also adjust the intensity and contrast controls. How much effect you see depends on the quality and capabilities of your printer.

These options are documented in the online help.

5.6.2 File transfer of AFP resources using FTP

If you do not have support for shared folders to directly print the AFP file to the AS/400 system, you may want to use TCP/IP file transfer using File Transfer Protocol (FTP) as described here. Both your PC and the AS/400 system must be using TCP/IP, and the FTP daemon must be running on the AS/400 system. Open a DOS Window, and refer to the example in Figure 109.

```

C:\>ftp lucyh01 1
Connected to lucyh01.systland.ibm.com.
220-QTCP at lucyh01.systland.ibm.com.
220 Connection will close if idle more than 60 minutes.
User (lucyh01.systland.ibm.com: (none)): simonh 2
331 Enter password.
Password: 3
230 USERID24 logged on.
ftp> bin 4
200 Representation type is binary IMAGE.
ftp> lcd temp 5
Local directory now C:\temp
ftp> cd simon 6
250 Current library changed to SIMON.
ftp> put test.oly 7
200 PORT subcommand request successful.
150 Sending file to member OLY in file TEST in library SIMON.
250 File transfer completed successfully.
1118 bytes sent in 0.00 seconds (1118000.00 Kbytes/sec)
ftp> quit 8
221 QUIT subcommand received.

C:\>

```

Figure 109. FTP session to transfer overlay resource

Notes

The steps shown in Figure 109 are explained here:

- 1 The FTP command to the TCP/IP name of your host system (you can use the IP address of the system instead).
- 2 Normal OS/400 user ID.
- 3 Normal password of your user ID.
- 4 This specifies a binary file transfer (not ASCII).
- 5 Change to the local (PC) directory where the AFP file is stored. You can type a different drive letter and subdirectory if appropriate (for example, D:\TEST\OVLS).
- 6 Change directory on the AS/400 system (actually changing the current library).
- 7 This copies the AFP file from the PC to the AS/400 system.
- 8 Type this to exit FTP.

Note: There is no need to create a physical file on the AS/400 system first. However, this method will overwrite the member in the file if it already exists.

5.6.3 Problem solving

A good source of commonly-experienced problems is the README file included with the driver (true for any product, but especially so for this one). Some of the more common problems and answers are:

- When installing the AFP Printer Driver on Windows 3.x, why is a dialog box displayed prompting me to insert a diskette with Serif fonts?

Answer: Ignore this dialog box. Select **Cancel** in the dialog box, and the installation will complete successfully.

- How do I know which version of the AFP Printer Driver I am using?

Answer: From the AFP Printer Driver's Setup window, click **About**. The version is similar to the IBM AFP Printer Driver for Windows Version 4.22. The same applies for a driver from the World Wide Web or IBM AFP Driver for Windows, Version 4.12 for the Client Access/400 version.

- When I print an AFP document or spooled file using an AFP resource where these have been created by the AFP driver, I get a message, "Code page T1001004 was not found".

Answer: If you are using text instead of image, you need this PC ANSI code page on the AS/400 system. See 5.5, "Text versus image" on page 129.

5.6.3.1 Using the AFP Viewer

Details on the use of the AFP Viewer can be found in several sources, including:

- Client Access for Windows
- *AS/400 Guide to Advanced Function Presentation and Print Services Facility*, S544-5319

The AFP Viewer can be a useful tool for diagnosing problems. For example, you can invoke the AFP Viewer to examine it using the overlay presented in Chapter 3, "Enhancing your output" on page 67. Follow these steps:

1. Open the Client Access folder, then the Accessories folder.
2. Double-click the **AFP Workbench Viewer** icon.
3. Select **File->Open**, and locate the file name of the overlay (CAFE.OLY, in this example). The resulting window is shown in Figure 110.

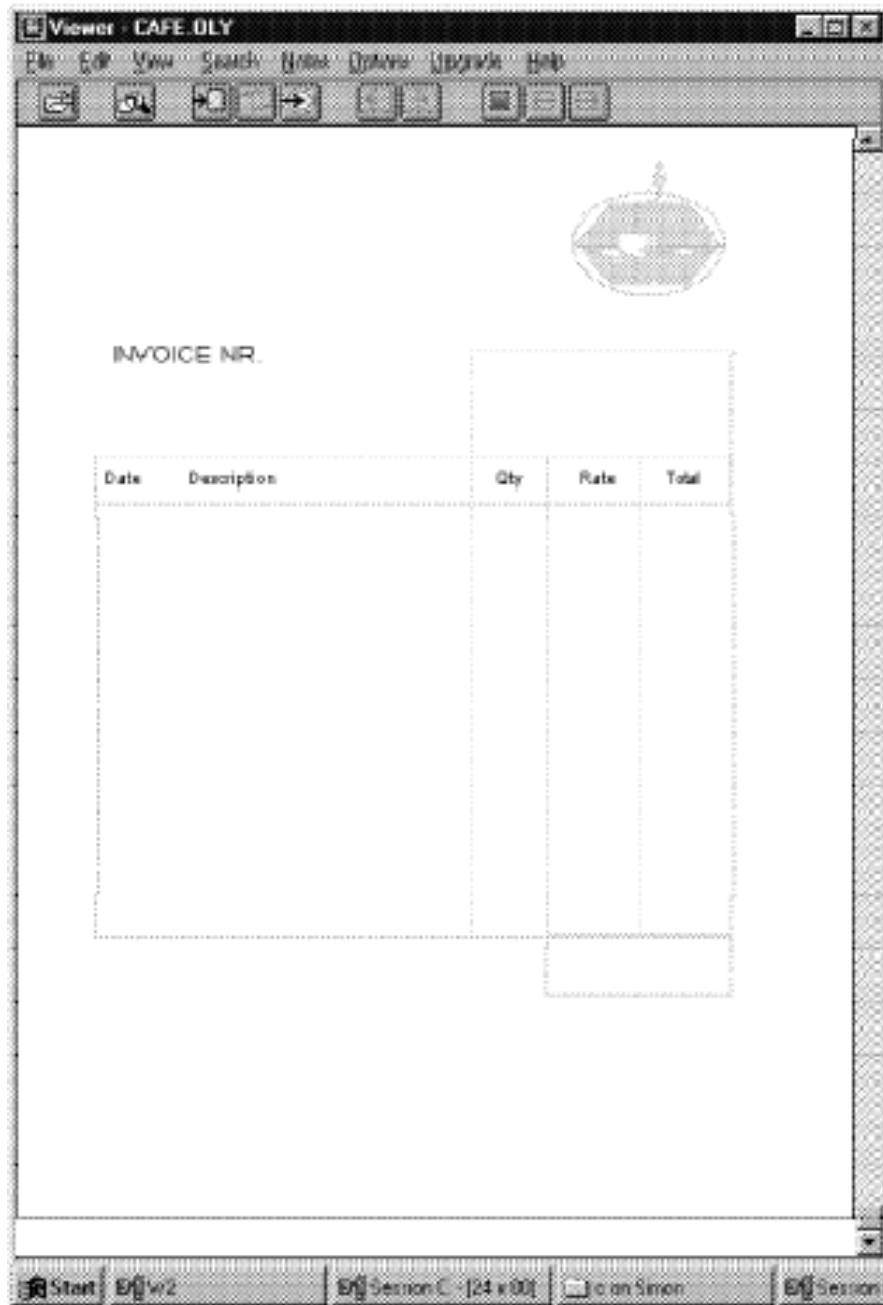

Figure 110. AFP overlay viewed using the AFP Viewer

If you click Options->Image View-> Color->and your favorite color, the AFP output is displayed in this color where the output is represented by *image* as opposed to a screen font. In this case, all the text in the overlay appears in black (text) and the logo and boxes in red (image).

This is useful for tracking performance problems with documents or resources created using the AFP printer driver (for example, when your all-text document has actually been created as image instead of more efficient text).

5.6.4 Performance of the AFP Printer Driver

The most important factor in the performance of the driver is whether it is produced in text or image and has already been discussed. Other factors that help maintain or improve performance are:

- Crop page segments (so you do not “print” the rest of the page as white space).
- Avoid excessive use of shading.
- Draw square boxes, rectangles, and so on rather than rounded boxes. It may be possible for the driver to print the former as text rules.

5.6.5 Creating AFP documents

The following steps take you through a one-time process to set up the driver for producing AFP versions of PC documents (for example, letters or reports produced using Lotus Word Pro or Microsoft Word, presentations using Lotus Freelance Graphics, and spread sheets from Microsoft Excel). These are just a few typical applications. As long as you are using a Windows or OS/2 application with a graphical user interface, you can “print” your output using the AFP printer driver.

You can perform this process globally for Windows 95 or when you select the driver from your PC application (through the Properties button).

1. Follow the process described in 5.3, “Creating an overlay” on page 122, up to step 3 (“Click **Options**”).
2. Change the output type to **Document**. Leave the Output Type option at the default.
3. Click **Form Definitions** and then click **Modify...** (Figure 111).

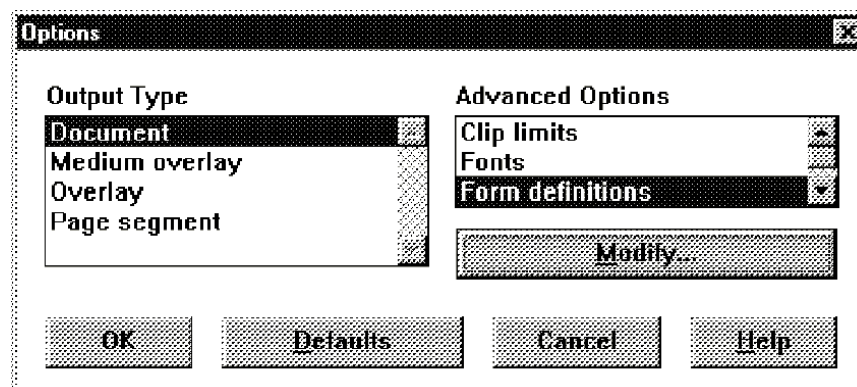

Figure 111. AFP Printer Driver setup: Options—Document

- a. If you want to specify duplex printing and use a different drawer, select the **Create inline form definition** checkbox and the other options as required. You can also specify an AFP overlay to be printed with your document, but you must ensure it is available as a separate resource on the system from which you want to print. In the example shown in Figure 112, we specified simplex printing from Drawer 2.

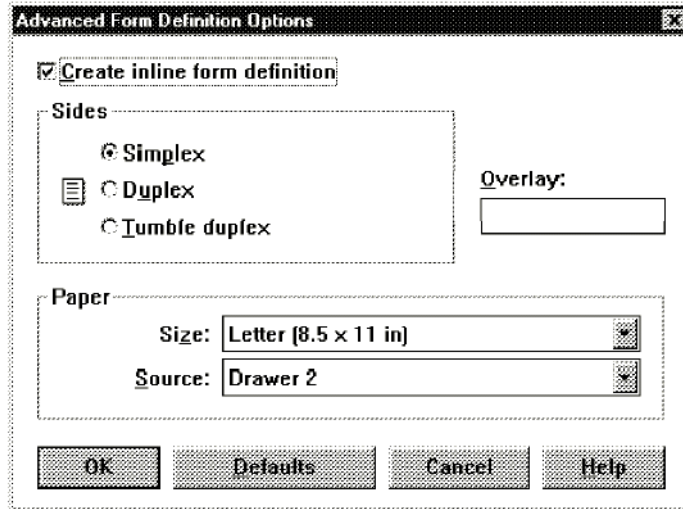

Figure 112. Selecting an inline form definition

- b. Click **OK** to save these settings, and return to the Options window.
4. Select **OK** to save these settings, and return to the main page of the AFP Printer Driver setup.
5. Click **OK** to close the Setup window.
6. Click **OK** to close the Printer Properties window.

The driver is now set up to produce AFP versions of your PC documents. To configure Client Access/400 Network Printing, see 9.2, “Client Access/400 Network Printing” on page 186.

Chapter 6. Host print transform

This chapter describes how the host print transform function can be used to convert SCS and AFPDS spooled files into an ASCII printer data stream. Host print transform has been available on the AS/400 system since Version 2.0 Release 3.0. New capabilities have been added in the versions and releases that have followed.

6.1 Host print transform overview

The host print transform function allows SCS-to-ASCII and AFPDS-to-ASCII conversion to take place on the AS/400 system instead of by 5250 emulators. Having the conversion take place on the AS/400 system provides the following advantages:

- Consistent output for most ASCII printers:

The host print transform function is capable of supporting many different types of ASCII printer data streams (for example, the Hewlett-Packard Printer Control Language (PCL), the IBM Personal Printer Data Stream (PPDS), and the Epson FX and LQ data streams). Having the conversion done on the AS/400 system ensures that the resultant ASCII printer data stream provides the same printed output regardless of the emulator or device to which the printer is physically attached.

- Support for many different ASCII printers:

Currently, each emulator supports a limited number of ASCII printers. With the host print transform function, most IBM printers and a large number of OEM printers are supported.

- Customized printer support:

Workstation customizing objects that come with the host print transform function can be updated by the user to change or add characteristics to a particular printer. Also, if the host print transform function does not have a workstation customizing object for a printer you want to use, you can create your own.

Figure 113 on page 138 shows an overview of some of the ways in which ASCII printers can be attached. Host print transform can be used to print to all of these printers.

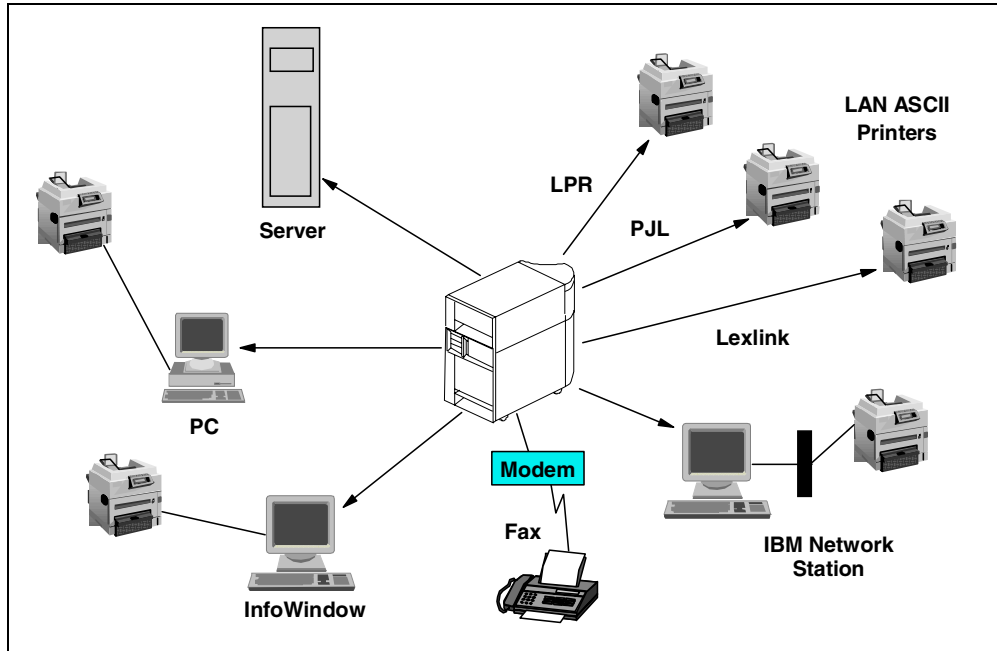

Figure 113. Host print transform overview

ASCII printers can be attached to displays, PCs, or directly to a LAN. For detailed information on printer attachment methods, see 1.7.7, “Printer attachment methods” on page 32.

Host print transform is also used with the remote system printing function (LPR/LPD). For more information, see Chapter 8, “Remote system printing” on page 171.

Finally, Facsimile Support/400 uses the host print transform when the fax controller used is an IBM 7852-400 ECS/Data Fax modem.

For host print transform considerations on performance, recoverability, fidelity, and currency, see 1.7.8.1, “PSF/400 IPDS printers versus HPT ASCII printers” on page 32.

6.2 Host print transform enhancements

The host print transform function continues to be enhanced either by PTFs or in new versions or releases of OS/400. Host print transform includes the following enhancements in V3R1 and later:

- AFPDS to ASCII transform and AFPDS to TIFF format transform; support for text, image, and barcode commands.
- New and enhanced tags for WSCST; new data streams supported.
- New API QWPZHPTTR brings the capabilities of the host print transform to the AS/400 application developers.
- New manufacturer type and model special values are added continuously by PTFs as part of the base code.

- Support DBCS printing; both the SCS to ASCII and the AFPDS to ASCII transform are supported (V3R2 and V3R7 and later).
- Image scaling enhancement; with this enhancement, Facsimile Support/400 received faxes are printed at the correct size.
- New barcodes, Royal Mail, and Japan Postal are now supported (V4R2).

Note: All the enhancements provided by PTFs are already available and are part of PTF cumulative tapes.

6.3 Host print transform process

SCS or AFPDS spooled files can be converted to an ASCII printer data stream and printed on ASCII printers. The host print transform converts the SCS data stream or the AFPDS data stream just before it is sent to the ASCII printer. The AS/400 spooled file contains SCS data or AFPDS data, not the converted ASCII data.

Note: IPDS spooled files cannot be converted by the host print transform.

AFP resources (such as fonts, overlays, page segments) referenced in AFPDS spooled files are converted into an ASCII printer data stream and passed to the ASCII printer.

Figure 114 shows the host print transform process.

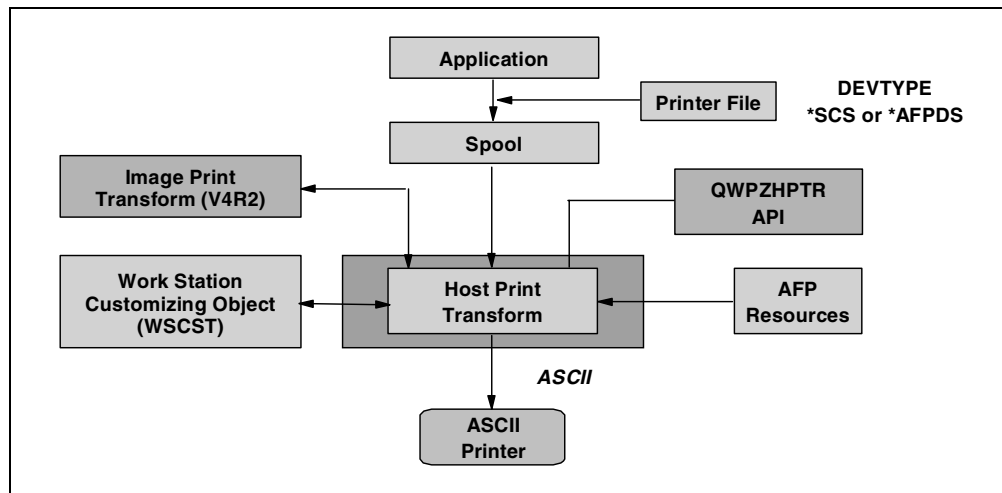

Figure 114. Host print transform process

The host print transform function generates an ASCII printer data stream for a number of IBM and non-IBM printers. To generate the different ASCII data streams, the host print transform function uses AS/400 system objects that describe characteristics of a particular printer. These objects are named Work Station Customizing Objects (WSCST) and you can customize them.

The host print transform API QWPZHPTR invokes the SCS transform or AFPDS transform according to the data stream type (printer attributes). This API brings the capabilities of host print transform to the AS/400 application developer.

In Version 4.0 Release 2.0, if the image print transform function is enabled, host print transform calls it for USERASCII spooled files. If the USERASCII spooled file contains Tag Image Format (TIFF), Graphics Interchange Format (GIF), OS/2 and Windows bitmap (BMP), or PostScript Level 1 data streams, it is processed by the image print transform. For detailed information on the image print transform function, see Chapter 7, "Image print transform" on page 161.

6.4 Enabling host print transform

To enable the host print transform function, you must change the printer device description, or if you are using remote system printing, change the output queue description. The following parameters are used by the host print transform function:

TRANSFORM	Host print transform function
MFRTYPMDL	Manufacturer, Type and Model
PPRSRC1	Paper source 1
PPRSRC2	Paper source 2
ENVELOPE	Envelope source
ASCII899	ASCII code page 899 support (symbols code page)
WSCST	Workstation customizing object and library

Host print transform is enabled when you specify *YES for the TRANSFORM parameter in the printer device description, or if you are using remote system printing, it is enabled in the output queue description.

Note: Client Access for Windows 95/NT creates or changes the printer device description based on the printer's session configuration. The host print transform function should be enabled by changing the session configuration on the personal computer and not the device description in the AS/400 system. For detailed information, see Chapter 9, "Client Access/400 printing" on page 185.

The host print transform function is also available when using remote system printing with CNNTYPE(*IP) or (*IPX) and the Send TCP/IP Spooled File (SNDTCPSPLF) command.

- For remote system printing, the TRANSFORM, MFRTYPMDL, and WSCST parameters are part of the Create Output Queue (CRTOUTQ) command and Change Output Queue (CHGOUTQ) command.
- The SNDTCPSPLF command includes the TRANSFORM, MFRTYPMDL, and WSCST parameters.

The same WSCST object works for both the AFPDS to ASCII transform and the SCS to ASCII transform.

6.5 SCS to ASCII transform

The SNA Character String (SCS) data stream is a text-only data stream used for such items as job logs and general listings. The SCS to ASCII portion of the host print transform function provides 3812 SCS printer emulation. That means it supports page printer functions such as orientation and Computer Output Reduction (COR).

SCS to ASCII transform works by mapping commands in the SCS data stream to similar commands in the ASCII printer data stream. It does not support converting the data stream to an image the same way the AFP to ASCII transform does in raster mode.

Host print transform has the ability to process an IOCA image embedded in the SCS data stream. This is done by OfficeVision/400 with the graphic instruction. The target printer must be a laser printer supporting the PPDS or PCL data streams.

Note: The OV/400 graphic instruction allows you to embed an IOCA (image) or GOCA (graphic) object into the SCS data stream. Only IOCA objects are supported by the host print transform function.

Overlays referenced in the printer file, either for an application or for OfficeVision/400, are not supported by the SCS to ASCII transform.

Note: If the printer file device type is changed to *AFPDS, the spooled file created by the application is AFPDS. The overlays referenced in the printer file (front overlay and back overlay) will be handled by the AFP to PCL transform.

Almost all ASCII page printers have an unprintable border around the page where data cannot be printed. The SCS to ASCII transform function can compensate for the no-print borders. This is demonstrated in Figure 115.

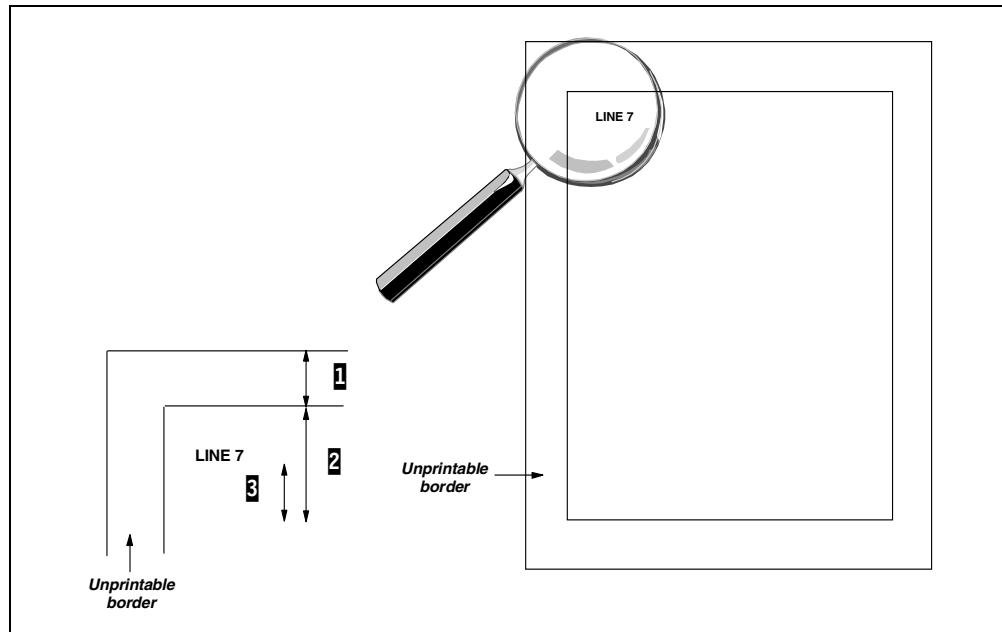

Figure 115. NOPRTBDR tag example

Notes

- 1** In this example, the top margin is ½ inch. This is the equivalent of three lines.
- 2** In the application, the first line prints at line 7, which means a skip of six lines, or one inch.
- 3** The top no-print border (NOPRTBDR) tag in the host print transform WSCST object is set to 720/1440 inch (½ inch). This value (equivalent to three lines) is a correction.

In this case, the NOPRTBDR value is equal to the top margin and will compensate for it. The first print line prints at line 7 as defined in the application.

This works the same for the other NOPRTBDR tags (bottom, left, and right). The value specified is always a correction.

Note: The no-print border values in the WSCST object cannot be used to position or format your output. Depending on the unprintable border size, no correction is possible if your print output starts at line 1, 2, or 3.

6.6 AFPDS to ASCII transform

AFPDS to ASCII transform supports AFPDS font, text, image, and barcode commands. It can convert the AFP data stream to a number of ASCII printer data streams, but the best or premier support is to the following ASCII printer data streams:

- PPDS levels 3 and 4 (IBM 4019 and 4029 laser printers)
- PCL 4, 5, and 6 (IBM Network Printers, IBM 4039 laser printer, HP LaserJet, HP InkJet (in raster mode only))

For other ASCII printer data streams, only the text of the AFP document is printed. Images and barcodes are not supported. If the printer does not support absolute movement, and the tags are not defined in the WSCST, the text is not positioned correctly. It is shown as one long string.

AFPDS resources (overlays, page segments, fonts) referenced in AFPDS spooled file are automatically converted and passed to the ASCII printer. See 6.6.3, “Processing AFP resources” on page 148, for more information.

The AFPDS to ASCII transform function was developed so that the transform always converts the AFP data stream to ASCII as well as possible. AFPDS functions that are not supported by the AFPDS to ASCII transform or cannot be converted to the ASCII printer data stream are ignored.

AFPDS to ASCII transform has two methods of performing the data stream conversion:

- **Mapping mode:** Map AFP commands to similar commands in the ASCII printer data stream. This method is available for all supported ASCII printer data streams.

- **Raster mode:** Builds a raster image of the page in AS/400 memory and prints the page as an image. This method is available for PPDS, pages, and PCL data streams.

Host print transform uses the mapping mode or the raster mode according to the printer data stream specified (PRTDTASTRM tag) in the Workstation Customizing object (WSCST object). To use raster mode, the PRTDTASTRM tag must be changed in the referenced WSCST object (for example, for a PCL5 printer from HPPCL5 (mapping mode) to HPPCL5I (raster mode)). See 6.8, “New and enhanced tags for WSCST objects” on page 152, for more information.

AFPDS to ASCII transform does not require PSF/400 to transform and print AFPDS spooled files on ASCII printers.

6.6.1 Mapping mode

Mapping mode maps AFPDS commands to similar commands in the ASCII printer data stream. This method is available for all supported ASCII printer data streams.

Mapping mode provides good performance, but is limited in function on the ASCII printer. For example, you cannot print 270 degree orientation to a printer that only supports 0 and 90 degree orientations.

Using mapping mode, the AFPDS to ASCII transform can convert and download AFP host resident fonts to PPDS and PCL printers. This provides font fidelity to these printers. For other ASCII data streams, only printer resident fonts can be used with mapping mode.

Mapping mode: Processing AFP fonts

In AFP documents, fonts and code pages can be specified as printer-resident or host-resident. Printer-resident fonts are specified by a Font Global ID (FGID), and printer-resident code pages are specified by a Code Page ID (CPID). Host-resident fonts are specified by a font character set name, and host-resident code pages are specified by a code page name. When mapping AFP fonts to ASCII fonts, the AFPDS to ASCII transform allows the user to use fonts resident on their ASCII printer or download host-resident fonts to PCL and PPDS printers.

The AFPDS transform can use either the 240-pel or 300-pel version of a host-resident font. For the best results, the 300-pel version should be used. With 240-pel fonts, the character images are scaled to 300-pel. This may cause the edges of the characters to be jagged or fuzzy. Font character sets exist in the 240 pel version in the Font Compatibility Set shipped with OS/400 (library QFNTCPL in QSYS). We recommend using 300-pel fonts from the IBM Font Collection for IBM Operating Systems (5648-113).

When downloading host-resident fonts to an ASCII printer, the fonts are cleared from the printer's memory at the end of the document. The host print transform function assumes the ASCII printer is a shared device, and there is no way to know what other applications will do to the printer.

When an AFP document calls for a printer-resident font and code page (FGID/CPID), the AFPDS to ASCII transform performs the following steps to select a font when the transform is in mapping mode:

1. Check the WSCST object to see if these values (FGID/CPID) are defined. If they are, the printer commands from the WSCST are sent to the printer to set the font and code page.
2. If the FGID is not defined in the WSCST object, an internal table in the code lists the commonly used FGIDs and their attributes. This helps in generating the ASCII printer commands to select the font.

The following legend applies to the information shown in Table 13.

- **U** = Uniformly spaced
- **M** = Mixed pitch
- **T** = Typographic
- **i** = Italic
- **b** = Bold
- **w** = Double Wide

Table 13. Commonly used FGIDs table

FGID	Name	Type of font	Attribute	Point	Pitch
5	Orator	U			10
11	Courier	U			10
12	Prestige	U			10
18	Courier	U	i		10
38	Orator	U	b		10
39	Gothic	U	b		10
40	Gothic	U			10
46	Courier	U	b		10
66	Gothic	U			12
68	Gothic	U	i		12
69	Gothic	U	b		12
85	Courier	U			12
86	Prestige	u			12
87	Letter Gothic	U			12
92	Courier	U	i		12
110	Letter Gothic	U	b		12
111	Prestige	U	b		12
112	Prestige	U	i		12
160	Essay	M			12
162	Essay	M	i		12
164	Prestige	M			12
173	Essay	M			12
204	Matrix Gothic	U			13

FGID	Name	Type of font	Attribute	Point	Pitch
221	Prestige	U			15
223	Courier	U			15
230	Gothic	U			15
244	Courier	U	w		5
245	Courier	U	b,w		5
252	Courier	U			17
253	Courier	U	b		17
254	Courier	U			17
256	Prestige	U			17
281	Gothic Text	U			20
290	Gothic Text	U			27
751	Sonoran Serif	T		8	27*
760	Times	T		6	36*
761	Times	T	b	12	18*
762	Times	T	b	10	15*
763	Times	T	i	12	18*
764	Times	T	b,i	10	21*
765	Times	T	b,i	12	18*
1051	Sonoran Serif	T		10	21*
1056	Sonoran Serif	T	i	10	21*
1351	Sonoran Serif	T		12	18*
1653	Sonoran Serif	T	b	16	13*
1803	Sonoran Serif	T	b	18	12*
2103	Sonoran Serif	T	b	24	9*
* The pitch column for typographic fonts indicates the width of the space character between the printed characters.					

If the FGID is not in the table and the ASCII data stream is PPDS or PCL, the transform sends the font request to the printer and lets it perform a best fit match. This is similar to what the SCS to ASCII transform does today.

3. In all other cases, the font request is ignored, and printing continues in the current font.

When an AFP document calls for a host-resident code page and font character set, the AFPDS transform performs the following steps to select a font:

1. If the ASCII data stream is PPDS or PCL, the transform obtains the font resource and converts it to the proper format for printing.

2. If the ASCII data stream is not PPDS or PCL, the transform ignores the font request. Printing continues in the current font.

6.6.2 Raster mode

Raster mode builds a raster image of the page in AS/400 memory and then sends the image to the printer. This method is available for PPDS, Pages, and PCL data streams. This method is slower than mapping mode, but allows:

- Support of ink jet printers that require the page to be printed in order (only one pass of the page). Normally, AFP documents make multiple passes of the page (for example, an overlay is printed before the text is printed).
- Font fidelity for printers to which the transform cannot download fonts.
- Support of AFPDS functions not available on ASCII printers, such as multiple page orientations to a 4019 printer.

Raster mode: Processing AFP fonts

In AFP documents, fonts and code pages can be specified as printer-resident or host-resident. Printer-resident fonts are specified by a Font Global ID (FGID), and printer-resident code pages are specified by a Code Page ID (CPID). Host-resident fonts are specified by a font character set name, and host-resident code pages are specified by a code page name. In raster mode, only host-resident fonts can be used.

The AFPDS transform can use either the 240-pel or 300-pel version of a host-resident font. For the best results, the 300-pel version should be used. With 240-pel fonts, the character images are scaled to 300 pel. This may cause the edges of the characters to be jagged or fuzzy. Font character sets exist in the 240-pel version in the Font Compatibility Set shipped with OS/400 (library QFNTCPL in QSYS). We recommend using 300-pel fonts from the IBM Font Collection for IBM Operating Systems (5648-113).

When an AFP document calls for a printer-resident code page and font (CPID/FGID), the AFPDS to ASCII transform performs the following steps to select a font if the transform is in raster mode:

1. The transform looks in the spooled file library list and font libraries QFNTCPL and QFNTxx for a host-resident character set and code page. The code page name to look for is determined by converting the CPID to a four-character string and appending it to the prefix "T1V1".

The font character set name to look for is determined by looking at Table 14.

Table 14. Font substitution table 2

FGID range	Substituted font character set name
Fonts 1 through 17	C0S0CR10
Font 18	C0S0CI10
Fonts 19 through 38	C0S0CR10
Font 39	C0D0GB10
Font 40	C0D0GT10
Fonts 41 through 45	C0S0CR10

FGID range		Substituted font character set name
Font 46		C0S0CB10
Fonts 47 through 65		C0S0CR10
Fonts 66 through 68		C0D0GT12
Font 69		C0D0GB12
Fonts 70 through 91		C0S0CR12
Font 92		C0S0CI10
Fonts 93 through 109		C0S0CR12
Fonts 110 through 111		C0S0CB12
Fonts 112 through 153		C0S0CR12
Fonts 154 through 161		C0S0ESTR
Font 162		C0S0EITR
Fonts 163 through 200		C0S0ESTR
Fonts 201 through 210		C0D0GT13
Fonts 211 through 229		C0S0CR15
Font 230		C0D0GT15
Fonts 231 through 239		C0S0CR15
Fonts 240 through 246		C0S0CR10
Fonts 247 through 259		C0D0GT18
Fonts 260 through 273		C0S0CB10
Fonts 274 through 279		C0D0GT18
Fonts 280 through 289		C0D0GT20
Fonts 290 through 299		C0D0GT24
Fonts 300 through 2303		C0D0GT18
Fonts 2304 through 3839 or 4098 through 65279	Fonts with point size 0 through 7.5	C0D0GT18
	Fonts with point size 7.6 through 9.5	C0S0CR15
	Fonts with point size 9.6 through 11.5	C0S0CR12
	Fonts with point size 11.6 through 13.5	C0S0CR10
	Fonts with point size 13.6 and greater	C0S0CB10
Fonts 3840 through 4095 (User-defined)		No substitution
Fonts 65280 through 65534 (User-defined)		No substitution

If code page 259 (Symbols) is specified, Table 14 is not used. In this case, character set C0S0SYM2 is used for fonts 0 to 65. For all other fonts, character set C0S0SYM0 is used.

All of the preceding character sets exist in 240-pel versions in the font compatibility set that is shipped with OS/400 (Library QFNTCPL in QSYS) or, for best results, in 300-pel versions in the IBM Font Collection for IBM Operating Systems (5648-113).

2. If the correct host-resident font cannot be found, the transform ignores the font request and printing continues in the current font. If this is the first font request of the document, the transform ends with an error.

When an AFP document calls for a host-resident font character set and code page, the AFPDS transform gets the font character set and converts it to the proper format for printing. Font bitmaps are moved into the raster image of the page.

6.6.3 Processing AFP resources

AFPDS to ASCII transform uses the new List Spooled File AFPDS Resources (QGSLRSC) and Copy AFPDS Resource (QGSCPYRS) APIs to process external resources such as character sets, overlays, and page segments.

For font character sets, the AFPDS to ASCII transform always calls the List Spooled File AFPDS Resources API for the 300-pel version. If the resource cannot be found on the system, the AFPDS to ASCII transform calls the API a second time for the 240-pel version.

Overlays and page segments are converted. Support for IO1 images (IOCA) and IM1 images (raster) referenced in page segments is included. Fonts referenced in overlays are processed according to the mode selected.

AFP resources are cleared from the printer's memory at the end of the document. The host print transform function assumes the ASCII printer is a shared device, and there is no way to know what other applications will do to the printer.

6.6.4 Processing AFPDS barcodes

A barcode is a predetermined pattern of bars and spaces that represent numeric or alphanumeric information in a machine readable form. Barcodes are commonly used in many applications including item tracking, inventory control, point-of-sale operations, and patient care.

The IBM Advanced Function Print (AFP) data stream defines an architecture for presenting barcodes. The following industry barcode standards are supported by the AFPDS to ASCII transform function:

- Code 39, AIM USS-39
- MSI
- UPC/CGPC Version A
- UPC/CGPC Version E
- UPC Two-digit Supplemental
- UPC Five-digit Supplemental
- EAN-8
- EAN-13
- Industrial 2-of-5
- Matrix 2-of-5
- Interleaved 2-of-5, AIM USS-1 2/5
- Codabar 2-of-7, AIM USS-Codabar

- Code 128, AIM USS-128
- EAN Two-digit Supplemental
- EAN Five-digit Supplemental
- POSTNET
- Japan Postal (New V4R2)
- Royal Mail (New V4R2)

Note: UCC/EAN-128 is supported by host print transform. UCC/EAN-128 is a standard that consists of both a barcode standard and a defined data structure. The barcode used is a subset of Code 128. More information about the Uniform Code Council and UCC/EAN-128 can be found at: <http://www.uc-council.org/>

Barcode support is available for PCL and PPDS data streams in mapping mode or in raster mode. In mapping mode, barcodes are implemented in the AFPDS to ASCII transform as downloaded fonts.

In addition to the barcode symbol, the barcode data stream can also request that human readable interpretation (HRI) be printed. The following fonts are required to print the barcode HRI:

- OCR-A
- OCR-B for UPC barcodes
- Device default, Gothic Roman 10 point

OCR-A, OCR-B, and Gothic Roman 10 point are available in the 240-pel compatibility fonts (library QFNTCPL in QSYS).

Note: For best results, we recommend that you use outline fonts or 300-pel fonts from the IBM AFP Font Collection (5648-B45).

6.6.5 How AFPDS to ASCII transform handles a no-print border

Absolute movement is done with reference to the origin of the page. The AFP data stream expects the origin to be the upper left corner of the physical page. Most ASCII laser printers have a no-print border, and their origin is in the upper left corner of the printable area.

AFPDS to ASCII transform uses the current no-print border values from the workstation customizing object to determine the position of the origin on the ASCII printer.

In mapping mode, the AFPDS to ASCII transform adjusts cursor movement within the printable area of the page so it appears that the origin is in the upper left corner of the physical page (what an AFP data stream expects). Cursor movements within the no-print border are moved to the edge of the no-print border. AFP positions past the top and left no-print border values are reduced by no-print border values to print at the correct paper location.

Note: No-print border problems in mapping mode can be corrected by changing to raster mode or removing the no-print border values from WSCST.

For raster mode, the page is turned into an image and the first row and column that contains a black pel is known. If that row or column is in the no-print border, the entire image is shifted to preserve the top and left edges. This may result in data being clipped from the right and bottom edges.

6.6.6 AFPDS to TIFF

Host print transform can also transform an AFPDS data stream to TIFF. The data stream tag (PRTDTASTRM) in the WSCST object is used to determine the type of transform:

- TIFF Packbit format if PRTDTASTRM tag set to TIFF_PB
- TIFF G4 format if PRTDTASTRM tag set to TIFF_G4

AFPDS to TIFF transform works the same as the AFPDS to ASCII transform in raster mode. The following source is the full WSCST source needed to transform AFPDS to the TIFF Packbit format:

```
:WSCST DEVCLASS=TRANSFORM.  
      :TRNSFRMTBL.  
      :PRTDTASTRM  
      DATASTREAM=TIFF_PB.  
      :INITPRT  
      DATA ='4D4D002A'X.  
      :RESETPRT  
      DATA ='00000000'X.  
      :EWSCST.
```

To create the WSCST object for the AFPDS to TIFF transform, copy the preceding source into a source file member and use the CRTWSCST command to create and compile the object.

Note: WSCST objects QWPTIFFPB and QWPTIFFG4 are available in library QSYS on V3R2 and V3R7 and later. Since this is not used for printing, there is no manufacturer type and model added for it.

For example, an application program can now use the host print transform API to convert an AFPDS spooled file to a TIFF image and then present the image on an IBM 3489 InfoWindow II display.

6.6.7 Transform spooled file and write to folder

A program sample for retrieving data from a spooled file, transforming it through host print transform, and writing the output to a folder is available from the IBM Redbooks Web site. This type of program can be used to transform output data (for example, AFP pages to TIFF images) from an AS/4000 output queue to a folder to be accessible to a browser. The sample code can be found at:

<http://www.redbooks.ibm.com>

On the redbooks home page, click **Additional Materials**. Click **here** for the directory listing. On the list that is displayed, search for the directory **SG242160**. Using FTP, you can download the command (HPTTOFLR.COMD) and the source code of the program (HPTTOFLR.C) from this directory.

For the transformation, this program allows you to use any of the available Work Station Customizing (WSCST) objects. For creating output in TIFF, use the WSCST example in 6.6.6, "AFPDS to TIFF" on page 150.

6.6.8 AFPDS to ASCII transform limitations

The following list describes the limitations of AFP to ASCII transform. This list is not prioritized.

- Dot matrix ASCII printers are not supported. Since these printers do not support absolute movement, even text does not print correctly. Text prints as one long string.
- The transform does not support AFP graphics (GOCA) commands. For example, pie charts generated by BGU or GDF files imbedded in the spooled file will not print.
- The transform ignores the fidelity attribute of the spooled file and always performs content printing.
- The transform does not support COR and multi-up printing.
- The transform does not support color barcodes.
- At this time, the transform can only produce 240 or 300 dpi images.

6.7 Host print transform customization

If you do not find your printer in the list of the manufacturer type and model (MFRTYPMDL) special values, or if you need additional print functions, you can specify a workstation customized (WSCST) object instead of a MFRTYPMDL special value.

Before you can begin customizing an ASCII printer, you must have information on the functions that the ASCII printer supports. You can only add or change printing functions that a printer supports. You also need the hexadecimal values for these functions. Often, the technical reference manual for the printer provides this information.

The source of a WSCST object is a tag language. Tags can contain information for host print transform, hard-coded printer commands, or printer commands with replacement parameters (variables). Figure 116 shows an example of the WSCST source and the three tag types.

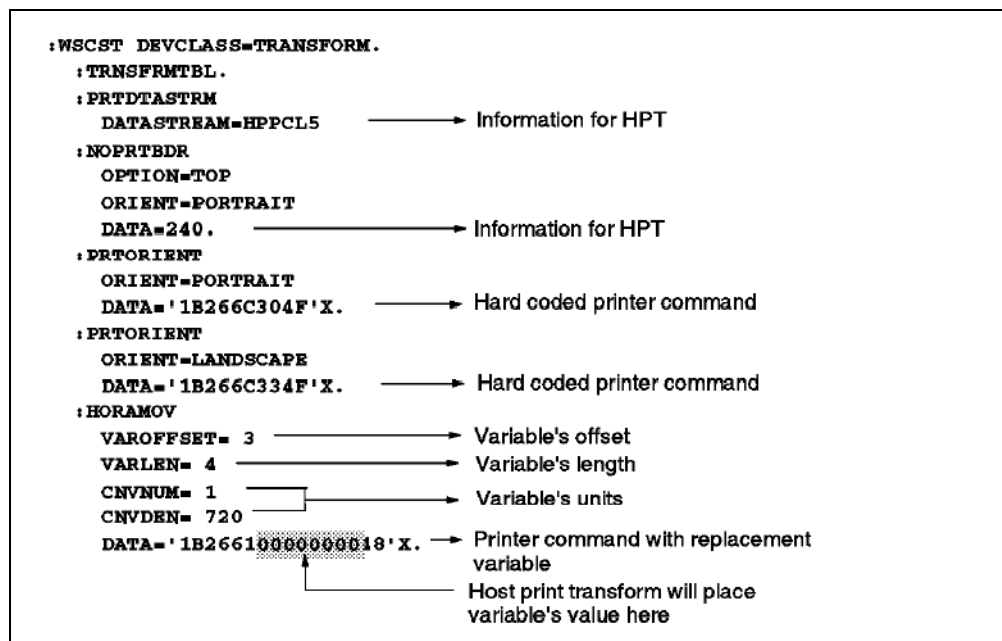

Figure 116. WSCST source and tag types

Use the following steps to customize the functional characteristics of an ASCII printer:

1. Use the `RTVWSCST` command to retrieve an existing WSCST object into a source physical file.
2. Use `SEU` or the `STRPDM` command to update or change the WSCST source file.
3. Use the `CRTWSCST` command to compile or create a customized WSCST object.
4. Specify `*WSCST` as the `MFRTYPMDL` value in the printer device description, in the `CRTOUTQ/CHGOUTQ` if you are using remote system printing, or in the `SNDTCPSPLF` command.
5. Specify the name of your WSCST object in the `WSCST` parameter in the device description, in the `CRTOUTQ/CHGOUTQ` if you are using remote system printing, or in the `SNDTCPSPLF` command.

Customizing an ASCII printer may involve a trial-and-error process. The amount of time required to customize a printer depends on the type of printer, regardless of whether the printer is already supported by the AS/400 system, and the completeness of the manual for the printer. Plan anywhere from one to five days to complete a successful ASCII printer customization.

For detailed information on customizing a WSCST object, see *AS/400 Printing IV*, GG24-4389. The “Advanced host print transform customization” chapter contains an example and a description of the different tags. The manual *AS/400 Workstation Customization Programming*, SC41-3605, also contains a description of all the tags.

6.8 New and enhanced tags for WSCST objects

The following list describes the new and changed tags for the host print transform WSCST objects:

- **PRTDTASTRM** (Printer Data Stream):

The `PRTDTASTRM` tag defines the data stream of the ASCII printer. This tag is currently defined, but the following data stream values are added:

- **IBMPPDS3:**

The IBM personal printer data stream level 3 is supported. This is used for the IBM 4019 printer. Supported functions over level 2 are page rotation and non-compressed image.

- **IBMPPDS4:**

The IBM personal printer data stream level 4 is supported. This is used for the IBM 4029 printer. Supported functions over level 3 are multiple rotations on a page and compressed image.

- **IBMPPDS3I:**

The IBM personal printer data stream level 3 is supported in raster mode. This value means the same to SCS to ASCII transform as `IBMPPDS3` since it only supports the mapping mode. For AFP to ASCII transform, this value causes it to go into raster mode for a PPDS level 3 (4019) printer.

– **IBMPPDS4I:**

The IBM personal printer data stream level 4 is supported in raster mode. This value means the same to SCS to ASCII transform as IBMPPDS4 since it only supports the mapping mode. For AFP to ASCII transform, this value causes it to go into raster mode for a PPDS level 4 (4029) printer.

– **HPPCL4I:**

The Hewlett Packard PCL4 printer data stream is supported in raster mode. This value means the same to SCS to ASCII transform as HPPCL4 since it only supports the mapping mode. For AFP to ASCII transform, this value causes it to go into raster mode for a PCL4 printer.

– **HPPCL5I:**

The Hewlett Packard PCL5 printer data stream is supported in raster mode. This value means the same to SCS to ASCII transform as HPPCL5 since it only supports the mapping mode. For AFP to ASCII transform, this value causes it to go into raster mode for a PCL5 printer.

– **TIFF_PB:**

This value is used for AFPDS to TIFF format transform. With this value, the image is generated in TIFF Packbit format.

– **TIFF_G4:**

This value is used for AFPDS to TIFF format transform. With this value, the image is generated in TIFF G4 format.

– **IOCA_G3MH** (V3R7 and later):

To support fax when the IBM 7852-400 modem is used as a fax controller.

– **IOCA_G3MRK2** (V3R7 and later):

To support fax when the IBM 7852-400 modem is used as a fax controller.

– **IOCA_G3MRK4** (V3R7 and later):

To support fax when the IBM 7852-400 modem is used as a fax controller.

• **HORAMOV** (Horizontal Absolute Move):

The HORAMOV tag adjusts the print position in the current line according to the value given in the command. The format of the tag is:

```
:HORAMOV
  VAROFFSET = variable offset in control sequence
  VARLEN = variable length
  VARTYPE = HIGHLOW|LOWHIGH|CHRDEC|CHRHEX|CHRAN
  CNVNUM = conversion ratio numerator
  CNVDEN = conversion ratio denominator
  DATA = ASCII control sequence.
```

• **VERAMOV** (Vertical Absolute Move):

The VERAMOV tag adjusts the print position in the current column according to the value given in the command. The format of the tag is:

```
:VERAMOV
  VAROFFSET = variable offset in control sequence
  VARLEN = variable length
  VARTYPE = HIGHLOW|LOWHIGH|CHRDEC|CHRHEX|CHRAN
  CNVNUM = conversion ratio numerator
```

CNVDEN = conversion ratio denominator
DATA = ASCII control sequence.

- **RASEND** (Raster Graphics End):

Marks the end of a raster graphics image. The format of the tag is:

```
:RASEND  
ASCII control sequence.
```

- **TOPMARGINI** (Set Top Margin in Inches):

Sets the top of the page in inches. The format of the tag is:

```
:TOPMARGINI  
VAROFFSET = variable offset in control sequence  
VARLEN = variable length  
VARTYPE = HIGHLOW|LOWHIGH|CHRDEC|CHRHEX|CHRAN  
CNVNUM = conversion ratio numerator  
CNVDEN = conversion ratio denominator  
DATA = ASCII control sequence.
```

- **TEXTLENL** (Set Text Length):

Sets the length or bottom margin of the page. The format of the tag is:

```
:TEXTLENL  
VAROFFSET = variable offset in control sequence  
VARLEN = variable length  
VARTYPE = HIGHLOW|LOWHIGH|CHRDEC|CHRHEX|CHRAN  
DATA = ASCII control sequence.
```

- **PRTNXTCHR** (Print Next Character):

Causes the printer to treat the next code point as a graphic character. The format of the tag is:

```
:PRTNXTCHR  
DATA = ASCII control sequence.
```

- **PRTANGLE** (Print Angle):

Changes the direction of future printing on the page. This allows printing in all four directions on the same page. The format of the tag is:

```
:PRTANGLE  
ANGLE = 0 | 90 | 180 | 270  
DATA = ASCII control sequence.
```

6.9 New MFRTYPMDL special values

These new manufacturer type and model (MFRTYPMDL) special values provide default paper sizes. You can use them when no device description exists for the target printer (for example, when the printer is attached using TCP/IP LPR-LPD and a remote output queue is used).

Note: When a device description exists for the target printer, the default paper sizes are specified in the device description.

These new MFRTYPMDL special values are available with Version 3.0 Release 2.0 and Version 3.0 Release 7.0 and later:

***WSCSTLETTER** Set Letter format
***WSCSTLEGAL** Set Legal format

- *WSCSTEXECUTIVE** Set Executive format
- *WSCSTA3** Set A3 format
- *WSCSTA4** Set A4 format
- *WSCSTA5** Set A5 format
- *WSCSTB4** Set B4 format
- *WSCSTB5** Set B5 format
- *WSCSTCONT80** Set continuous form 80 characters
- *WSCSTCONT132** Set continuous form 132 characters
- *WSCSTNONE** Paper size not specified (no *Set paper size* command in the data stream)

If you have a printer device description, you must also specify **NONE* for the default paper size parameters. If you don't, the value from the paper size parameters will override the value of the WSCST object.

Note: If no paper size is specified, no COR will occur. It can be used to disable the COR function. To use these new WSCST objects, complete the following steps:

1. Retrieve the workstation customized object, for example:

```
RTVWSCST DEVTYPE(*TRANSFORM) MFRTYPMDL(*IBM4317) SRCMBR(NP17SRC)
SRCFILE(QGPL/QTXTSRC)
```

2. Create a customized workstation configuration object:

```
CRTWSCST WSCST(QGPL/NP4317) SRCMBR(NP17SRC)
```

You will receive the message "Customization object NP4317 created successfully".

3. Stop the remote writer:

```
ENDWTR WTR(outputq_name) OPTION(*IMMED)
```

4. To change the output queue, enter the `CHGOUTQ` command, and press the F4 (Prompt) function key. Then page down until you see the parameters shown in Figure 117.

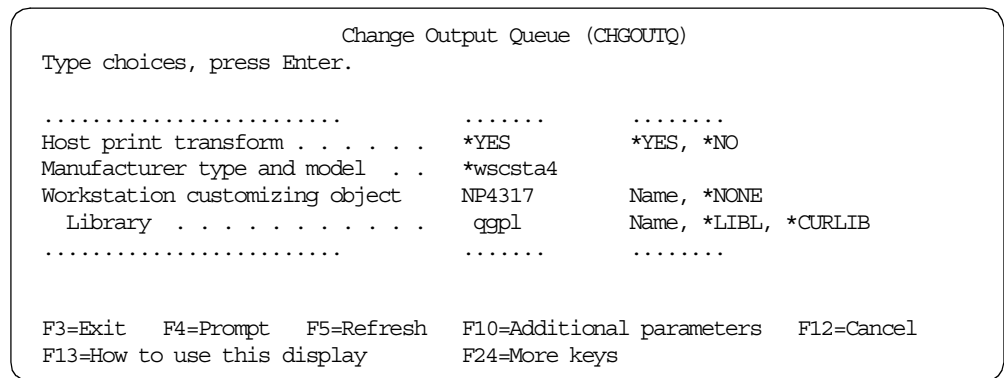

Figure 117. Change Output Queue: HPT and WSCST parameter

On this display, enter the following parameter values:

- **Manufacturer type and model:** *WSCSTA4 (or any from the other formats)
- **Workstation customizing object:** NP4317 (the object that you created with the command CRTWSCST)

- **Library:** QGPL (the library specified in the CRTWSCST command)
5. Press Enter to modify your output queue.

6.10 DBCS support in host print transform

In August 1996, host print transform was enhanced through a number of V3R2 PTFs to support double-byte character set (DBCS) printing. These enhancements can also be found in the base of the V3R7 and later versions and releases.

These enhancements allow DBCS printing to ASCII printers through the Send TCP Spooled file (LPR) command or the remote system printing and ASCII LAN attached printer option where host print transform is the only transform option. They can also be used in place of the transform found on PC and terminal emulators, but only if they emulate a 3812 printer.

6.10.1 DBCS SCS to ASCII transform

The host print transform uses AS/400 ICONV support to convert EBCDIC data to ASCII data.

6.10.1.1 DBCS EBCDIC to ASCII transform

FROM to CCSID mapping tables provide the mapping of CCSIDs to convert a double-byte EBCDIC character in an application data stream into an ASCII character code value (for that same character).

The workstation customizing object provides new tags to identify the FROM(EBCDIC) CCSID and the TO (ASCII) CCSID. If no tag is specified in the workstation customizing object, the FROM-TO assignment is made according to the information in Table 15.

Table 15. Default from or to the CCSID table

From CCSID	Default CCSID	Language
5026	932	Japanese
5035	932	Japanese
930	932	Japanese
931	932	Japanese
939	932	Japanese
933	949	Korean
937	959	Traditional Chinese
935	1381	Simplified Chinese

6.10.1.2 New WSCST objects for DBCS

The DBCS WSCST objects and their corresponding manufacturer type and model (MFRTYPMDL) special values shown in Table 16 were added as part of this enhancement for SCS to ASCII transform.

Table 16. DBCS WSCST objects and corresponding MFRTYPMDL

WSCST	MFRTYPMDL	Description
QWPESCP	*ESCPDBCS	Epson ESC/P DBCS printers
QWPIBM2414	*IBM5575	IBM Non-Pages PS/55 printers
QWPPAGES	*IBMPAGES	IBM Pages PS/55 printers
QWPNEC201	*NECPCPR201	NEC PC-PR101/201 printers
QWPLIPS3	*CANLIPS3	Canon LIPS# printers

6.10.2 DBCS AFPDS to ASCII transform

Host print transform processes DBCS AFP print jobs in raster mode only. For more information on the raster mode, see 6.6.2, “Raster mode” on page 146. That is, a raster image of each page is created in AS/400 memory and sent to the printer. The ASCII printer must accept raster images to work with the AFPDS to ASCII transform.

The main change to the AFPDS to ASCII transform is the support of DBCS fonts. The host print transform requires the DBCS fonts selected in a DBCS AFP print job to be loaded on the AS/400 system. DBCS fonts that reside on the ASCII printer are not used to process DBCS print jobs.

Host print transform has also been enhanced to support a character rotation of 270 degrees. DBCS languages use a character rotation of 270 degrees to implement right-to-left, top-to-bottom printing.

6.10.3 New tags and supported data streams for DBCS

The following new tags are added for the Host Print Transform workstation customizing objects:

- **EBCASCCSID** (EBCDIC-to-ASCII CCSID mapping):

Use the EBCACCSID tag to begin a group of one or more EBCASCCSIDE tags. This tag must be followed by one or more CCSID mapping entries. There are no parameters on this tag. The syntax for this tag is:

```
:EBCASCCSID.
```

- **EBCASCCSIDE** (EBCDIC-to-ASCII CCSID mapping entry):

This new tag defines the mapping of double-byte EBCDIC CCSIDs to their ASCII CCSID. The EBCASCCSIDE tag must follow an EBCASCCSID tag. The syntax of this tag is:

```
:EBCASCCSIDE  
  EBCDICCSID = EBCDIC CCSID (integer)  
  ASCII CCSID = ASCII CCSID (integer).
```

EBCDICCSID is a required parameter. It defines the EBCDIC CCSID identifier. The CCSID is a registered EBCDIC identifier used to specify the CCSID of the source characters.

ASCII CCSID is a required parameter. It defines the ASCII CCSID identifier. The CCSID is a registered ASCII identifier used to specify the CCSID of the target characters.

- **EEBCASCCSID** (End EBCDIC-to-ASCII CCSID mapping table entry):

Use the EEBCASCCSID tag to end the EBCDIC-to-ASCII CCSID mapping customization. The syntax for this tag is:

```
:EEBCASCCSID.
```

- **PRTALLCHR** (Print All Characters):

This command causes the printer to interpret the bytes that follow as printable characters rather than control codes. Note that the PRTNXTCHR provides the same function, but only for one byte. The syntax of this tag is:

```
:PRTALLCHR  
  VAROFFSET = variable offset in control sequence  
  VARLEN = variable length  
  VARTYPE = HIGHLOW|LOWHIGH|CHRDEC|CHRHEX|CHRAN  
  DATA = ASCII control sequence.
```

- **SI** (Shift IN):

This command causes the printer to interpret the bytes that follow as SBCS characters. The syntax of this tag is:

```
:SI  
  DATA = ASCII control sequence.
```

- **SO** (Shift OUT):

This command causes the printer to interpret the bytes that follow as DBCS characters. The syntax of this tag is:

```
:SO  
  DATA = ASCII control sequence.
```

- **DBSPACE** (DBCS Space):

The DBSPACE tag defines the ASCII control sequence for the double-byte space control function for an ASCII printer. The syntax of this tag is:

```
:DBSPACE  
  DATA = ASCII control sequence.
```

- **CHRORIENT** (Character Orientation):

The CHRORIENT tag defines the control sequence for setting different character orientations. The syntax of this tag is:

```
:CHRORIENT  
  ORIENT = PORTRAIT|LANDSCAPE|RTT180|RTT270  
  DATA = ASCII control sequence.
```

- **SCPITCH** (Set Character Pitch):

The SCPITCH tag defines the control sequence for setting the number of characters per inch. The syntax of this tag is:

```
:SCPITCH  
  VAROFFSET = variable offset in control sequence  
  VARLEN = variable length  
  VARTYPE = HIGHLOW|LOWHIGH|CHRDEC|CHRHEX|CHRAN  
  CNVNUM = conversion ratio numerator
```

CNVDEN = conversion ratio denominator
DATA = ASCII control sequence.

- **SLPITCH (Set Line Pitch):**

The SLPITCH tag defines the control sequence for setting the number of lines per inch. The syntax of this tag is:

```
:SLPITCH
  VAROFFSET = variable offset in control sequence
  VARLEN = variable length
  VARTYPE = HIGHLOW|LOWHIGH|CHRDEC|CHRHEX|CHRAN
  CNVNUM = conversion ratio numerator
  CNVDEN = conversion ratio denominator
  DATA = ASCII control sequence.
```

- **FONTSCALING (Set Font Size Scaling):**

The FONTSCALING tag defines the control sequence for setting the font size scaling. The syntax of this tag is:

```
:FONTSCALING
  VAROFFSET = variable offset in control sequence
  VARLEN = variable length
  VARTYPE = HIGHLOW|LOWHIGH|CHRDEC|CHRHEX|CHRAN
  CNVNUM = conversion ratio numerator
  CNVDEN = conversion ratio denominator
  DATA = ASCII control sequence.
```

- **FONTSCALE (Set Font Size Scale):**

The FONTSCALE tag defines the control sequence for setting the font size scaling. The syntax of this tag is:

```
:FONTSCALE
  SCALE = 1VX1H | 2VX1H | 1VX2H | 2VX2H
  DATA = ASCII control sequence.
```

- **CPI (Set Characters per Inch):**

The CPI tag defines the control sequence for setting the number of characters per inch. New values for 6, 6.7, 7.5, and 18 cpi are added to this tag. The syntax of this tag is:

```
:CPI
  CPI = 5|6|6.7|7.5|10|12|13.3|15|16.6|17.1|18|20|25|27
  DATA = ASCII control sequence.
```

- **GLTYPE (Set Grid Line Width):**

The GLTYPE tag defines the control sequence for setting the grid line type. The syntax of this tag is:

```
:GLTYPE
  VAROFFSET = variable offset in control sequence
  VARLEN = variable length
  VARTYPE = HIGHLOW|LOWHIGH|CHRDEC|CHRHEX|CHRN
  DATA = ASCII control sequence.
```

- **GLWIDTH (Set Grid Line Type):**

The GLWIDTH tag defines the control sequence for setting the grid line width. The syntax of this tag is:

```
:GLTYPE
  VAROFFSET = variable offset in control sequence
```

VARLEN = variable length
VARTYPE = HIGHLOW|LOWHIGH|CHRDEC|CHRHEX|CHRAN
DATA = ASCII control sequence.

- **DRAWLINE** (Draw Grid Line):

The DRAWLINE tag defines the control sequence for the draw grid line function. The syntax of this tag is:

```
:DRAWLINE  
  VAROFFSET = variable offset in control sequence  
  VARLEN = variable length  
  VARTYPE = HIGHLOW|LOWHIGH|CHRDEC|CHRHEX|CHRAN  
  CNVNUM = conversion ratio numerator  
  CNVDEN = conversion ratio denominator  
  DATA = ASCII control sequence.
```

To support the new DBCS printers, new data stream values are available to the PRTDTASTRM tag. These new values are:

- **IBMNONPAGES**: The IBM DBCS Non-Pages (dot matrix printers) data stream is supported.
- **IBMPAGES**: The IBM DBCS Pages data stream is supported.
- **ESC/P**: The Epson DBCS ESC/P data stream is supported.
- **LIPS2+**: The Canon DBCS LIPS2+ data stream is supported.
- **LIPS3**: The Canon DBCS LIPS3 data stream is supported.

Chapter 7. Image print transform

This chapter provides information about the image print transform function available with Version 4.0 Release 2.0, and describes how to enable it to provide additional support for printers that are attached to the AS/400 system. The image print transform function is an OS/400 function that is capable of converting image or PostScript data streams into AFPDS or ASCII printer data streams. The conversion takes place on the AS/400 system, which means the data stream generated is independent of any printer emulators or hardware connections.

7.1 Image print transform function

The image print transform function (Figure 118) converts image or print data from one format into another. The resultant data stream is a printer data stream. Therefore, it is capable of being interpreted by a supporting printer.

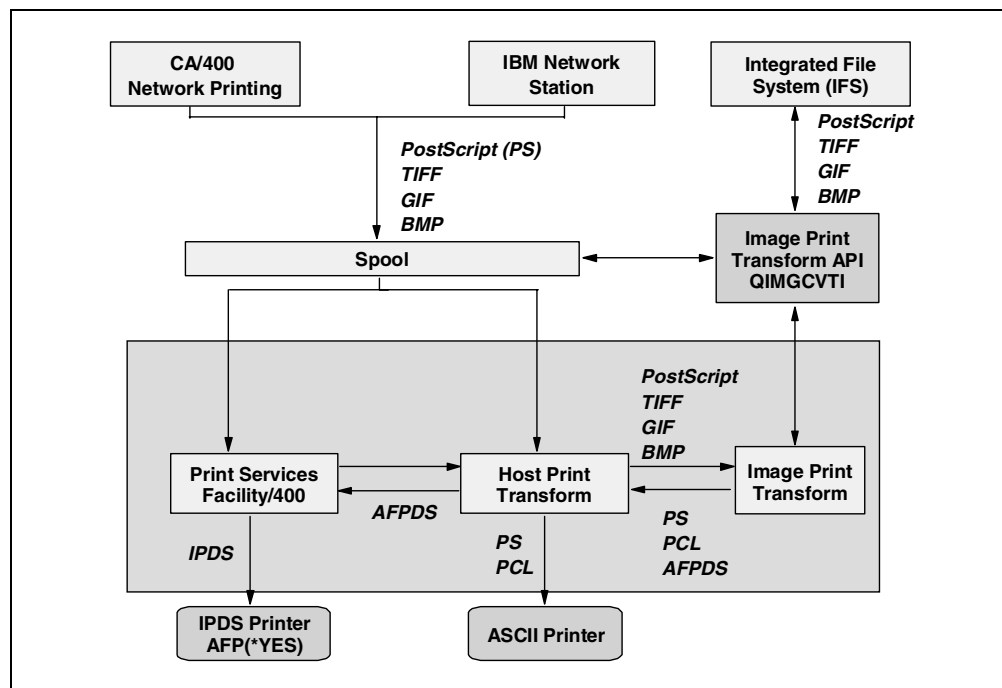

Figure 118. Image print transform function

The image print transform function can convert the following data streams:

- Tag Image File Format (TIFF)
- Graphics Interchange Format (GIF)
- OS/2 and Windows Bitmap (BMP)
- PostScript Level 1

The image print transform function can generate the following data streams:

- Advanced Function Printing Data Stream (AFPDS)
- Hewlett-Packard Printer Control Language (PCL)
- PostScript Level 1

Similar to the host print transform function, the image print transform function converts the data on the AS/400 system instead of using an emulator.

When a data stream is converted by the image print transform function, the printer data stream that is created contains a bit-mapped image. A bit-mapped image is an array of numeric values. Each value represents part or all of a pixel. A pixel is a single point or dot of an image.

An image is usually measured in terms of pixels for both width and height. The resolution of an image is then defined as the number of pixels (dots) per unit of measure. For example, a resolution supported by many printers is 300 dots per inch (dpi). Therefore, an image having dimensions of 1200 pixels by 1500 pixels has a width of 4 inches and a height of 5 inches when it is printed at 300 dpi.

7.2 Why use image print transform

There are many advantages for using the image print transform function.

- Support for Intelligent Printer Data Stream (IPDS) printers:

TIFF, GIF, and BMP image files, as well as PostScript Level 1 files, can be converted to AFPDS format and printed on IPDS printers configured AFP(*YES).

- Support for ASCII printers:

TIFF, GIF, and BMP image files, as well as PostScript Level 1 files, can be converted to PCL-5 and PostScript Level 1 format and printed on ASCII printers supporting these standards.

Note: You cannot convert from one type of PostScript to another using the image print transform function. When the input and output data streams are PostScript, the data is sent directly to the output destination without conversion.

- Customized printer support:

Image configuration objects are used with the image print transform function to specify certain characteristics of the converted data streams. When associated with the device description information for a printer connected to the AS/400 system, image configuration objects act as a template for the converted data stream. Attributes, such as data stream format, color, and resolution, are all specified in the image configuration object.

- Additional capabilities:

In addition to converting data from one format to another, other functions can be performed by the image print transform function. Among these are the ability to reduce color, compress data, and change photometricity. For more information about the features of the image print transform function, consult *AS/400 System API Reference*, SC41-5801.

Note: You cannot perform functions that your printer does not support. For example, you cannot print in landscape orientation when your printer only supports portrait orientation.

7.3 Image print transform process

The image print transform function converts data from one image or print data stream format to another. In the process, image processing functions can be performed, including conversion from color to gray to bi-level, re-sizing, compression, and decompression.

The convert image API (QIMGCVTI) accepts an input data stream from an integrated file system (IFS) file, a spooled file, or memory, and sends the converted data stream to a file, spooled file, or memory.

The user may select an image configuration to describe the output data similar to selecting a device description. Image print transform determines the required transformations from the input data stream and the image configuration object without further assistance from the user. The interfaces also allow the user to directly specify attributes of the input and output data streams or to override individual attributes in the image configuration.

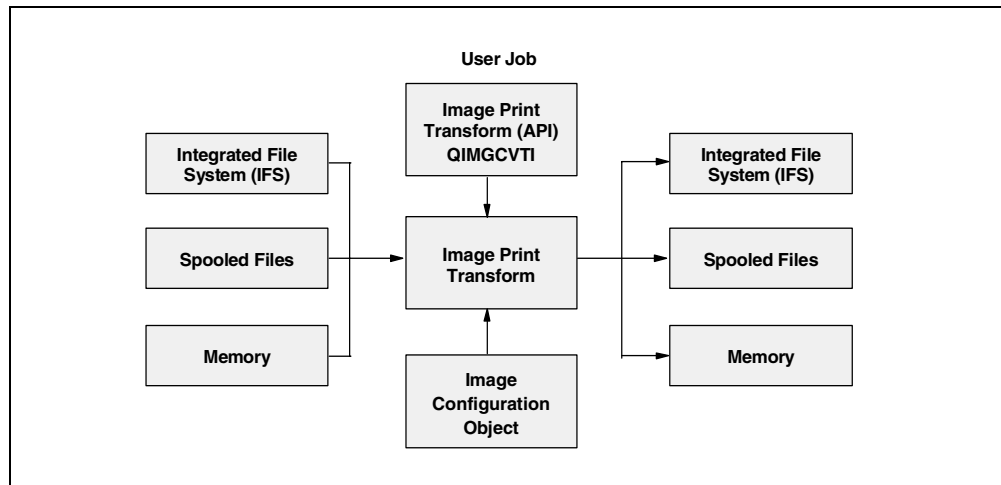

Figure 119. Converting data streams using image print transform

In pre-spool mode (Figure 119), image print transform runs in the job calling the API. Input parameters, along with the image configuration object, are used to control the transform. A new spooled file is created, and image print transform writes the converted data stream to it. It also sets the appropriate spooled file attributes to describe the data stream (print data).

Image print transform is integrated with spooled file processing so that any of the supported data stream formats can be spooled to any dot-addressable printer connected to the AS/400 system. The AS/400 system detects and performs the required transforms without assistance from the user. To achieve this goal, image print transform is called by the same application program interface (API) that calls the host print transform.

Although most users choose to delay any transforms until print time, the API also allows transforms before spooling the file. Therefore, the user can control whether the processing occurs in pre-spool or post-spool mode.

In post-spool mode, see Figure 120 on page 164 if the target printer is an ASCII printer. See Figure 121 on page 164 if the target printer is an IPDS AFP(*YES)

printer. The image print transform function is called automatically by the system as part of spool processing.

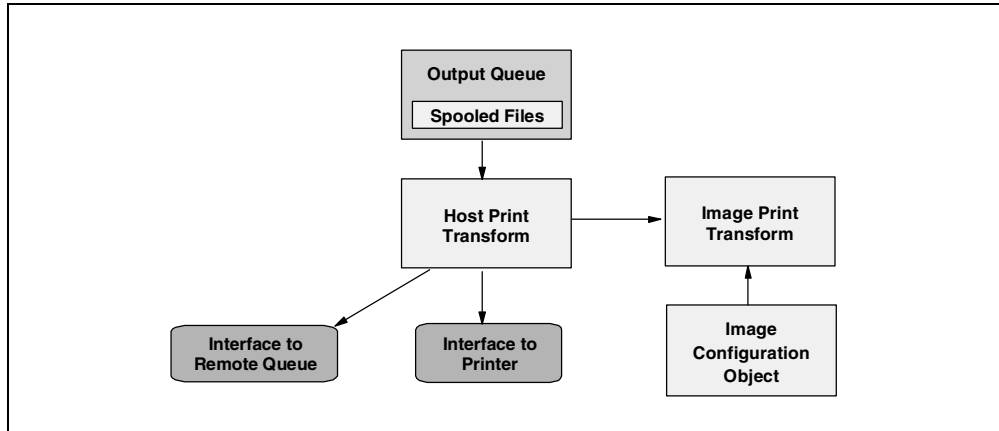

Figure 120. Printer writer or remote writer with HPT (*YES)

The driver for ASCII printers calls the host print transform API interface program, which reads the spooled file attributes to determine whether to call host print transform or the image print transform post-spool interface. If the image print transform post-spool interface is called, it reads the device description, image configuration object, and the spooled file attributes directly to determine the required output format and resolution of the printer. If data-stream transform is not possible, the post-spool interface returns an indicator to that effect to the host print transform API interface program.

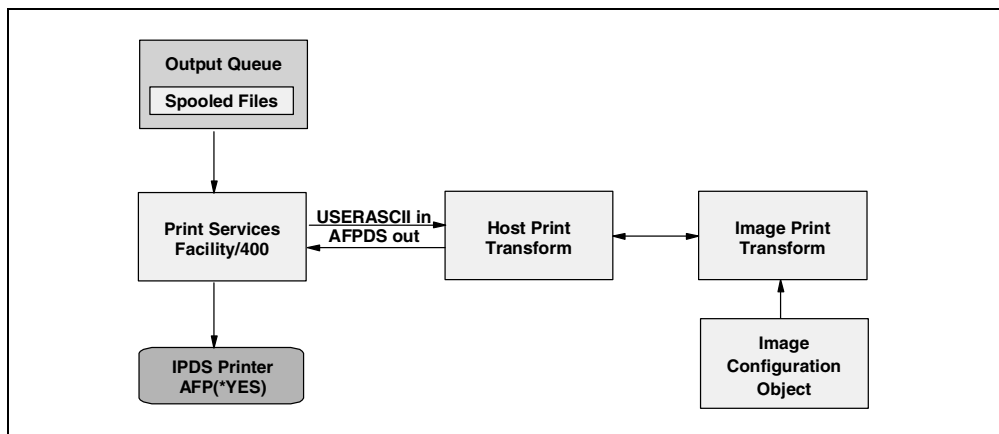

Figure 121. Image print transform and PSF/400

If the target printer is IPDS (AFP*YES), Print Services Facility/400 (PSF/400) selects a spooled file to be processed. If the spooled file is *USERASCII, PSF/400 calls host print transform to find out if the spooled file can be transformed. If the spooled file can be transformed, image print transform makes the transformation, one buffer at a time, into AFPDS depending on the printer device description image configuration object and passes the transformed buffer back to PSF/400.

Note: As the spooled file is transformed buffer by buffer, this process results in poor performance. Consider the usage carefully.

If the spooled file cannot be transformed, the spooled file is held, and an error message is returned to the QSYSOPR message queue.

7.3.1 Where output attributes are derived

The following output attributes are derived from the image configuration object unless specified otherwise in the user-defined data attribute of the spooled file:

- Data stream format
- Photometric interpretation
- Resolution units
- Horizontal resolution
- Vertical resolution
- Compression type
- Bits per sample
- No print borders (left, right, top, bottom)

The following output attributes are derived from the printer file (for example, spooled file attributes) if the output data stream format is AFPDS and the printer is an IPDS printer that has AFP(*YES) specified in the configuration.

- Output queue
- Paper size

The output attribute paper size is derived from the printer device description if the output data stream format is PCL5 or PostScript.

7.4 Printing with the image print transform function

The image print transform function works with both ASCII and IPDS printers that have AFP(*YES) specified in the configuration. When the image print transform function is used, the transform does not take place until after the data stream is spooled. Then, when the spooled file is printed or sent to a remote output queue, it is first sent to the image print transform function to be transformed.

Once a printer device is created with the image print transform function enabled, printing with the image print transform function is done automatically.

7.4.1 Printing to an ASCII printer

To enable the image print transform function when printing to an ASCII printer, complete the following steps:

- Ensure that the spooled file is a *USERASCII spooled file.
- Verify that the printer device description has the TRANSFORM field set to *YES.
- Verify that the printer device description has the IMGCFG field set to a valid value other than *NONE.

The TRANSFORM field and the IMGCFG field can be set when the device description is created with the CRTDEVPRT command, or changed after the device description is created with the CHGDEVPRT command.

7.4.2 Printing to an IPDS printer

To enable the image print transform function when printing to an IPDS printer that has AFP(*YES) specified in the configuration, complete the following steps:

- Ensure that the spooled file is a *USERASCII spooled file.
- Verify that the printer device description has the IMGCFG field set to a valid value other than *NONE.

The IMGCFG field can be set either when the device description is created with the CRTDEVPRT command, or changed after the device description is created with the CHGDEVPRT command.

7.4.3 Sending the spooled files

To enable the image print transform function when using remote system printing for sending the spooled files through a remote output queue, complete the following steps:

1. Ensure that the spooled file is a *USERASCII spooled file.
2. Verify that the output queue has the TRANSFORM field set to *YES.
3. Verify that the output queue has the IMGCFG field set to a valid value other than *NONE.

The TRANSFORM field and the IMGCFG field can be set when the output queue is created with the Create Output Queue (CRTOUTQ) command, or changed after the output queue has been created with the Change Output Queue (CHGOUTQ) command.

7.5 Image configuration objects

An image configuration object contains various printer characteristics that the image print transform function and the convert image API use when creating output. An image configuration object is basically a list of characteristics that is supported by the printer it represents, acting as a template that guides the transform process. Each image configuration object has values for the following fields:

- Image format
- Photometric interpretation
- Bits per sample
- Resolution units
- Horizontal resolution
- Vertical resolution
- Compression type
- No-print borders (left, right, top, bottom)

All of these fields can be overridden by using the convert image API and specifying a value for the field of the same name.

7.5.1 Values of image configuration objects

The following special values are allowed for the image configuration (IMGCFG) field of the CRTDEVPRT, CHGDEVPRT, CRTOUTQ, and CHGOUTQ commands.

You can also use these values when calling the convert image API. For more information, see *AS/400 System API Reference*, SC41-5801.

Each special value is described in terms of the data streams that are supported, the maximum resolution in dots per inch (dpi), and whether the printer has color or does not support compression.

The following list contains examples of image configuration objects, grouped by type of printer.

Note: For a complete list of all the image configuration objects, see *AS/400 Printer Device Programming*, SC41-5713, or *AS/400 System API Reference*, SC41-5801.

- **Printers supporting PCL data streams (*IMGA01-*IMGA09)**

- *IMGA01 PCL 300-dpi printer
- *IMGA04 PCL 300-dpi color printer

- **Printers supporting PostScript data streams (*IMGB01-IMGB15)**

- *IMGB01 PostScript 300-dpi printer
- *IMGB04 PostScript 300-dpi color printer

- **Printers supporting IPDS data streams (*IMGC01-*IMGC11)**

- *IMGC01 IPDS 240-dpi printer
- *IMGC02 IPDS 300-dpi printer

- **Printers supporting PCL and PostScript data streams (*IMGD01-*IMGD11)**

- *IMGD01 PCL/PostScript 300-dpi printer
- *IMGD02 PCL/PostScript 600-dpi printer

The recommended image configuration objects for some common printers are in the following list.

Note: For a complete list, see *AS/400 Printer Device Programming*, SC41-5713, or *AS/400 System API Reference*, SC41-5801.

- *IMGB11 Epson Stylus Color 600, 800 with PostScript
- *IMGD01 HP Laserjet III, IIID, IIISi, 4L with PostScript
- *IMGA02 HP Laserjet 4, 4P, 4V, 4Si, 4 Plus
- *IMGA02 HP Laserjet 5, 5P, 5Si
- *IMGA02 HP Laserjet 6, 6P, 6L
- *IMGC01 IBM 3130, 3160-1 AF Printer (240-pel mode)
- *IMGC02 IBM 3130 AF Printer (300-pel mode)
- *IMGC06 IBM 4028 Laser Printers
- *IMGB05 IBM 4303 Network Color Printer
- *IMGC06 IBM 4312, 4317, 4324 NP with IPDS feature (LAN)
- *IMGA02 IBM 4312, 4317, 4324 NP (ASCII/LAN)
- *IMGD02 IBM 4312, 4317, 4324 NP with PostScript (ASCII/LAN)
- *IMGC03 IBM Infoprint 60
- *IMGC05 IBM Infoprint 62 Model 2
- *IMGC06 IBM Infoprint 62 Model 3
- *IMGC05 IBM Infoprint 4000
- *IMGA02 Lexmark Optra S Printers
- *IMGD05 Lexmark Optra SC Color Printer
- *IMGA02 Okidata OL800, OL810 LED Page Printers

*IMGD04	QMS Magicolor CX
*IMGB06	Tektronix Phaser 560
*IMGA02	Xerox 4230 DocuPrinter

7.6 Printing with the convert image API

The convert image QIMGCVTI API provides the same transform capabilities as the image print transform function. In addition, printing with the convert image API gives the user more control over how the output looks than the image print transform function offers. It gives the user the ability to immediately transform a data stream when delaying the transform is not desired. It also has more options regarding the type of input object and output object. The convert image API supports input and output from an integrated file system (IFS) file, a spooled file, or main storage.

The convert image API can generate a spooled file that is transformed with the image print transform function. When this is done, the convert image API stores all the values needed to do the transform in the user-defined data attribute of the spooled file for later use by the image print transform function when the transform is performed. For more information on how to use the convert image API, see the *AS/400 System API Reference*, SC41-5801.

7.7 Converting PostScript data streams

Converting PostScript data streams is performed differently from converting image data streams. PostScript conversion requires the font files to rasterize the data. You can also find more debugging and message information if the PostScript file does not convert correctly.

7.7.1 Fonts

To convert PostScript files effectively, PostScript fonts are required to convert text and symbols into bit-mapped images. The following lists of fonts are supplied by IBM for use with the image print transform function. Each set of fonts is located in the IFS in the specified directory. For each font name, there is a corresponding font file containing rasterization information. This information is stored in the psfonts.map file.

Note: *Do not* alter the font files or the psfonts.map file shipped with OS/400. Changing a font file or font mapping can cause the image print transform function to produce unpredictable as well as undesirable results.

The Latin fonts are stored in the /QIBM/ProdData/OS400/Fonts/PSFonts/Latin directory.

The Symbol fonts are stored in the /QIBM/ProdData/OS400/Fonts/PSFonts/Symbols directory.

Note: For a list of the IBM supplied PostScript fonts, see *AS/400 Printer Device Programming*, SC41-5713.

7.7.2 User-supplied fonts

To enhance the capabilities of the image print transform function, you can add your own font files to be used in conjunction with the IBM-supplied fonts shipped with OS/400. These fonts are called user-supplied fonts. They need to be stored in the `/QIBM/UserData/OS400/Fonts/PSFonts` directory:

The user-supplied font mapping file (`psfonts.map`) is stored in the same directory as the user supplied fonts. It behaves the same way as the `psfonts.map` file that is shipped with OS/400. An important difference is that you can find user-supplied fonts by looking first at the user-supplied font mapping file and then at the OS/400 font mapping file.

To add a user-supplied font, complete the following steps:

1. Use an ASCII text editor to open the `psfonts.map` file located in `/QIBM/UserData/OS400/Fonts`. If this file does not exist, you need to create it.
2. Add a new line to the file to include the new font name and associated path and file name, for example:

```
font MyNewFont      /QIBM/UserData/OS400/Fonts/PSFonts/MNF.PFB
```

Here, *MyNewFont* is the name of the font, and *MNF.PFB* is the associated font file.

3. Save the new `psfonts.map` file.
4. Copy the font file into the directory specified in the `psfonts.map` file.

To delete a user-supplied font, simply remove the line mapping the font name to its associated file in **psfonts.map**, and remove the font file from the AS/400 system.

7.7.3 Font substitution

When a font requested within a PostScript data stream is not available on the AS/400 system, a font substitution can be defined if there is a similar font available. *Font substitution* is the mapping of a font name to a font that is available and similar (in terms of its rasterization properties) to the font file being replaced. You can also specify font substitution if existing font mapping is producing undesirable output.

To define a font substitution, complete the following steps:

1. Use an ASCII text editor to open the `psfonts.map` file that is located in `/QIBM/UserData/OS400/Fonts`. If this file does not exist, you need to create it.
2. Add a new line to the file to include the font name and the path and file name of the font file you want to use as a substitute, for example:

```
font Courier      /QIBM/UserData/OS400/Fonts/PSFonts/HEL.PFB
```

3. Save the new `psfonts.map` file.

7.8 Troubleshooting

The following answers are to questions that may arise when you use the image print transform function or convert image API:

- Why does it take so long to process PostScript data streams?

One reason why PostScript data streams take a long time to process is the amount of information that needs to be transformed. Color documents especially require large amounts of memory and many data conversions, which means longer processing times.

Note: If the photometricity of the converted data stream is not requested, it is assumed, by default, to be RGB, or color. However, if you know you do not want RGB, or the data stream is not color, specify an image configuration object that only supports black and white output. This greatly increases the throughput of the image print transform function and speeds up PostScript processing.

- Why is the converted data stream positioned incorrectly on or off the page? Why is it not centered?

The resolution specified in the image configuration object is probably not supported by the printer with which the object is configured. When this happens, an incorrect no-print border is retrieved from the image configuration object and the data is consequently positioned incorrectly on the output page. The printer may also be set up to automatically add a no-print border, which will cause the output generated by the image print transform function to be shifted on the page. Verify that the correct image configuration object is being used with the printer, and that the printer has been set up properly and has been physically calibrated.

- Why did my PostScript data stream *not* generate a new data stream?

Chances are that the PostScript data stream did not contain any printable data. To verify this, check the job log of the writer invoking the image print transform function. Look for a message indicating no printable data was found. If no message exists, an error may have occurred processing the file, in which case, refer to the PostScript processing job for more information.

- Why is the printed image three times the original size when converted from color or gray scale to black and white?

When a color image or gray scale image is converted to black and white, a dithering process takes place. In this process, a single color or gray scale pixel is transformed into a 3x3 matrix of pixels. Each pixel within this matrix is either black or white, depending on the color being rendered.

Chapter 8. Remote system printing

Remote system printing allows spooled files created on an AS/400 system to be automatically sent to and printed on other systems.

8.1 Remote system printing overview

The source system must be at Version 3.0 Release 1.0 or later to support remote system printing. The spooled files are sent from an output queue using the Start Remote Writer (STRRMTWTR) command. The STRRMTWTR command allows spooled output files to be automatically sent to other systems using SNA distribution services (SNADS), Transmission Control Protocol/Internet Protocol (TCP/IP), or Internetwork Packet Exchange (IPX). A user-defined connection is also supported with all the destination types (DESTTYPE).

Figure 122 shows the physical connections and the communications protocols used to connect the remote systems.

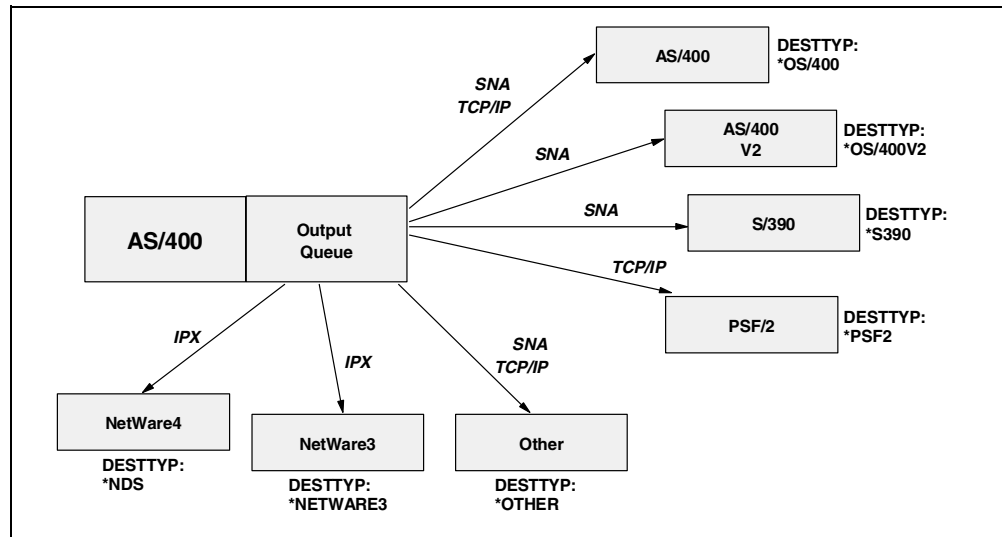

Figure 122. Remote system printing overview

The following parts of remote system printing are already documented with configuration examples, supported data stream tables, and AFP resources considerations in either *AS/400 Printer Device Programming*, SC41-5713, or *AS/400 Printing IV*, GG24-4389, and are not discussed in this chapter.

- AS/400 to AS/400 Version 3 and later
- AS/400 to AS/400 Version 2
- AS/400 to S/390 system
- AS/400 to Print Services facility/2 (PSF/2)
- AS/400 to RS/6000 (with destination type *OTHER)

Note: See Appendix H, “AS/400 to AIX printing” on page 367, for more information.

8.2 AS/400 system and TCP/IP LPR-LPD printing

You can request to have your spooled file sent and printed on any system in your TCP/IP network. The line printer requester (LPR) is the sending, or client portion, of a spooled file transfer. On the AS/400 system, the Send TCP/IP Spool File (SNTCPSPLF) command, the TCP/IP LPR command, or remote system printing provide this function by allowing you to specify what system you want the spooled file printed on and how you want it printed. When sending a spooled file, the host print transform function can also be used to transform SCS or AFPDS spooled files into ASCII.

Printing the file is done by the printing facilities of the destination system. The destination system must be running TCP/IP. The line printer daemon (LPD) is the process on the destination system that receives the file sent by the LPR function (Figure 123).

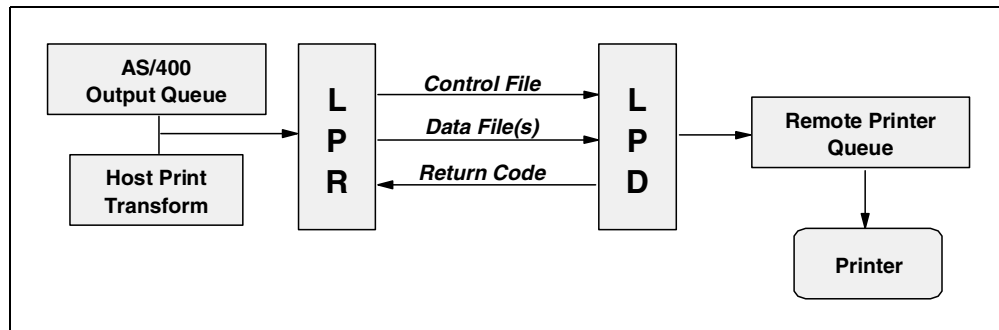

Figure 123. TCP/IP line printer requester: Line printer daemon

The objective of this section is to explain the case when the target printer is connected using an interface such as an IBM Network Printer with a LAN card, an IBM Network Print Server, an HP JetDirect card, or a Lexmark MarkNet XLe.

Note: If the target printer supports PJL/PCL commands and you are at Version 3.0 Release 7.0 or later, we recommend that you connect your printer directly on the LAN with the PJL driver. For detailed information, see 11.2.2, “Configuring LAN-attached ASCII printers using PJL drivers” on page 241.

8.2.1 Creating the output queue

To create the remote output queue for your printer. Follow these steps:

1. Type the `CRTOUTQ` (Create Output Queue) command on any command line and press the F4 (Prompt) function key. The display shown in Figure 123 appears.

Note: The following Create Output Queue displays are at V3R7 and later. Some parameters are not present at V3R1, V3R2, or V3R6.

```

                                Create Output Queue (CRTOUTQ)
Type choices, press Enter.
Output queue . . . . . RMT          Name
Library . . . . . MYLIB          Name, *CURLIB
Maximum spooled file size:
Number of pages . . . . . *NONE      Number, *NONE
Starting time . . . . .           Time
Ending time . . . . .           Time
      + for more values
Order of files on queue . . . . . *FIFO      *FIFO, *JOBNBR
Remote system . . . . . *ININETADR

                                                                Bottom
F3=Exit  F4=Prompt  F5=Refresh  F10=Additional parameters  F12=Cancel
F13=How to use this display  F24=More keys

```

Figure 124. Create Output Queue (Part 1 of 6)

2. On this display, enter the following parameter values:

- **Output queue:** The name of your output queue (in this example, RMT)
- **Library:** A library name (in this example, MYLIB)
- **Remote system:** *ININETADR or the host name (if defined in TCP/IP Host Table Entries)

Leave the default value for the other parameters, and press the Enter key to continue. The display shown in Figure 125 appears.

```

                                Create Output Queue (CRTOUTQ)
Type choices, press Enter.
Output queue . . . . . > RMT          Name
Library . . . . . MYLIB          Name, *CURLIB
Maximum spooled file size:
Number of pages . . . . . *NONE      Number, *NONE
Starting time . . . . .           Time
Ending time . . . . .           Time
      + for more values
Order of files on queue . . . . . *FIFO      *FIFO, *JOBNBR
Remote system . . . . . > *ININETADR

Remote printer queue . . . . . 'PASS'

                                                                More...
F3=Exit  F4=Prompt  F5=Refresh  F10=Additional parameters  F12=Cancel
F13=How to use this display  F24=More keys

```

Figure 125. Create Output Queue (Part 2 of 6)

3. On this display, enter the parameter value for Remote printer queue. The name of the remote printer queue is determined by the interface used. In this example, the target printer is an IBM Network Printer with a LAN interface card and the queue name is PASS. See 12.1.9, “Remote printer queue names” on page 258, for the recommended queue names depending on the type of interface used (HP JetDirect, MarkNet XLe, and so on).

To continue, press the Page Down key. The display shown in Figure 126 on page 174 appears.

```

                                Create Output Queue (CRTOUTQ)
Type choices, press Enter.
Writers to autostart . . . . . 1          1-10, *NONE
Queue for writer messages . . . QSYSOPR   Name
  Library . . . . . *LIBL             Name, *LIBL, *CURLIB
Connection type . . . . . *IP          *SNA, *IP, *IPX, *USRDFN
Destination type . . . . . *OTHER      *OS400, *OS400V2, *PSF2...

                                                                Bottom
F3=Exit  F4=Prompt  F5=Refresh  F10=Additional parameters  F12=Cancel
F13=How to use this display  F24=More keys

```

Figure 126. Create Output Queue (Part 3 of 6)

4. On this display, enter the following parameter values:

- **Writer to autostart:** 1
- **Connection type:** *IP
- **Destination type:** *OTHER

Leave the default values for the other parameters, and press the Enter key to continue. The display shown in Figure 127 appears.

```

                                Create Output Queue (CRTOUTQ)
Type choices, press Enter.
Writers to autostart . . . . . *NONE      1-10, *NONE
Queue for writer messages . . . QSYSOPR   Name
  Library . . . . . *LIBL             Name, *LIBL, *CURLIB
Connection type . . . . . > *IP       *SNA, *IP, *IPX, *USRDFN
Destination type . . . . . > *OTHER   *OS400, *OS400V2, *PSF2...
Host print transform . . . . . *YES     *YES, *NO

                                                                Bottom
F3=Exit  F4=Prompt  F5=Refresh  F10=Additional parameters  F12=Cancel
F13=How to use this display  F24=More keys

```

Figure 127. Create Output Queue (Part 4 of 6)

5. On this display, leave the default value (*YES) for the host print transform parameter. To continue, press the Enter key. The display shown in Figure 128 appears.

```

                                Create Output Queue (CRTOUTQ)
Type choices, press Enter.
Writers to autostart . . . . . *NONE          1-10, *NONE
Queue for writer messages . . . QSYSOPR      Name
  Library . . . . . *LIBL          Name, *LIBL, *CURLIB
Connection type . . . . . > *IP            *SNA, *IP, *IPX, *USRDFN
Destination type . . . . . > *OTHER        *OS400, *OS400V2, *PSF2...
Host print transform . . . . . *YES         *YES, *NO
Manufacturer type and model . . *IBM4317
Workstation customizing object *NONE          Name, *NONE
  Library . . . . . Name, *LIBL, *CURLIB
Internet address . . . . . '123.1.2.3'
Destination options . . . . . *NONE
Print separator page . . . . . *YES         *YES, *NO

More...
F3=Exit  F4=Prompt  F5=Refresh  F10=Additional parameters  F12=Cancel
F13=How to use this display  F24=More keys

```

Figure 128. Create Output Queue (Part 5 of 6)

6. On this display, enter the following parameter values:

- **Manufacturer type and model:** Enter a value according your target printer type (in this example, *IBM4317).
- **Internet address:** The IP address of your printer (in this example, 123.1.2.3)
Note: The Internet address is only prompted for if *INTNETADR is specified for the remote system.
- **Destination options:** *NONE, see the following section for a discussion of this parameter.
- **Print separator page:** For V3R7 and later, enter *YES or *NO. For V3R1, V3R2, and V3R6, see 8.2.3, “Separator pages” on page 178, for an alternate solution.

To continue, press the Page Down key to view the display shown in Figure 129.

```

                                Create Output Queue (CRTOUTQ)
User defined option . . . . . *NONE          Option, *NONE
  + for more values
Type choices, press Enter.
User defined object:
  Object . . . . . *NONE          Name, *NONE
  Library . . . . . Name, *LIBL, *CURLIB
  Object type . . . . . *DTAARA, *DTAQ, *FILE...
User driver program . . . . . *NONE          Name, *NONE
  Library . . . . . Name, *LIBL, *CURLIB
Text 'description' . . . . . Remote output queue for 4317

Bottom
F3=Exit  F4=Prompt  F5=Refresh  F10=Additional parameters  F12=Cancel
F13=How to use this display  F24=More keys

```

Figure 129. Create Output Queue (Part 6 of 6)

7. Enter a text description for your output queue (in this example, "Remote output queue for 4317") and leave the default values for the other parameters (these parameters are V3R7 only).
8. Press the Enter key to create the output queue.
9. When the configuration is completed, complete the following steps:
 - a. Test the TCP/IP connection, using the PING command, with the IP address of your printer.
 - b. If the PING is successful:
 - Start the remote writer:

```
STRRMWTR OUTQ(outputq_name)
```
 - Print something (for example, a print screen).
 - c. If either the PING fails or you are unable to print, then you are in troubleshooting mode (see 12.1, "Communication, connection, and configuration problems" on page 253).

8.2.2 Destination options

When CNNTYPE(*IP) is specified, destination-dependent options are added to the control file that is sent to the LPD server. When CNNTYPE(*IPX) is specified, this field is used to determine how spooled files are handled once they are sent to the remote system.

The destination options are up to 128 characters of filters and predefined options enclosed in apostrophes. The options are separated by one or more blanks.

Note: Anything that is not recognized as a filter, a predefined option, or a reserved character is passed to the remote system.

The following predefined options apply to processing by LPR under OS/400 and are specified in the DESTOPT parameter:

- ***USRDFNTXT**

This predefined option sends the current user-defined text of the user profile as options to the remote system. The user-defined text of the user profile can be set using the system application program interface (API) CHGUSRPTI. The text can be displayed using the system API DSPUSRPTI or by displaying the spooled file attributes.

- ***NOWAIT**

This option is only valid if the connection type *IPX is used.

- **J**

This option overrides the default job name for the banner page printed on the remote system, if a banner page is printed at all. The characters immediately following the "J" are used as the job name. For example, to specify a job name of "Jd12", specify:

```
DESTOPT('JId12')
```

- **XAIX**

This option is used in the TCP/IP environment only. This option tells the local AS/400 system how to produce multiple copies on the remote system.

If “XAIX” is *not* specified (the default), one print command per copy requested is placed in the control file. This control file and a single copy of the data is then sent to the remote system. However, some remote systems (similar to most direct LAN attached printers) ignore multiple print commands within the control file. Therefore, the other method might be preferred.

If “XAIX” is specified, OS/400 places one print command in the control file and sends it together with the data multiple times to the remote system, depending on the Number of copies parameter of the spooled file attributes.

Note: If the XAIX option has been specified, but the LPD does not support this method, message TCP3701 (Send request failed for spooled file) is returned. However, one copy may still print, depending on the LPD implementation. When the send request fails, the remote writer will try sending again, continuing until the spooled file is held.

- **XAUTOQ**

If the connection to the remote system times out during transformation of the spooled file into ASCII by the host print transform, with this option, the transformed spooled file is sent back to the same output queue using the AS/400 LPD server rather than failing with a timeout error. The transformed spooled file name is modified to be unique. Then, since the spooled file is already in ASCII, it is sent directly to the target printer without any transformation and avoids a timeout.

Note: When using TCP/IP LPR-LPD and the host print transform function, we recommend that the subsystem QSPL has a minimum size of 6 MB.

To implement this function, you need to specify the new DESTOPT parameter, XAUTOQ. On the LPR, or the SNDTCPSPLF, CRTOUTQ, or CHGOUTQ command, the parameter is capitalized. The AS/400 LPD server must also be running. Check for server jobs with the command:

```
WRKACTJOB SBS(QSYSWRK) JOB(QTLPD*)
```

This displays all LPD servers started with names QTLPDnnnnn, where *nnnnn* are unique identifying numbers. If no servers are displayed or you want to start an additional server, use the command:

```
STRTCPSVR SERVER(*LPD)
```

The number of servers started is determined by the TCP/IP configuration. Starting multiple servers increases their availability since each processes one job at a time.

Messages are logged to indicate whether auto-queueing is needed. When the following messages are received, the remote system times out and the transformed spooled file is sent to the same output queue:

```
TCP342F Remote host system closed connection unexpectedly.  
TCP3600 Spooled file sent.
```

When the following messages are received, the remote system times out and the AS/400 LPD server is not available to receive the transformed spooled file:

```
TCP342F Remote host system closed connection unexpectedly.  
TCP3701 Send request failed for spooled file.
```

When the transformed spooled file is sent to the original output queue, the spooled file name is changed to LPDzzzz to indicate that it was received by LPD. zzzz indicates identifying alphanumeric characters. The job name is

changed to QPRTJOB, and the user data is set to the original file name. The job number and spooled file number are determined from the LPD server. The original spooled file can be kept or deleted. This occurs after the file has been sent, even if it is sent back to the original queue. If the transformed file is sent to the original queue, it is deleted after it has been sent to the remote system.

Most of the commands and filters of the line printer daemon protocol can be specified in the DESTOPT parameter, but some are reserved for use by LPR.

These exceptions are:

- **Supported print filters:**

Any option starting with one of the following characters is interpreted as a print filter. This character is built into the print command sent to LPD in the control file. The filter is for use by the LPD daemon to modify the printed output, but how this is used depends on the LPD implementation.

c, d, f, g, l, n, p, r, t, and v

The meaning of some flags are:

- **f**: Print file as plain text. Many ASCII control characters may be discarded (except BS, CR, HT, FF, and LF).
- **l**: This flag is the default. It keeps all ASCII control characters.
- **p**: This filter causes the file to be printed in “pr” format. It prints headings (date, time, title, etc.) and page numbers.

- **Reserved characters:**

There are also some reserved characters. These character are used by the SNTDTPSPLF command for the control file. An option must not start with one of the following characters:

K, C, H, I, L, M, N, P, S, T, U, W, 1, 2, 3, and 4

For example, CLASS=ASCII is not allowed because the character “C” is reserved for use by the SNTDTPSPLF command. However, “-CLASS=ASCII” is permitted.

The meaning of some characters are:

- **H**: Name of the sending host, set by LPR to the AS/400 configured name.
- **L**: Print banner page command, added by LPR if print separator page *YES is specified (default).
- **M**: Send mail to a given user ID when printed (not supported).

The meaning of the previous commands and filters can be found in the line printer daemon protocol reference documentation. This documentation has no IBM form number, but can be found in several places on the Internet.

8.2.3 Separator pages

The Print separator page parameter is only available on V3R7 and later. If you are running V3R1, V3R2, or V3R6, you can suppress the separator page by creating data area QTMPLPR of type *CHAR in library QTCP. Specify an authority of *USE to prevent normal users from changing the data area:

```
CRDTAARA DTAARA (QTCP/QTMPLPR) TYPE (*CHAR) AUT (*USE)
```

Note: This task must be performed by someone who has at least *CHANGE authority to the QTCP library.

The option to omit the separator page request is turned on or off based on the value of the first character in the data area. If this character is a capital N, the option is enabled. If it is any other character, the option is disabled. If the data area does not exist, the option is disabled.

- To enable (suppress the separator page) enter:

```
CHGDTAARA DTAARA(QTCP/QTMPLPR (1 1)) VALUE('N')
```

- To disable (print the separator page) enter:

```
CHGDTAARA DTAARA(QTCP/QTMPLPR (1 1)) VALUE('')
```

8.2.4 'Load Letter' message on the printer

If the host print transform function is used and if the page size parameter in your printer file does not match a page size entry in the MFRTYPMDL (Manufacturer type, and mode) or WSCST (Workstation Customizing) object, Letter format is used as the default format. In this case, if the printer is loaded with a paper format other than Letter, the message "Load Letter" may be displayed on your printer.

This problem occurs especially when using an A4 paper format. To circumvent the problem, complete the following steps according to your OS/400 version and release, substituting your own values for the various parameters:

8.2.4.1 For V3R1 and V3R6

Follow these steps:

1. To retrieve the workstation customized object, type the following command:

```
RTVWSCST DEVTYPE(*TRANSFORM) MFRTYPMDL(*IBM4317) SRCMBR(NP17SRC)
SRCFILE(QGPL/QTXTSRC)
```

Note: For the MFRTYPMDL parameter, enter a value depending on your target printer (in this example, *IBM4317), and use your own values for SRCMBR and SRCFILE.

2. Use SEU to edit the source file:

```
STRSEU SRCFILE(QGPL/QTXTSRC) SRCMBR(NP17SRC)
```

3. Page through the source file until you find the following tag (around statement 0001.67):

```
:PAGESIZE
    PAGWTH=12240
    PAGLEN=15840
    DATA='1B266C303241'X.
```

4. Change the escape sequence in the DATA parameter to:

```
DATA='1B266C323641'X.
```

Note: This changes the value Letter ('3032') to A4 ('3236').

5. Exit the SEU source edit (press F3 and Enter).
6. To create a customized workstation configuration object, type the following command:

```
CRTWSCST WSCST(QGPL/NP17A4) SRCMBR(NP17SRC)
```

You will receive the message “Customization object NP17A4 created successfully”.

7. Stop the remote writer:

```
ENDWTR WTR(outputq_name) OPTION(*IMMED)
```

8. To change the output queue, enter the `CHGOUTQ` command, and press the F4 (Prompt) function key. Then page down until you find the parameters shown in Figure 130.

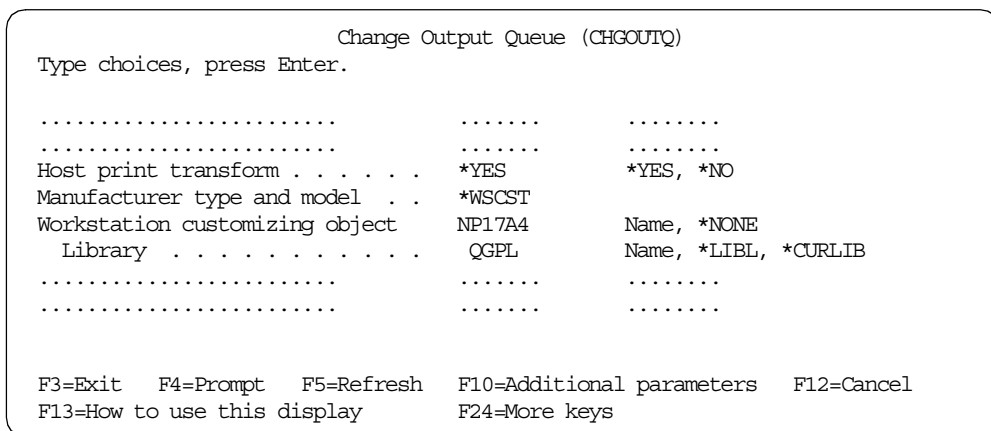

Figure 130. Change Output Queue: HPT and WSCST parameter

On this display, enter the following parameter values:

- **Manufacturer type and model:** *WSCST
- **Workstation customizing object:** NP17A4 (the object that you created with the command CRTWSCST)
- **Library:** QGPL (the library specified in the CRTWSCST command)

9. Press the Enter key to modify your output queue.

8.2.4.2 For V3R2, V3R7, and later

Follow these steps:

1. To retrieve the workstation customized object, type the following command:

```
RTVWSCST DEVTYPE(*TRANSFORM) MFRTYPMDL(*IBM4317) SRCMBR(NP17SRC)
SRCFILE(QGPL/QXTSRC)
```

Note: For the MFRTYPMDL parameter, enter a value depending on your target printer (in this example, *IBM4317), and use your own values for SRCMBR and SRCFILE.

2. Create a customized workstation configuration object:

```
CRTWSCST WSCST(QGPL/NP4317) SRCMBR(NP17SRC)
```

You will receive the message “Customization object NP4317 created successfully”.

3. Stop the remote writer:

```
ENDWTR WTR(outputq_name) OPTION(*IMMED)
```

4. To change the output queue, enter the `CHGOUTQ` command, and press the F4 (Prompt) function key. Then page down until you find the parameters shown in Figure 131.

```

Change Output Queue (CHGOUTQ)
Type choices, press Enter.

.....
.....
.....
Host print transform . . . . . *YES          *YES, *NO
Manufacturer type and model . . *WSCSTA4
Workstation customizing object  NP4317      Name, *NONE
  Library . . . . .          QGPL          Name, *LIBL, *CURLIB
.....
.....

F3=Exit  F4=Prompt  F5=Refresh  F10=Additional parameters  F12=Cancel
F13=How to use this display  F24=More keys

```

Figure 131. Change Output Queue: HPT and WSCST parameter

On this display, enter the following parameter values:

- **Manufacturer type and model:** *WSCSTA4
- **Workstation customizing object:** NP4317 (the object that you created with the command CRTWSCST)
- **Library:** QGPL (the library specified in the CRTWSCST command)

5. Press the Enter key to modify your output queue.

8.3 AS/400 and NetWare printing

Beginning with Version 3.0 Release 7.0 of OS/400, remote system printing can now send spooled files to a NetWare server using the Internetwork Packet Exchange (IPX) protocol. The NetWare server can be either on the Integrated PC Server or a PC.

When you have the Enhanced Integration for NetWare feature (an optional part of OS/400 (5716-SS1 for V3R7 or 5769-SS1 for V4R1 and V4R2)), you can print from the AS/400 system to NetWare printers that use the standard NetWare print support.

NetWare uses a print queue, a print server, and a printer to allow a workstation to print to a network printer. The print queue is the object that temporarily holds the print job file until the job is printed. See Figure 132 for an illustration of the AS/400 system to NetWare printing process.

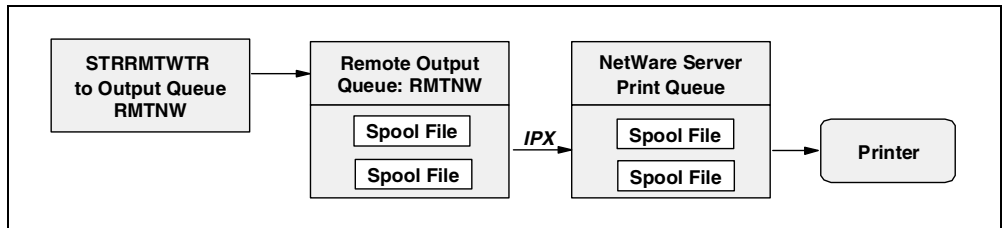

Figure 132. AS/400 system to NetWare printing

As each user's spooled job is processed on the output queue, the AS/400 system authenticates a connection for the user to the appropriate server. Each user must

have a NetWare authentication entry or use the Start NetWare Connection (STRNTWCNN) command to start a NetWare connection manually.

The Add NetWare Authentication Entry (ADDNTWAUTE) command adds authentication information for a server to a user profile. The information specifies how the user signs on to the server. This information is used to start authenticated connections to servers. An authenticated connection to a server is required to issue requests to the server. If an authenticated connection does not exist, the system attempts to start a connection using data stored in the authentication entries.

Note: Ideally, each user has an authentication entry authorizing them to the specified NetWare print queue. If users do not have an authentication entry, they must specify AUTJOB(*ANY) on the STRNTWCNN command.

8.3.1 Preparing for remote system printing

Preparation work must be done on both the source system (AS/400 system) and target system (NetWare server) for remote system printing to work. The following list shows what must be present or created before remote system printing can be used:

- On the AS/400 system Version 3.0 Release 7.0 or later, ensure that the Enhanced Integration for NetWare is installed.
- On the AS/400 system, configure and start Internet Packet Exchange (IPX) configuration support. For IPX configuration, see *Internet Packet Exchange (IPX) Support*, SC41-3400.
- On the NetWare Server, load the NetWare Enhanced Integration NLM. The file to be loaded is AS4NW410 for NetWare 4.10, or AS4NW312 for NetWare 3.12 servers.
- On the AS/400 system, use the STRNTWCNN AUTJOB(*ANY) command to connect to the NetWare server, or use the ADDNTWAUTE command if you want to start the STRNTWCNN automatically.
- On the NetWare server, ensure the NetWare User specified on the STRNTWCNN or ADDNTWAUTE command is a valid NetWare user.
- On the AS/400 system, use the CRTOUTQ command to create the remote output queue for NetWare printing.
- On the NetWare server, ensure the NetWare queue exists on a volume of a server that runs the NetWare Enhanced Integration NLM.

8.3.2 Creating an output queue

To create the remote output queue, type the Create Output Queue (CRTOUTQ) command on any command line, and press the F4 (Prompt) function key. The display shown in Figure 133 appears.

```

                                Create Output Queue (CRTOUTQ)
Type choices, press Enter.
Output queue . . . . . > RMTNTW          Name
Library . . . . . MYLIB          Name, *CURLIB
Maximum spooled file size:
Number of pages . . . . . *NONE      Number, *NONE
Starting time . . . . .           Time
Ending time . . . . .           Time
      + for more values
Order of files on queue . . . . *FIFO      *FIFO, *JOBNBR
Remote system . . . . . > IBM_TREE1

Remote printer queue . . . . . .NTW_QUEUE.ASPRT.NTWHP

More...

F3=Exit   F4=Prompt   F5=Refresh   F10=Additional parameters   F12=Cancel
F13=How to use this display   F24=More keys

```

Figure 133. Create Output Queue (Part 1 of 2)

On this display, enter the following parameter values:

- **Output Queue:** The name of your output queue (in this example, RMTNTW).
- **Library:** A library name (in this example, MYLIB).
- **Remote system:** For DESTTYPE(*NETWARE3), specify the name of the server for the Remote System parameter value.

For DESTTYPE(*NDS), you can specify either the name of the tree or the special value *NWSA for the remote system parameter. If you use *NWSA, the tree name is from DSPNWSA OPTION(*NETWARE).

In this example, we use DESTTYPE(*NDS) and the remote system name is the tree name IBM_TREE1.

- **Remote printer queue:** For DESTTYPE(*NETWARE3), specify the name of the server for the Remote Printer Queue parameter value.

For DESTTYPE(*NDS), the Remote Printer Queue parameter can be a distinguished name that begins with a period. If the name does not begin with a period, the name is a partial name and is used in conjunction with the NDS context specified in the system network server attributes (DSPNWSA) to form the distinguished name of the NetWare print queue.

In this example, we use DESTTYPE(*NDS), and the Remote Printer Queue parameter is a distinguished name that begins with a period (.NTW_QUEUE.ASPRT.NTWHP).

To continue, press the Page Down key until the display, like the example shown in Figure 134 on page 184, appears.

```

                                Create Output Queue (CRTOUTQ)
Type choices, press Enter.
Writers to autostart . . . . . 1          1-10, *NONE
Queue for writer messages . . . QSYSOPR   Name
  Library . . . . . *LIBL             Name, *LIBL, *CURLIB
Connection type . . . . . > *IPX       *SNA, *IP, *IPX, *USRDFN
Destination type . . . . . > *NDS      *OS400, *OS400V2, *PSF2...
Host print transform . . . . . *YES     *YES, *NO
Manufacturer type and model . . *IBM4039HP
Workstation customizing object *NONE   Name, *NONE
  Library . . . . . *NONE             Name, *LIBL, *CURLIB
Destination options . . . . . *NONE
User defined option . . . . . *NONE    Option, *SAME, *NONE
      + for more

More...
F3=Exit  F4=Prompt  F5=Refresh  F10=Additional parameters  F12=Cancel
F13=How to use this display  F24=More keys

```

Figure 134. Create Output Queue (Part 2 of 2)

Complete the parameters as shown in this list:

- **Writer to autostart:** 1
- **Connection type:** *IPX
- **Destination type:** *NETWARE3 or *NDS - (in this example, *NDS)
- **Host print transform:** *YES
- **Manufacturer type and model:** Enter a value according to your target printer type (in this example, *IBM4039HP)
- **User-defined option:** *NONE, *NOWAIT, *BANNER
 - ***NOWAIT:** The spooled file is removed from the AS/400 queue as soon as the entire file is sent to NetWare queue. If you do not select this option, the spooled file remains in the AS/400 output queue until the file is removed from the NetWare queue, which occurs either when the file is printed or when a NetWare utility is used to delete it.
 - ***BANNER= 'text':** Specify up to 12 characters that you want to print on a NetWare banner page. The banner page, which precedes the NetWare print job, also prints the user name.

Note: You must type *BANNER in uppercase letters. Enclose the text in single quotes, and make sure there are no spaces before and after the equal sign.

Press the Enter key to create the RMTNTW remote output queue.

Chapter 9. Client Access/400 printing

This chapter covers printing in the Client Access for Windows 95/NT environment. In this environment, it is possible to print PC application output on an AS/400 printer, AS/400 application output on a PC printer, or, by using a combination of these functions, print PC application output on another PC printer.

9.1 Client Access/400 printing overview

The ability to use 5250 printer emulation over native TCP/IP connections was introduced with Client Access for Windows 95/NT Version 3 Release 1 Modification 3 when OS/400 Version 4 Release 2 was available.

When using AS/400 Client Access for your printing needs, two different types of printing capabilities are provided:

- Printing PC application output to SCS, IPDS, or ASCII printers attached to the AS/400 system:

This function is called *Network Printing* (previously called *Virtual Print*). It allows PC users to identify AS/400-attached printers as their network attached printer.

Client Access/400 provides SCS and AFP Printer Drivers, which convert PC application output from ASCII to EBCDIC if the target printer is an SCS or IPDS printer. This conversion occurs on the PC before the spooled file is placed in an AS/400 output queue.

Note: The application output type also determines which driver, SCS or AFP, can be used.

Windows drivers have to be used if the target printer is an ASCII printer. In this case, the spooled file in the AS/400 output queue is shown with a *USERASCII Device Type (DEVTYPE) attribute.

- Printing AS/400 application output on a PC-attached printer:

In this case, AS/400 spooled files in an SCS or an AFP data stream must be converted into an ASCII printer data stream depending on the target PC printer. This conversion can be done by one of the following methods:

- PC5250 emulation based on a Windows printer driver:

The transformation takes place on the PC, and only SCS spooled files can be converted. No customization is possible.

- PC5250 emulation using Printer Definition Tables (PDT):

The transformation takes place on the PC, and only SCS spooled files can be converted. Printer functions can be adapted by modifying the Printer Definition Table (PDT). The modified PDT must be available on all PCs using the printer.

- OS/400 host print transform:

The transformation takes place on the AS/400 system. SCS and AFPDS spooled files can be converted. Customization is possible by modifying the Work Station Customizing (WSCST) object. The same WSCST object is used for all printers of a similar type.

Note: For detailed information on host print transform, see Chapter 6, “Host print transform” on page 137.

Redirecting PC application output via the AS/400 system to another PC printer in the network is a combination of the previous two capabilities. PC-generated output is sent to an AS/400 output queue in an ASCII printer data stream and then printed on a Client Access/400 attached ASCII printer. This brings the AS/400 spooling capabilities to PC application output.

9.2 Client Access/400 Network Printing

The Client Access/400 Network Printing (previously named virtual print) function allows you to print from a PC application to a printer attached somewhere in the network that is defined to an AS/400 system. The following examples of AS/400-attached printers can be used as target printers:

- SCS printers, twinax attached
- IPDS printers, configured AFP(*NO) or AFP(*YES), twinax or LAN attached
- ASCII printers, attached to PCs, displays, or LAN attached

For more information on printer attachment methods, see 1.4, “AS/400 printer attachment methods” on page 15.

9.2.1 Configuring an AS/400 printer to Windows 95

This example shows all the necessary steps to configure an AS/400-attached printer to Client Access for Windows 95/NT. Windows 95 was used for this example.

1. Start the **Add Printer** wizard. The wizard can be started in several ways, for example:
 - Open the folder **My Computer->Printers**, and double-click the **Add Printer** icon.
 - Click **Start->Settings->Printers**, and double-click the **Add Printer** icon.
2. The Add Printer Wizard window is shown. On this window, click **Next**. The window shown in Figure 135 appears.



Figure 135. Defining the attachment method of the printer

3. Click the **Network printer** radio button, and then click **Next**. The window shown in Figure 136 appears.

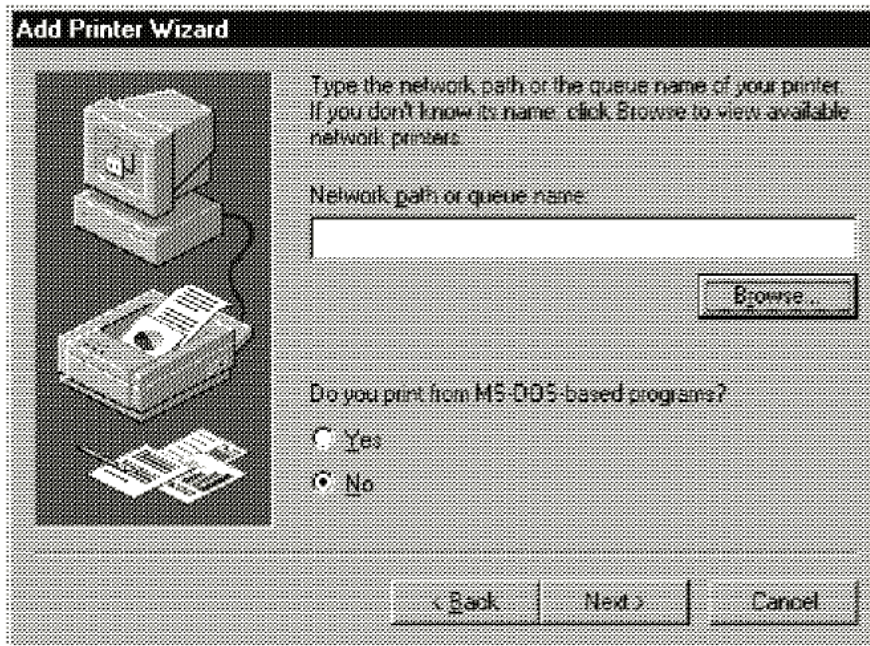

Figure 136. Network path or queue name

4. Click **Browse** to find the AS/400 system to which the printer is attached. The window shown in Figure 137 on page 188 appears.

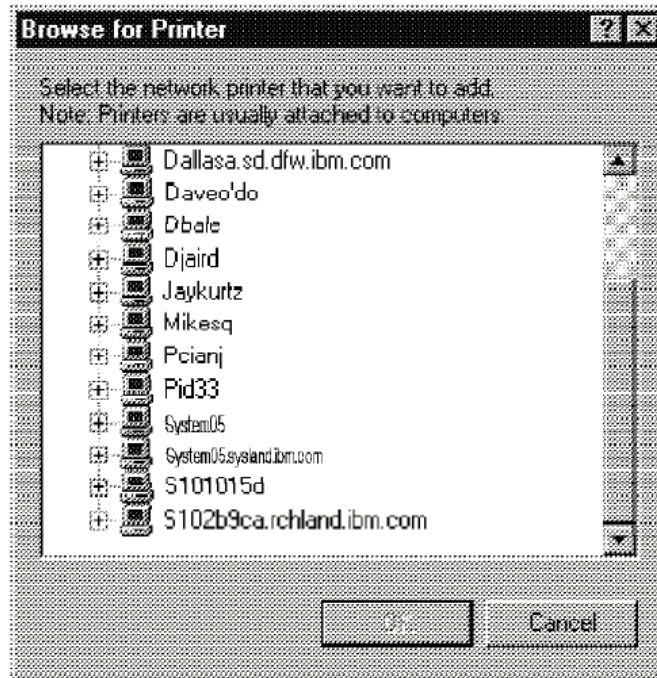

Figure 137. Browse for Printer (Part 1 of 2)

5. On the Browse for Printer window, select the AS/400 system by clicking the + (plus) sign. The list of the printers attached to the selected AS/400 system as shown in Figure 138 appears.

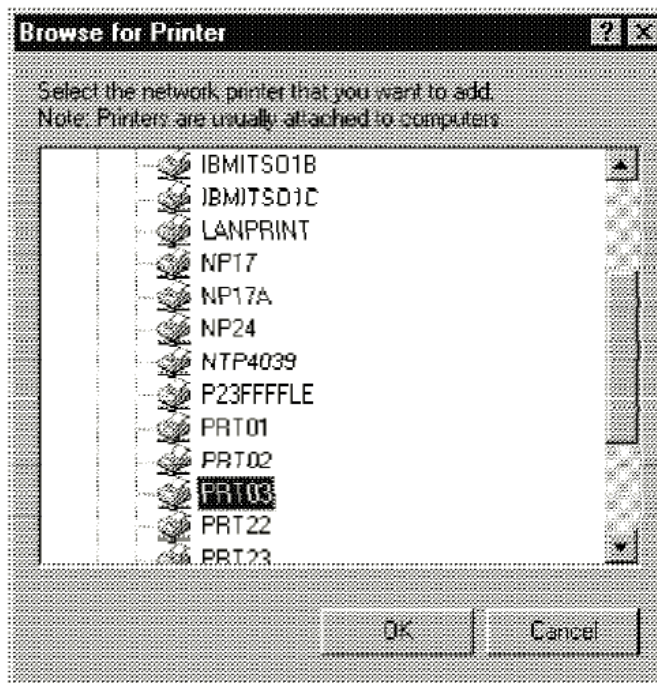

Figure 138. Browse for Printer (Part 2 of 2)

6. Select the printer you want to use, and click **OK**.

Note: Instead of browsing the network, you can directly enter the network path or queue name. In this case, enter one of the following options:

```
\\Systemname\Printername  
\\Systemname\Printername;Profilename  
\\Systemname\OutqueueLibraryname/Outqueue  
\\Systemname\OutqueueLibraryname/Outqueue;Profilename
```

7. The Add Printer Wizard window (Figure 139) shows the path to the printer. Click **Next**.

Note: If you do not need to print from DOS-based programs, click **Next**. Otherwise, click **Yes**. For the **Capture Printer Port**, select the LPT port. Then, click **OK** and **Next**. This is only necessary when a PC application cannot print directly to a Windows 95/NT printer driver.



Figure 139. Path to the printer

8. The window now lets you choose the manufacturer, type, and model of the printer (Figure 140 on page 190). When selected, click **Next**.

Note: These drivers need to be installed in Client Access. If they are not there, use Selective Install via Client Access to install them.

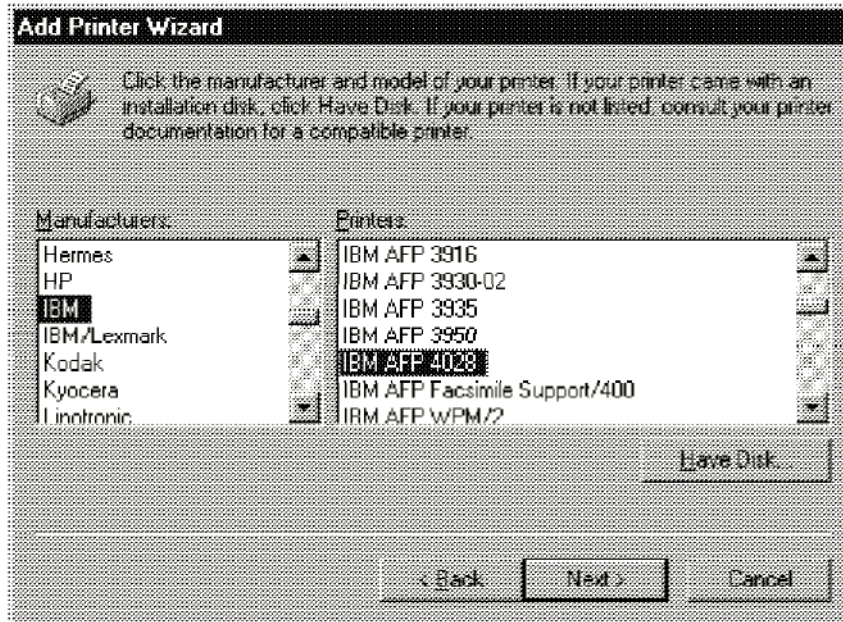

Figure 140. Manufacturer and model of the printer

9. On the window shown in Figure 141, confirm the supplied printer name or change it. Also, specify if you want to use it as default printer for the Windows applications. The default value is "No". Then click **Next**.

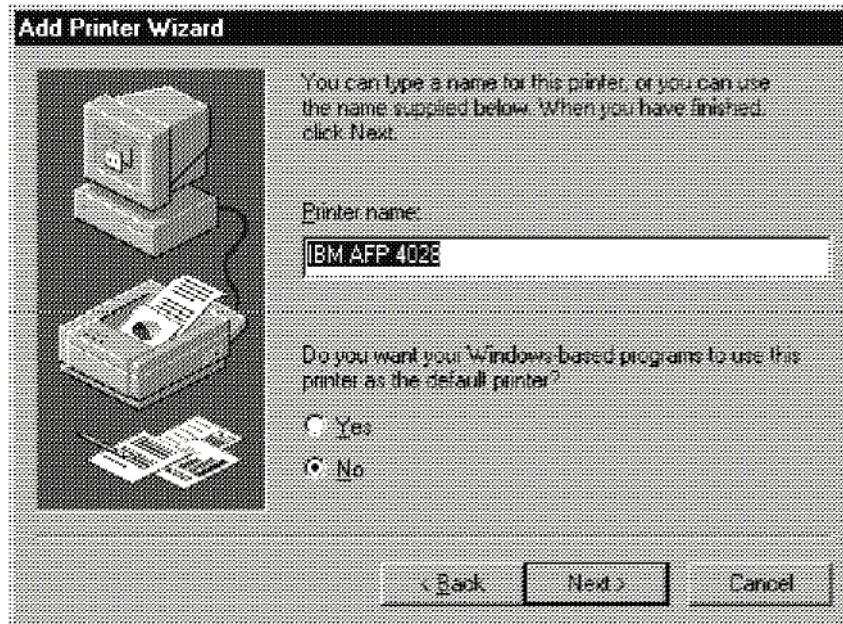

Figure 141. Installing as a default printer

10. The Add Printer Wizard window displayed allows you to print a test page on the selected printer. To print it, click **Finish**.
11. Then you see a window asking you if the test page printed correctly. Click **Yes** or **No** depending on the output received. This ends the configuration.

9.2.2 Network printer setup

Once you have installed a network printer with the default options, you may need to configure it further. The following example was performed using Client Access/400 for Windows 95/NT Version 3 Release 1 Modification 3 with Windows 95:

1. Right-click the printer icon, and select **Properties** from the pop-up menu.
2. On the General page, you can enter a comment that is visible when you share the printer with other users and when they set up your printer. You can also print a test page from there.
3. The Details page of the printer properties notebook (Figure 142) is mainly used to select a driver. Choose or configure the port, and set the spooling options.

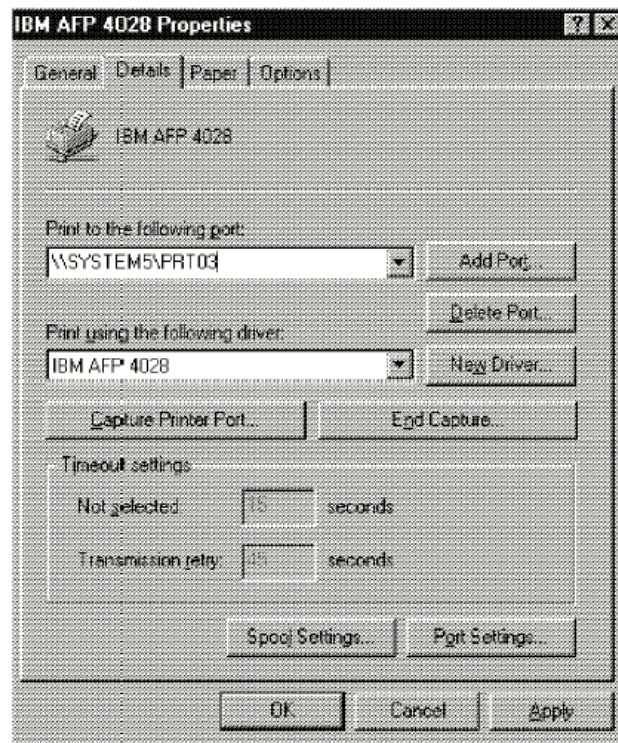

Figure 142. Printer properties: Details page for Windows 95

4. The last page of the properties notebook is labeled Options (Figure 142). On this page, you can define the AFP driver options. See Chapter 5, “The IBM AFP Printer Driver” on page 117, for detailed information on the AFP driver.

9.2.3 AS/400 print profile

The following example, based on Client Access/400 for Windows 95/NT Version 3 Release 1 Modification 3 with Windows 95, shows the steps required to add or change an AS/400 print profile:

1. Select the **Client Access** icon, and then the **Client Access Properties** icon. On the Client Access Properties window, select **Printer profiles**.
2. On the Printer Profiles windows, you can add a new profile or modify an existing one (for example, the Default AS/400 Print Profile).

Click **Add**, or select an existing profile and click **Change**. In this case, the window shown in Figure 143 appears.

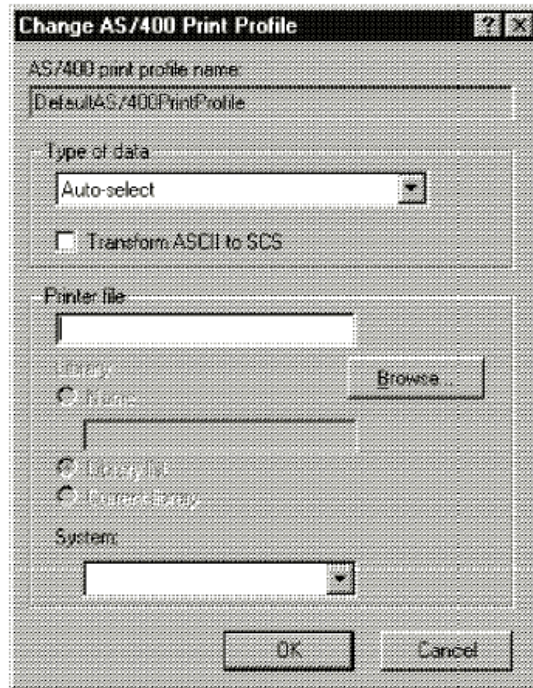

Figure 143. Adding an AS/400 print profile

3. On the Change or Add AS/400 Print Profile, you can specify the following values:
 - a. Type a descriptive name for your profile if you are in the Add AS/400 Print Profile window.
 - b. The Type of data parameter allows you to specify in which data stream the data is sent to the AS/400 system. You can select one of the following options:
 - **Auto-select**: The data type is automatically selected.
 - **Use printer file**: The data type specified in the DEVTYPE (Device Type) parameter of the default or user-specified AS/400 printer file is used. In this case, the DEVTYPE parameter must be *SCS, *AFPDS, or *USERASCII.
 - **SCS**: A spooled file of type *SCS (SNA Character String) is generated.
 - **AFPDS**: A spooled file of type *AFPDS (Advanced Function Printing Data Stream) is generated.
 - **User ASCII**: A spooled file of type *USERASCII (User ASCII) is generated.

Considerations on data type selection

- If your target printer is an ASCII printer, specify `User ASCII`. This will avoid any further transformations.
- If the application output is graphical (such as output from Microsoft Word, AmiPro, Freelance) and must be printed on an IPDS printer configured AFP(*YES), specify data type AFPDS.

Note: Even if host print transform can transform AFPDS to ASCII, specify `User ASCII` if the target printer is an ASCII printer.

- If the application output is text only, specify data type SCS if the target printer is SCS or IPDS configured AFP (*YES) or (*NO).

Note: Even if host print transform can transform SCS to ASCII, specify `User ASCII` if the target printer is an ASCII printer.

Table 17 may help you choose the correct type of data.

Table 17. Recommended data types and drivers

Output type	Target printer	Type of data (AS/400 print profile)	Printer driver (properties)
Text or Graphics	ASCII printer	User ASCII	Windows printer driver
Text	SCS or IPDS AFP(*YES) or (*NO)	SCS	IBM SCS xxxx Driver
Graphics	IPDS AFP (*YES)	AFPDS	IBM AFP xxxx Driver

- c. Select the **Transform ASCII to SCS** box if you have a file containing ASCII data that you want to print on an SCS printer.

The Transform ASCII to SCS option is a simple ASCII to EBCDIC conversion with some basic SCS commands such as carriage return and line feed. It was designed to print text and cannot handle graphics.

- d. The printer file used on the AS/400 system can be specified or changed. You can use the Browse button to search the AS/400 system for the printer file.

9.2.4 Considerations on Client Access/400 Network Printing

Redirecting printed output from PC applications to the AS/400 system has a number of benefits for PC users:

- The ability to use powerful OS/400 spool management functions such as printing a page range or saving the spooled file after printing.
- Use of powerful high speed printers, including IPDS printers with full error recovery functions to avoid data loss.
- Producing output in the device independent AFP data stream for printing and archiving.
- Using standard company wide AFP resources such as overlays and page segments.

9.3 Printing AS/400 output on a PC printer

An AS/400 application generates an SCS, IPDS, or AFPDS data stream for printing. Because PC connected printers are ASCII printers that support data streams such as PPDS, PCL/3 or PCL/5, the spooled files produced by AS/400 applications have to be transformed to the appropriate data stream for the PC printer.

Note: AS/400 IPDS spooled files cannot be transformed into ASCII.

There are three ways to achieve this conversion:

- OS/400 host print transform:

The transformation takes place on the AS/400 system; SCS and AFPDS spooled files can be converted. Customization is possible by modifying the Workstation Customizing (WSCST) object. The same WSCST object is used for all printers of a similar type.

- PC5250 emulation based on a Windows printer driver:

The transformation takes place on the PC, and only SCS spooled files can be converted. No customization is possible.

- PC5250 emulation using Printer Definition Tables (PDT):

The transformation takes place on the PC, and only SCS spooled files can be converted. Printer functions can be adapted by modifying the Printer Definition Table (PDT). The modified PDT must be available on all PCs using the printer.

The following sections include configuration examples. The environment we used was:

- Windows 95
- Client Access for Windows 95/NT Version 3 Release 1 Modification 3
- OS/400 Version 4 Release 2
- Automatic configuration of devices on the AS/400 system were turned on. Using automatic device configuration, the printer device description is based on the configuration on the PC. Any changes made to the device description manually on the AS/400 system are overwritten when the session is started on the PC. Parameters not sent by the PC are kept, by the host, such as Image Object name. This is a reason to use a unique workstation ID, which is also the device description file name.

Note: Before a printer emulation session can be configured, at least one printer must be defined to Windows.

9.3.1 Configuring a printer emulation session

This example describes how to configure a printer emulation session for use with or without the host print transform function. It assumes that you have already configured a Client Access connection to the AS/400 system via SNA or TCP/IP. Client Access Version 3 Release 1 Modification 3 allows native TCP/IP printer emulation sessions in addition to SNA.

1. Start the configuration program by selecting the **Start or Configure Session** icon in the Client Access Accessories folder.

A welcome window is shown. Click **OK**. A window appears like the one shown in Figure 144.

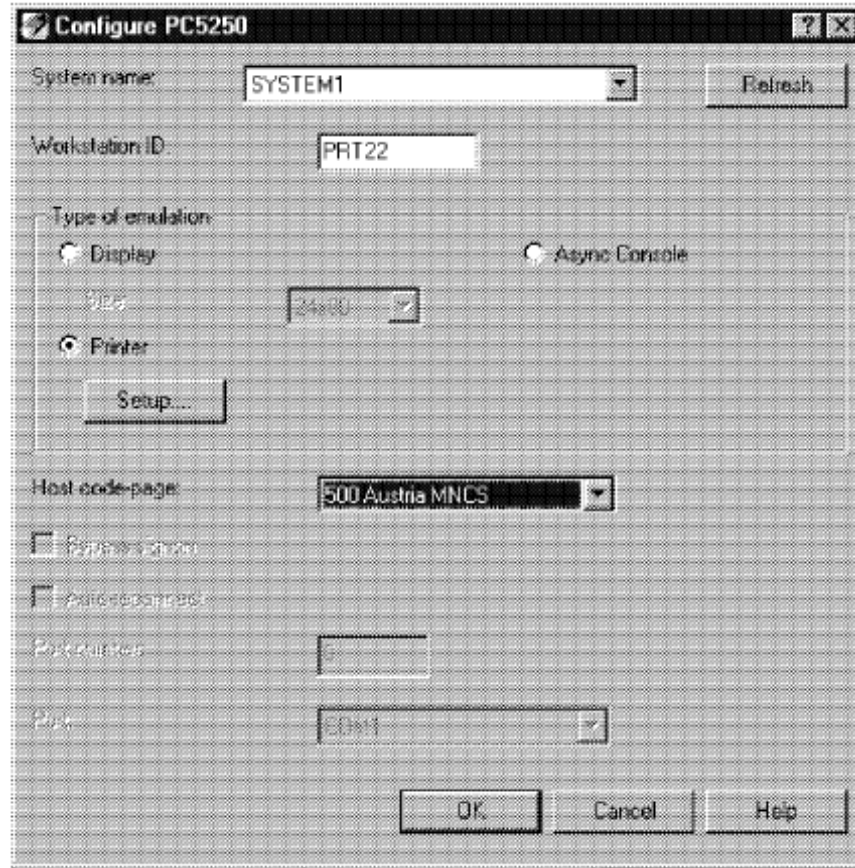

Figure 144. Configuring IBM Personal Communications 5250

2. On the Configure PC5250 window, complete these steps:
 - a. Select the AS/400 system.
 - b. Select the **Printer** option for Type of emulation.
 - c. A name for the printer (workstation ID) can be given. This name appears on the AS/400 system as the printer device name and output queue name.
Note: If this field is left blank, an ID based on the currently active session number is given when establishing the session.
 - d. Select the **Host code-page** used. This information is used to transform the EBCDIC characters sent from the AS/400 system to the corresponding ASCII code points.
 - e. Click **Setup** to continue. A window appears like the example shown in Figure 145 on page 196.

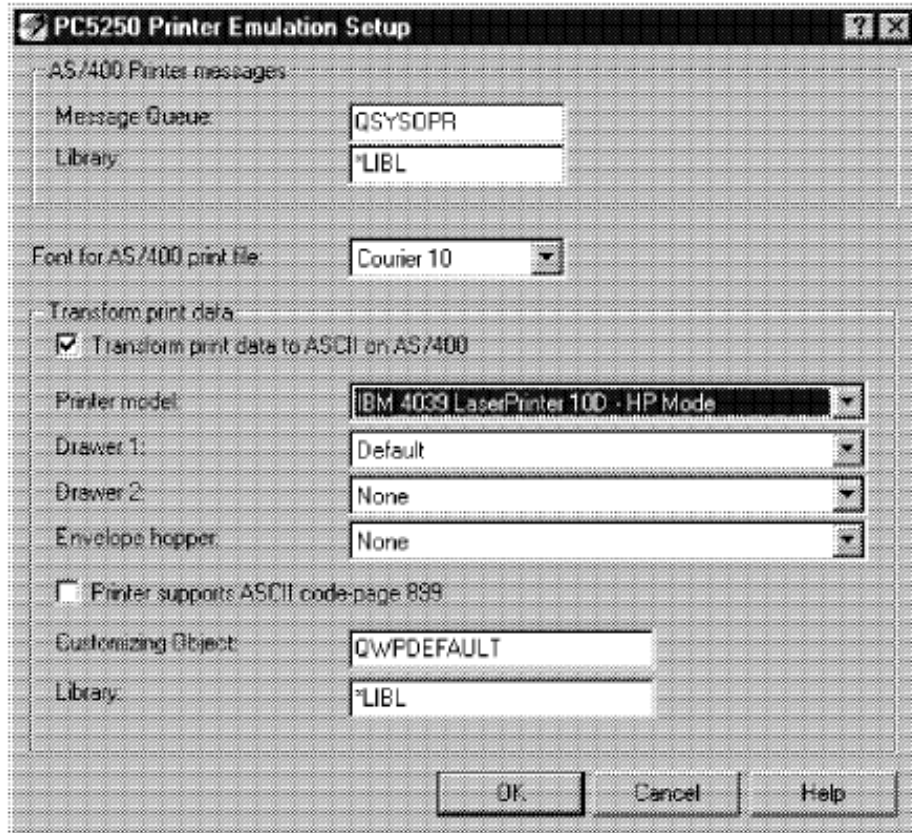

Figure 145. Printer emulation setup with host print transform

3. On the PC5250 Printer Emulation Setup window, specify:
 - a. The AS/400 message queue to be used with the library name.
 - b. The Courier 10 font is used if FONT(*DEV D) is specified.
 - c. If you want to have the data stream conversion done by PC5250 rather than by the OS/400 host print transform function, skip substeps d through h.
 - d. Select the **Transform print data to ASCII on AS/400** box.
 - e. Specify a printer model.
 - f. Specify a paper size for drawer 1, drawer 2, and envelope hopper.
 - g. Do not select Printer supports ASCII code page 899 (this code page is not standard on ASCII printers, and usually requires a special font cartridge).
 - h. Leave the default value for Customizing Object and Library.

This results in a device description on the AS/400 system with the following parameters values:

```

DEV D      PRT22
DEVCLS    *VRT
TYPE      3812
AFP       *NO
CTL       QVIRCD0001
FONT      011
TRANSFORM *YES
MPRTYPMDL *IBM4039HP
WSCST     *NONE
  
```

If the use of a workstation customization table is required, select **Other Printer** as the Printer model and specify the name of your customized WSCST object in the Customizing Object field and the library name. This results in the following parameter values in the printer device description:

```

DEVD          PRT22
DEVCLS        *VRT
TYPE          3812
AFP           *NO
CTL           QVIRCD0001
FONT          011
TRANSFORM     *YES
MFRTYPMDL    *WSCST
WSCST         MYWSCST <--- The name of your customized object
                *LIBL

```

Note: If both WSCST and a printer model are specified, the workstation customizing object is ignored. We recently changed this to allow any of the WSCSTLETTER and other WSCST* objects, which indicate the paper type to be used with the Customization Object specified. The *OTHER object is no longer allowed.

4. Click **OK** to return to the previous window.
5. Click **OK** to start the printer emulation session. Windows appear, such as the examples shown in Figure 146. The printer can be started or stopped from this window.

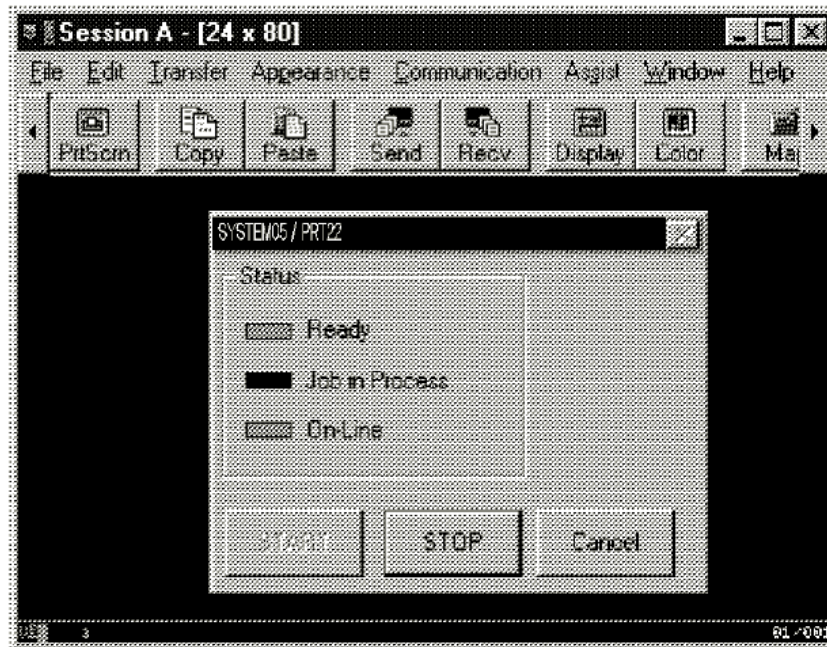

Figure 146. Printer session window

6. To save the session and create an icon, click **File** and **Save as...**. The window shown in Figure 147 on page 198 appears.

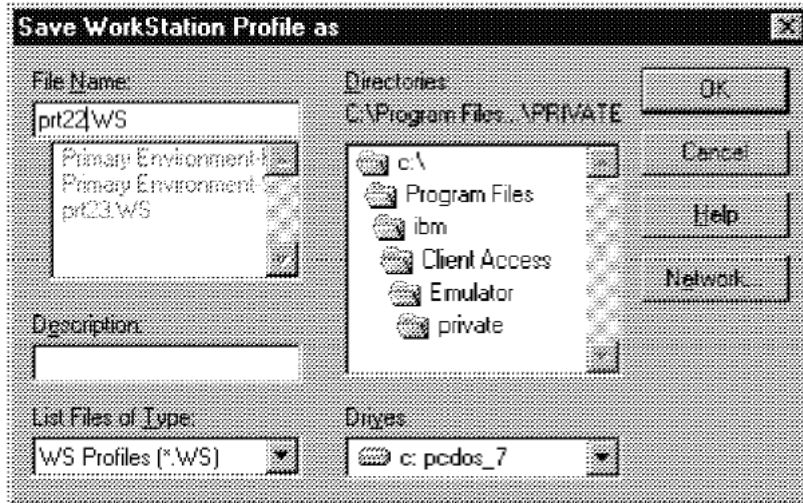

Figure 147. Save Workstation Profile as

7. Enter a name for the configuration file (in this example, PRT22), and click **OK**. The window shown in Figure 148 appears.

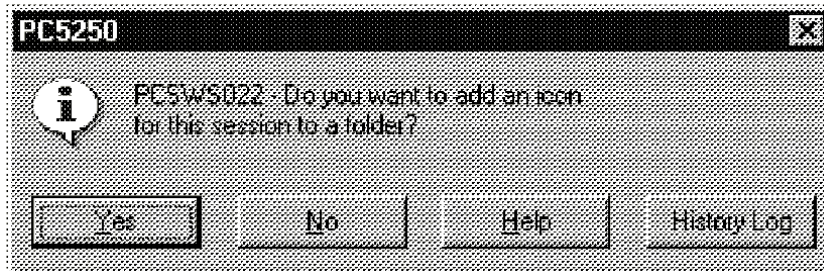

Figure 148. Create printer session icon

8. Click **Yes** to create an icon for the printer session. The Browse for Folder window shown in Figure 149 appears.

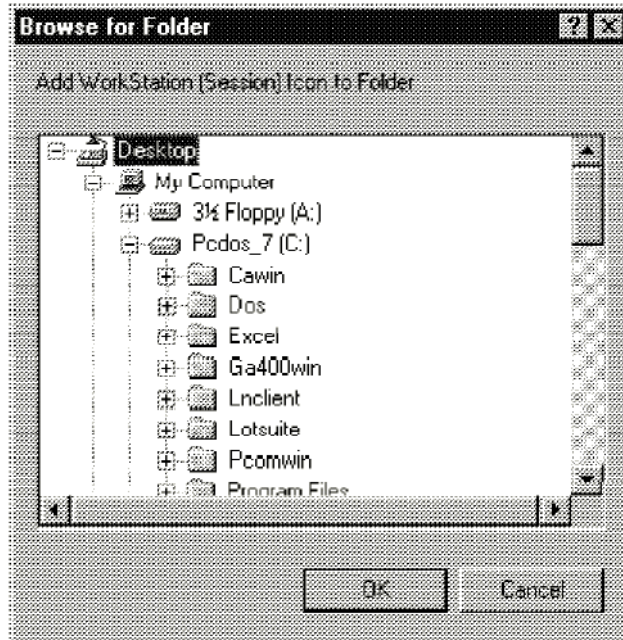

Figure 149. Selecting a destination for the icon

9. Click the destination (folder/desktop) where the icon should be placed, and click **OK**. The window shown in Figure 150 appears.

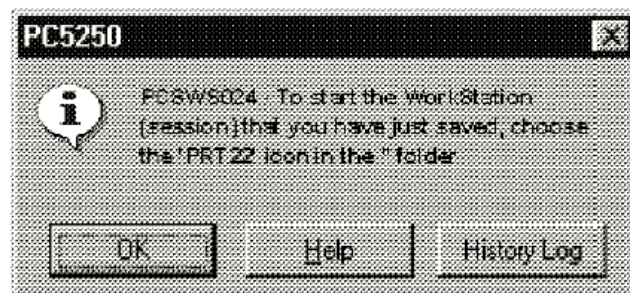

Figure 150. Icon information

10. Click **OK** to create the icon.
11. Now a printer defined to Windows can be connected to this session. Click **File** and **Printer Setup** from the printer emulation session window. The window shown in Figure 151 on page 200 appears.

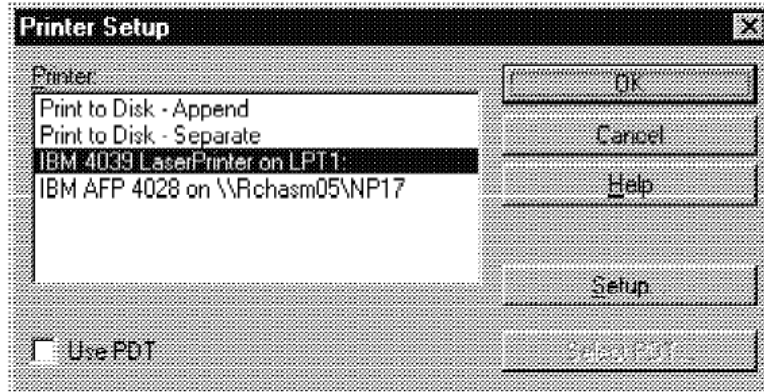

Figure 151. Selecting a printer

12. Click the printer you want to use, and then click **OK** to end the configuration.

Note: If no printer is connected with a printer emulation session, the Windows default printer is used, and the window shown in Figure 152 appears.



Figure 152. Using the default printer

9.3.2 Modifying and using a printer definition table (PDT)

This example assumes that a printer emulation session is already configured and working. For a description of how to configure a printer emulation session, follow the instructions in 9.3.1, “Configuring a printer emulation session” on page 194, and do not specify host print transform.

Printer definition tables (PDTs) can be used to override host formatting (done through the SCS commands), or to initialize the printer independent of the SCS formatting. The steps to modify one are:

1. Create or change a printer definition file (PDF).
2. Convert the printer definition file to a printer definition table.

PDFs can be modified with any editor on your PC. They consist of macro definitions that specify how to convert the SCS code to ASCII strings. Many PDFs and PDTs come with Client Access. More details and a list of functions available can be found in the *Client Access/400 Personal Communications 5250 Reference Guide*, SC41-3553.

The following example shows how to change a PDF, create the PDT, and how to configure the PC5250 session to use the PDT:

1. Select a printer definition file for modifying. In most cases, an existing PDF is selected for modification. The PDF, which is closest to the functionality of the physical printer used, should be copied and then edited. In this example, the HPLJ4.PDF file has been copied to the I4039HP.PDF file. The path for the PDF files for a default Client Access installation is:

```
\program files\ibm\client access\emulator\pdfpdt
```

You can search for the PDF files in a separate subdirectory named PDFPDT.

```

/*****
/*
/*      PRINTER SESSION DEFINITION FILE FOR: HP LaserJet 4      */
/*
/*****
BEGIN_MACROS
NUL          EQU 00          /* Nul character          */
BAK          EQU 08          /* Back Space            */
TAB          EQU 09          /* Tab                   */
LFF          EQU 0A          /* Line Feed             */
FFF          EQU 0C          /* Form Feed             */
CR          EQU 0D          /* Carriage Return      */
P12          EQU 1B 26 6B 34 53 /* 12 Pitch-Characters/Inch */
P10          EQU 1B 26 6B 30 53 /* 10 Pitch-Characters/Inch */
ESC          EQU 1B          /* Escape                */
SPA          EQU 20          /* Space                 */
P17          EQU 1B 26 6B 32 53 /* 16.7 Pitch-Characters/inch */
CS1          EQU 1B 28 38 55 /* Roman 8 char set 1   */
CS2          EQU 1B 29 38 55 /* Roman 8 char set 2   */
EC1          EQU 1B 28 35 4D /* PS Math Symbol Set   */
EC2          EQU 1B 29 30 4E /* ECMA-94 Latin 1 char set 2 */
PC1          EQU 1B 28 30 4E /* PC-8 (IBM US) char set 1 */
PC2          EQU 1B 29 30 4E /* PC-8 (IBM US) char set 2 */

.....
.....

NOR          EQU 1B 45          /* Normal background-foreground*/
SFG          EQU 1B 28 73      /*
END_MACROS

/*****
/*
/*      Session Parameters      */
/*****
MAXIMUM_PAGE_LENGTH=060          /* Printed lines per page      */
MAXIMUM_PRINT_POSITION=080      /* Printed characters per line */
INTERV_REQ_TIMER=001           /*
HORIZONTAL_PEL=0720            /*

.....
.....

MIDDLE_DOT_ACCENT = B7
ONE_SUPERSCRIPT = B9
NUMBER_SIGN = 70
THREE_SUPERSCRIPT = B3
TWO_SUPERSCRIPT = B2
REQUIRED_SPACE = 20

/*****
/*
/*      Internal Data Area.      */
/* Do not change these statement. */
/*****
PRINTER_ID=99 99
/*****
/*
/*      End of Definition File      */
/*****

```

Figure 153. I4039HP.PDF table (partial)

In the example shown in Figure 153, we made two changes to the PDF:

- The following line:

```
EC1 EQU 1B 28 30 4E /* ECMA-94 Latin 1 char set 1 */
```

has been changed to:

```
EC1 EQU 1B 28 35 4D /* PS Math Symbol Set */
```

to use the *PS Math Symbol Set* instead of the *Latin 1 Symbol Set*.

- The following entry:

```
NUMBER_SIGN=23
```

has been changed to:

```
NUMBER_SIGN=70
```

to print the mathematical symbol “Pi” instead of the number sign.

2. Convert the PDF to a PDT

Select **File** from the pull-down menu of the printer emulation session. Then select **Printer Setup**, and the window shown in Figure 154 appears.

Note: Converting a PDF to a PDT can be done from any emulation window. In this example, we are going to use the converted PDT with the printer emulation session, so we do the conversion from that emulation session.

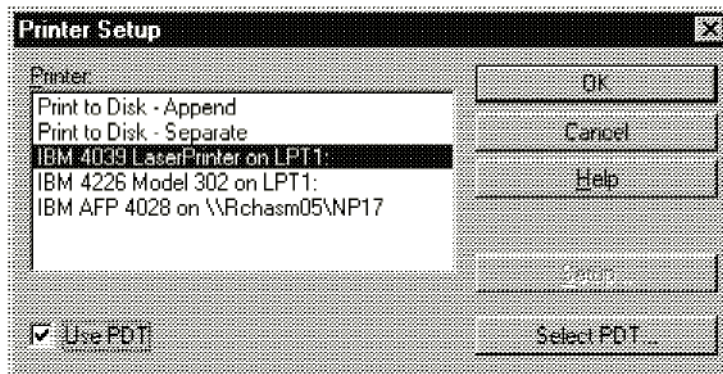

Figure 154. Printer Setup window

3. Select the **Use PDT** box, and click **Select PDT...** The Select PDT file window shown in Figure 155 appears.

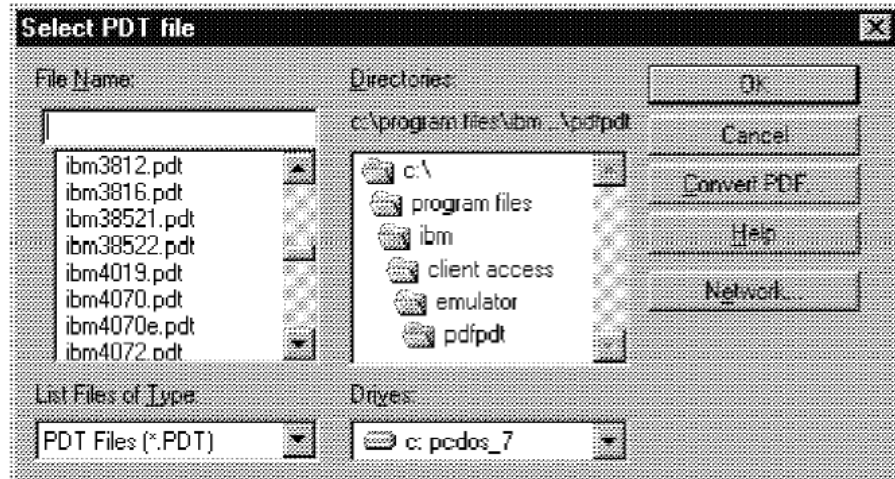

Figure 155. Select PDT file

4. Click **Convert PDF...**, and the Convert PDF to PDT window shown in Figure 156 appears.

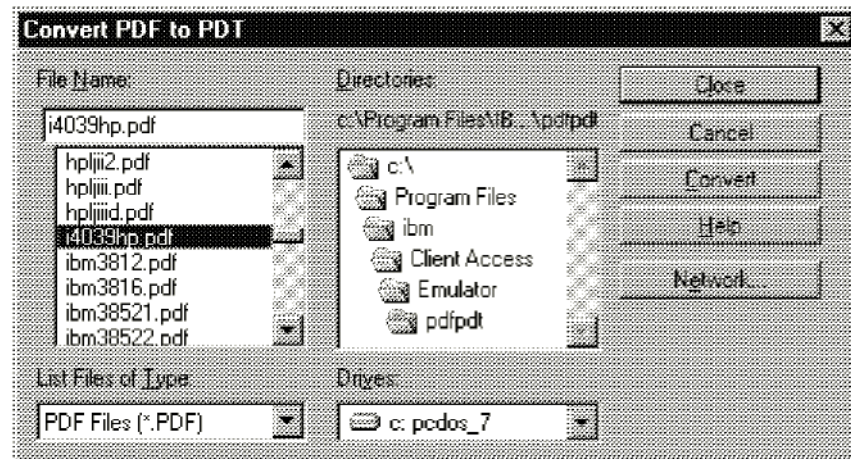

Figure 156. Convert PDF to PDT

5. Select the modified PDF, and click **Convert**. The PDF File Converter window shown in Figure 157 on page 204 appears.

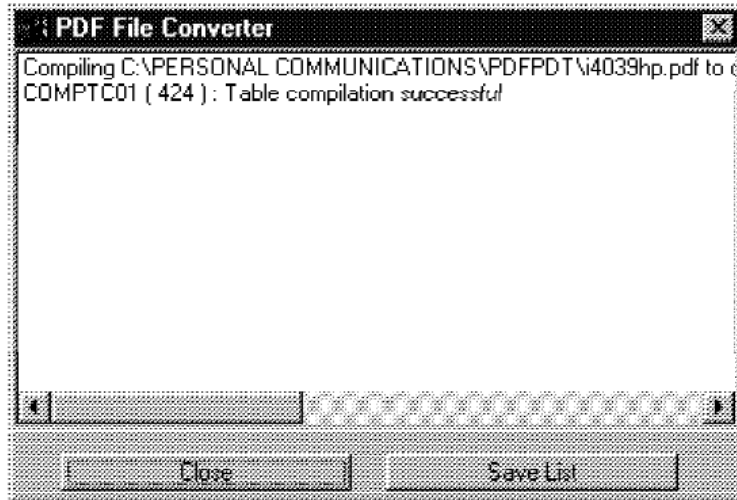

Figure 157. PDF File Converter

6. If compilation is successful, click **Close**, and the Convert PDF to PDT window is shown again.
7. On the Convert PDF to PDT window, click **Close**, and the Select PDT File is shown. The converted PDT is highlighted. Click **OK**, and the Printer Setup window is shown.
8. On the Printer Setup window, click **OK** to end the configuration.

Note: It is not necessary to restart the session with the AS/400 system. The newly converted PDT takes effect immediately.

Chapter 10. IBM AS/400 network printers

There is a wide range of IBM AS/400 network laser printers. The current printer line includes:

- IBM Network Printer 12
- IBM Network Printer 17
- IBM Infoprint 20
- IBM Infoprint 21
- IBM Infoprint 32
- IBM Infoprint 40
- IBM Infoprint Color 8

This chapter explains how you can maximize printer effectiveness when it is attached to an AS/400 system. IBM Network Printer 17 was used for this illustration, but the highlighted features generally apply to all the monochrome network printers.

Note: For the latest setup and configuration reference, click the **Publications** link at: <http://www.ibm.com/printers>

10.1 Overview

There are a number of shared characteristics that make IBM AS/400 network printers a good choice for AS/400 and network environments, including:

- 600 and 1200 dpi resolutions
- Multiple active physical attachments
- Data stream auto-sensing
- Writer sharing to switch between network clients and servers, and AS/400 writers

The newest member of the IBM AS/400 network printer family is IBM Infoprint 21. This printer adds several important additional features that are key to printing in a network environment, including:

- It supports Internet Printing Protocol (IPP), which enables you to reference and print to a printer via a URL.
- An embedded Web server within the printer enables access to the printer from any Web client. This provides the capability to view printer information and to manage the printer directly from any Web browser.
- IBM Homerun printer controller provides the capabilities of the Advanced Function Common Controller (AFCC) used in much larger IBM AS/400 printers.

IBM AS/400 network printers make ideal workgroup, distributed, or small system printers within AS/400 network environments. An overview of the principal supported attachments, protocols, and data streams is shown in Figure 158 on page 206.

Although they may be attached using conventional means, such as twinaxial cable or parallel cable, their greatest flexibility is realized when they are TCP/IP LAN-attached. When installed on a Token-Ring or Ethernet LAN, they can receive data from a variety of host systems as well as PC clients on the LAN. Network

management software, in the form of IBM Network Printer Manager, may be used to monitor and maintain the printers, either across the LAN or through the World Wide Web. This is discussed in 10.4.1, "Network Printer Manager" on page 215.

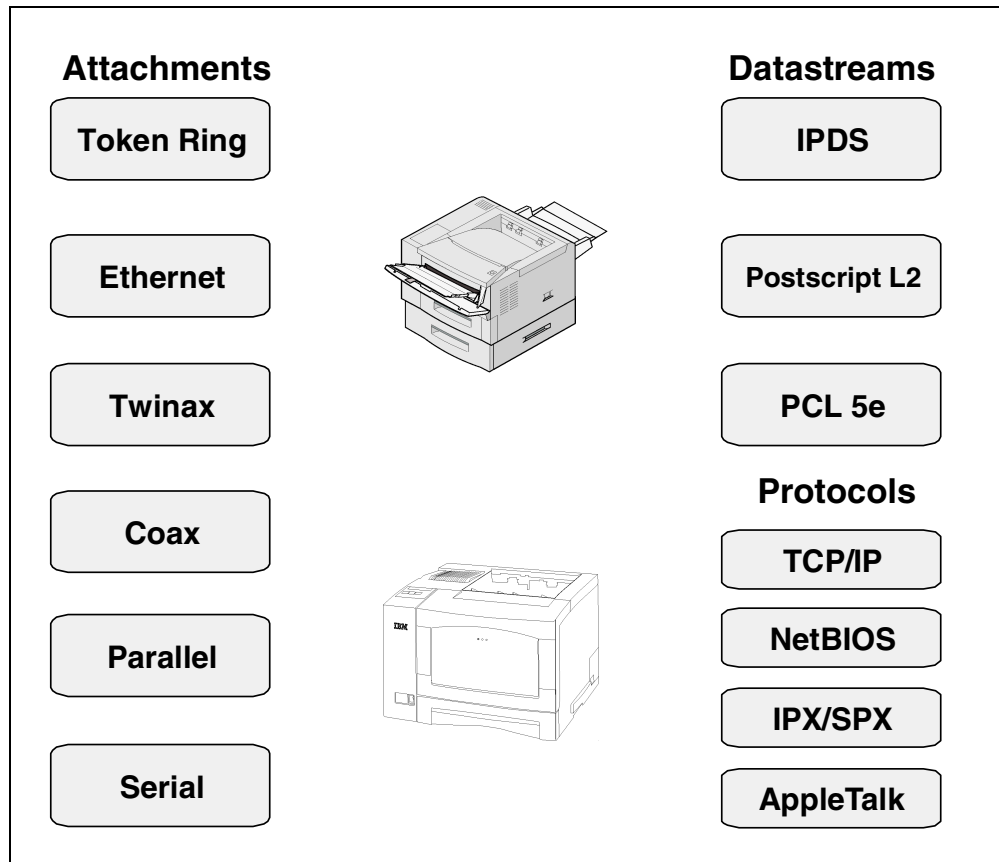

Figure 158. Network printer connectivity

10.2 Configuration scenarios

This section outlines simple and advanced uses of network printers.

10.2.1 Example 1: LAN-attached IPDS printer

Here an NP17 has been attached to an AS/400 system through Ethernet (Figure 159). The printer is used in the Accounting department of a business, printing variable data with electronic forms (overlays) sent with the data from the AS/400 system. The printer is configured as type *IPDS, AFP=*YES.

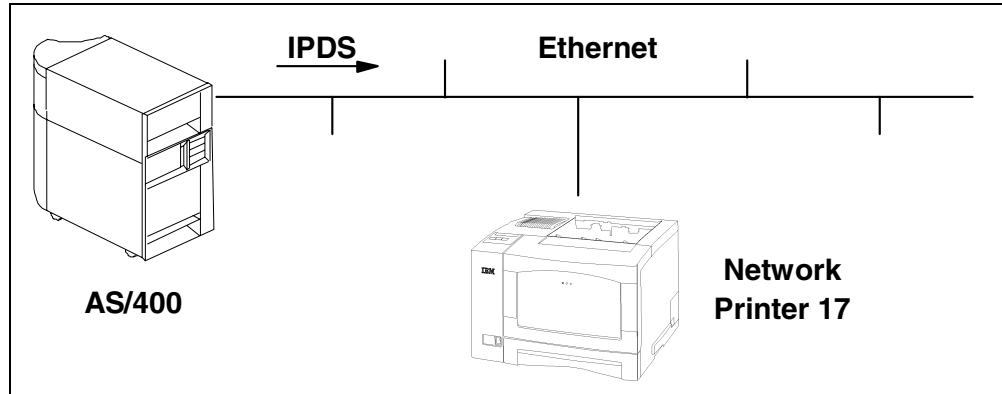

Figure 159. LAN-attached Network Printer 17

10.2.2 Example 2: Dual-configuration printer

This example shows the same physical printer, but a second logical device has been configured on the AS/400 system (Figure 160). This second device is configured as a LAN-attached ASCII printer and receives only the PCL data stream. The reason this has been done is because the printer is now being used for general purpose office printing such as reports, screen prints, and program listings. Although these can be sent to the IPDS device, it is quicker to send such simple documents using a PCL device description. The printer has been set up to *automatically* switch between the two operating modes. This is indicated on the printer's operator panel (PCL ETHERNET and IPDS ETHERNET) so users know which particular type of output is being printed.

The second device is configured as an emulated 3812 Model 1 with LAN attachment *IP. This configuration is available at Version 3.0 Release 7.0 and later. Prior to this, we can use a remote output queue for a similar effect. These types of configuration are discussed in 1.4, "AS/400 printer attachment methods" on page 15.

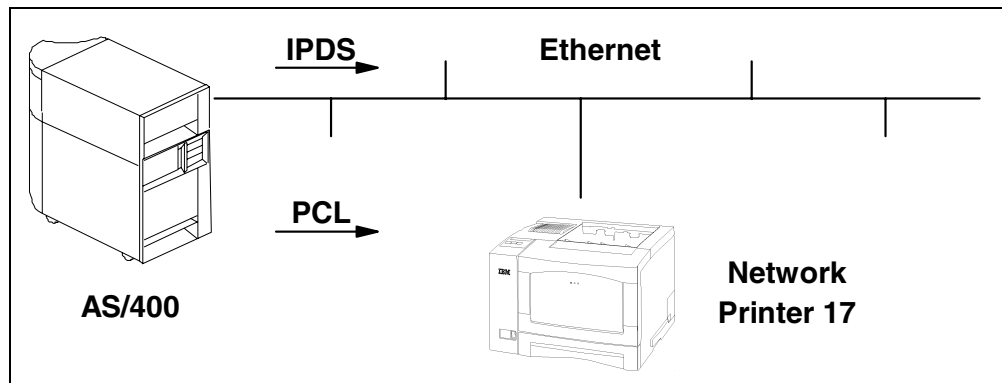

Figure 160. Single LAN-attached Network Printer 17: Two logical devices

10.2.3 Example 3: Shared dual-configuration printer

In this example, in addition to the dual-configuration use made by a single AS/400 system. A second AS/400 system also directly uses the printer. Again, the printer

manages the switching between the two different hosts as it does for switching between data streams (Figure 161).

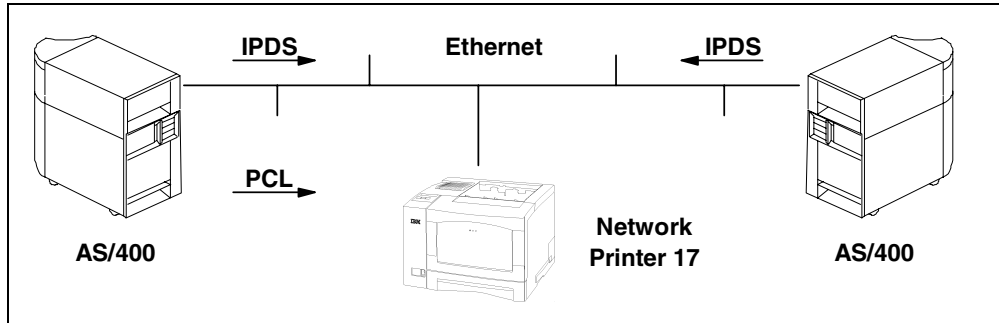

Figure 161. Shared Network Printer 17

10.2.4 Example 4: Shared multi-purpose printer

We can continue to extend the versatility of the network printer by adding options such as a Token-Ring adapter, an envelope feeder, two 500-sheet input bins, and an offset stacker/jogger output bin. Users on the Token-Ring LAN can now send PCL or PostScript jobs to the printer, perhaps using the offset stacker for e-mail, spread sheets, and other PC documents. The PCs can be on a Windows NT server in Figure 162, but can also be on an OS/2, Novell NetWare, or Apple network. They might also use the existing Ethernet adapter instead of Token-Ring.

Alternative options might be a 10-bin mailbox feature in place of the offset stacker for printing confidential personnel records, a Twinax adapter instead of one of the LAN adapters, or even a higher-throughput NP24 to cope with even more traffic!

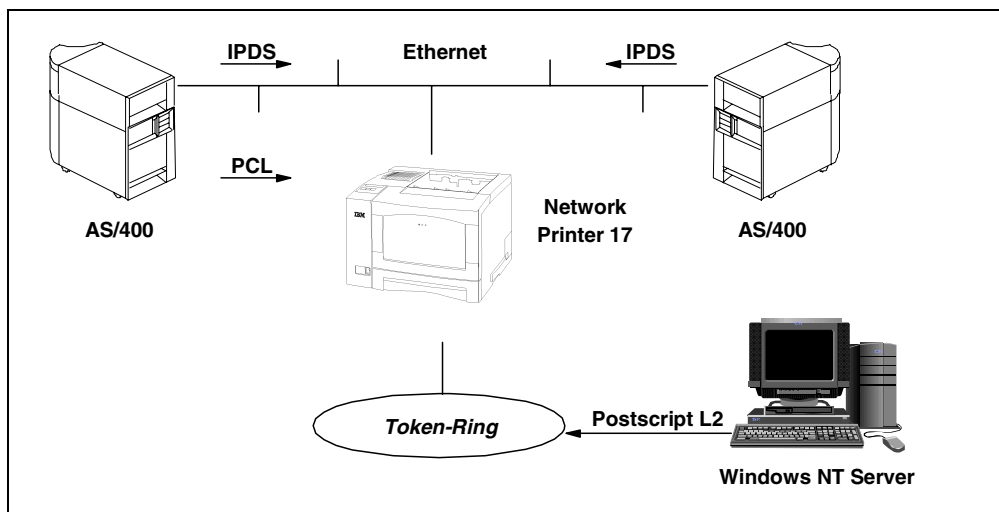

Figure 162. Shared Network Printer 17 with options

These examples show how network printers may be installed in an initially simple manner to satisfy one particular requirement, yet grow with the demands of the enterprise.

10.3 Printer setup

Each model of the Network Printer is shipped with the following manuals:

- *User's Guide*
- *Quick Set-up*
- *Safety Information*

The publication numbers of the manuals vary by language. In addition, the following publications are shipped when the appropriate attachment options are purchased:

- *Twinax/Coax Configuration Guide*, G544-5241
- *Ethernet and Token-Ring Configuration Guide*, G544-5240
- *Ethernet and Token Ring Configuration Guide (Infoprint 21)*, S544-5711

The following publications are available for purchase in hardcopy format:

- *IPDS and SCS Technical Reference*, S544-5312
- *PCL5e and PostScript Technical Reference*, S544-5344

They are also freely available on the World Wide Web at:

<http://www.printers.ibm.com/manuals.html>

This redbook is not a substitute for any of these publications. Use the shipped manuals for unpacking and basic setup (for example, installing the toner cartridge, loading paper, and using the operator panel). Use the optional attachment guides to attach the printer to the system.

10.3.1 Printer menu details

To print out the Configuration Page for any of the monochrome models, ensure the printer display shows READY. Then press the following keys in sequence: **Online->Menu->Item->Enter**. If the printer does not show READY, but shows the status of the last job (for example, IPDS ETHERNET), not all the menu printout options are available.

The following values are the settings that we recommend for the menus affecting host printing. IBM Network Printer 17 was used as an example. For other models, and for more detailed information, refer to the User's and Configuration Guides. Menu items are only listed here if they relate to host-based printing in some way, either directly or indirectly.

10.3.1.1 TEST MENU

Use this menu to print out the Configuration Page (see the preceding paragraphs) as well as listings of IPDS resident fonts.

10.3.1.2 PAPER MENU

This controls paper-handling when this is not specified by the host.

SOURCE TRAY 1

This is the default tray used when one is not specified in the data stream (for example, when printing a test page). However, if you want to use the auxiliary tray with host jobs, set SOURCE to AUX. This is explained in "Auxiliary tray" on page 213.

MANUAL OFF

This applies to paper feeding from the auxiliary tray. Set it to OFF (automatic feed) unless you are feeding special stationery, such as stiff card stock and want to feed these singly.

AUXSIZE LETTER or A4 or as required

You must specify the loaded paper size for the auxiliary tray since this tray does not have a paper size sensor.

10.3.1.3 CONFIG MENU

In the case of host printing, this only applies to an SCS data stream.

JAMRECOVERY ON

10.3.1.4 TOKEN RING and ETHERNET MENU

This menu is only present if a LAN feature (LAN NIC (Network Interface Card)) is installed.

PERSONALITY AUTO

PORT TIMEOUT 15

Other parameters vary according to your particular requirements (IP address and others).

10.3.1.5 TWINAX SCS MENU

This menu is only present if a Twinax feature is installed.

CODE PAGE The country code page of your system (037 - U.S., 285 - U.K., for example)

10.3.1.6 TWINAX SETUP MENU

This menu is only present if a Twinax feature is installed.

SCS ADR An address from 0 to 6

Must be different than the IPDS address. Set this address to OFF if you do not want an SCS-only device description for this printer.

IPDS ADR An address from 0 to 6

Must be different than the SCS address.

EDGE-EDGE ON

For Network Printers 12 and 17 only. This is contrary to the recommendation in the *User's Guide*, but you have more scope for defining applications that can extend to the edge of the page. Note that the setting in this menu applies to SCS printing only.

BUFFERSIZE 1024

This applies to IPDS printing only. The SCS buffer size is always 256 bytes.

PORT TIMEOUT 90

10.3.1.7 IPDS MENU

This menu is only present if the IPDS feature (IPDS SIMM (Single Inline Memory Module)) is installed.

PAGEPROT AUTO

DEF CD PAG The country code page of your system (037 - U.S., 285 - U.K., for example)

EMULATION 43xx.

Set this to native mode (43xx). Ensure you install on your system the program temporary fixes (PTFs) listed in Table 18 on page 212. Operating the printer in 4028 mode affects font substitution and twinax auto-configuration.

DEF FGID 416 (or any FGID of your choice)

CPI 10.0 (or any CPI to match your FGID choice)

VPA CHK ON

X OFFSET 0

Y OFFSET 0

PAGE WHOLE

This setting is explained in 10.5.5, "Using the IPDS menu PAGE setting" on page 218.

EDGE-EDGE ON

For Network Printers 12 and 17 only. This is contrary to the recommendation in the *User's Guide*, but you have more scope for defining applications that can extend to the edge of the page as well as greater compatibility with edge-to-edge printers such as the IBM 3130 and Infoprint 60. See 10.5.6, "Edge-to-edge printing" on page 221, for details.

FONT SUB ON

Note that the default is OFF.

IPDS PORT TRING (if Token-Ring attach), ETHER (if Ethernet attach), or TX (if Twinax attach).

If you have both LAN and Twinax adapters on the printer, only one may be active for IPDS support at any one time. This does not depend on the setting of the IPDS port, however.

Note: You cannot have a device using two IPDS ports simultaneously. For example, if you have a twinax adapter and a LAN adapter, only one may be active for IPDS at any one time. However, this does not prevent you from configuring both adapters for IPDS use. Despite the setting of this item, the port used for IPDS jobs simply depends on which port is activated first by the STRPRTWTR command (or equivalent command on a non-AS/400 system). You can even share IPDS traffic between the two ports using the PORT TIMEOUT option for each adapter (for example, if the printer is shared by multiple systems, one that uses twinax and the other uses LAN cabling).

EARLY COMPL OFF

This item only appears if a twinax adapter is also present. If this item is enabled, the printer sends back a good acknowledgement (ACK) when it has *received* the data, not when it has printed the data. This improves performance, but runs the risk of losing data (for example, through a paper jam). This is how the printer operates in SCS mode in any case, relying on features such as JAMRECOVERY=ON (in the CONFIG MENU) to reprint a page. Using EARLY COMPL=OFF in the IPDS implementation causes the printer not to send a good ACK until the completed output is in the output bin, together with the host IPDS data stream re-transmitting the page if required. Therefore, error recovery is improved.

10.3.2 Recommended PTF levels

The PTFs listed in Table 18 provide the correct PSF/400 support for the network printers in native mode (EMULATION set to 4312, 4317, or 4324 in the IPDS MENU). The PTFs also add support for the IBM 4247-001 impact printer. The *Ethernet and Token-Ring Configuration Guide*, G544-5240, may mention PTF SF33025 for V3R7. This PTF is now in the base operating system.

Table 18. PTF support for network printers in native mode (43xx)

Version and Release	APAR	PTF	Cumulative pack
V3R1	SA52845	SF43120	-
V3R2	SA52845	SF43431	7014
V3R6	SA55722	SF42712	-
V3R7 and later	Base Operating system		

10.3.3 Microcode

Microcode is the internal machine code that resides on the SIMMs and NICs. The Configuration Page may show code levels with an “R” or an “F” after the numbers. These indicate ROM or Flash SIMMs. It is only possible to download new levels of microcode to Flash SIMMs. If the SIMM type is not indicated, it is usually a Flash SIMM.

Customers may upgrade the code levels of LAN NIC cards using Network Printer Manager. Token-Ring and Ethernet microcode are available on the Web at:
<http://www.printers.ibm.com/util.html>

A service representative performs other code upgrades. In either case, this should only be done when advised by IBM Technical Support.

10.3.4 Tray and bin selection

This explains the settings required to select the auxiliary tray (an input tray) and the mailbox bins and offset stacker (output bins). Note that the terms *tray* and *bin* may be used synonymously in the documentation.

10.3.4.1 Input trays

Input tray selection is outlined in Table 19.

Table 19. Input tray selection

DRAWER parameter in printer file	FORMFEED parameter in printer file	Drawer name on printer
SCS printing		
1	*AUTOCUT	1
2	*AUTOCUT	2
3	*AUTOCUT	Auxiliary
any	*CUT	Manual Tray
E1	*AUTOCUT	Envelope Feeder
IPDS and AFP printing		
1	*AUTOCUT	1
2	*AUTOCUT	2
3	*AUTOCUT	3
any	*CUT	Auxiliary Tray (with MANUAL=OFF)
any	*CUT	Auxiliary Tray (with MANUAL=ON)
E1	*AUTOCUT	Envelope Feeder

Auxiliary tray

If you want to use the auxiliary tray with SCS jobs, but do not want to change printer files to specify *CUT on the FORMFEED parameter, use the following workaround:

1. Set the source tray in the PAPER MENU to AUX.

Note: This also results in the AUX tray being used for test pages and font listings.
2. Set AUXSIZE in the PAPER MENU to the paper size that is used (for example, LETTER or A4).
3. Set MANUAL in the PAPER MENU to OFF. Otherwise, you are prompted to load each piece of paper.
4. Set the IPDSPASTHR parameter in the PSFCFG Object to *NO.
5. In the printer file, specify DRAWER=4 (or any number greater than 3). The printer cannot find drawer 4 so it picks from the default tray defined in step 1.

To use this tray with PCL jobs with either an ASCII LAN device description or a remote output queue, the WSCST (Workstation Customizing Object) must be edited. Refer to Chapter 6, "Advanced Host Print Transform Customization" in *AS/400 Printing IV*, GG24-4389 for details of modifying such an object. The source text you need to edit is:

```
:litdata.
:DWRNBR
  VAROFFSET=    3
  VARLEN=0
```

```
VARTYPE=CHRHEX
:elitdata.
DATA = '1B266C3548'X.
```

Change the last line to:

```
DATA = '1B266C3248'X.
```

10.3.4.2 Output bins

Table 20 applies to Network Printer 17 only. These options are available only on this model.

Mailbox bins and Offset Stacker/Jogger

To send output to these bins, specify the printer file OUTBIN parameter according to Table 20. The Offset Stacker/Jogger and Mailbox are mutually exclusive. If an output bin is selected but not present, the output is sent to the bin indicated by the OUTPUT setting in PAPER MENU.

Table 20. Output bin selection

OUTBIN parameter in printer file	Tray name on printer
1	Main output bin
2	Offset stacker/jogger
3	Mailbox Bin 1
4	Mailbox Bin 2
5	Mailbox Bin 3
6	Mailbox Bin 4
7	Mailbox Bin 5
8	Mailbox Bin 6
9	Mailbox Bin 7
10	Mailbox Bin 8
11	Mailbox Bin 9
12	Mailbox Bin 10

Table 21 applies to the NP24 only. The finisher option is available only on this model.

2000-sheet finisher

To send output to these bins, specify the printer file OUTBIN parameter according to Table 21.

Continuous stacking (or tray linking of the three output bins in the finisher) may be selected through the printer operator panel, as well as in the OUTBIN parameter of the printer file. Do not mix jobs that use continuous stacking and individual output bin selection. The printer will honor the latter. Therefore, jobs might be mixed in the three finisher trays. If you want to use the continuous stacking feature, set this at the printer and leave the printer file OUTBIN parameter at its default value of *DEV D (device default).

If an output bin is selected but not present, the output is sent to the bin indicated by the OUTPUT setting in PAPER MENU.

Table 21. Output bin selection

OUTBIN parameter in printer file	Tray name on printer and output orientation
1	Main output bin, face down
2	Side output tray, face up
3	Top tray of Finisher, face down
4	Middle tray of Finisher, face down
5	Bottom tray of Finisher, face down
6	Top tray of Finisher, face up
7	Middle tray of Finisher, face up
8	Bottom tray of Finisher, face up
9	Continuous stacking, face down

10.4 Attachment information

The diagram in Figure 158 on page 206 summarizes the connectivity options for the network printer range. The two main methods of attaching a network printer to the AS/400 system are:

- As PCL printers using:
 - A remote output queue (V3R1/V3R6 and later)
 - A direct TCP/IP LAN device description (V3R7 and later)
 - Through a PC, 5250 terminal, or LAN attachment device using host print transform (HPT)
- As IPDS or SCS printers using:
 - Twinax
 - LAN (using Token-Ring or an Ethernet interface card)

For details of these methods, refer to one or more of the following sources:

- Chapter 11, “Configuring LAN-attached printers” on page 223, in this publication
- Chapter 3, “Attaching to the AS/400 (Twinax)” in *Twinax/Coax Configuration Guide*, G544-5241
- Chapter 10, “AS/400 to print PCL and PostScript files” and Chapter 11, “AS/400 to print IPDS files” in *Ethernet and Token-Ring Guide*, G544-5240

10.4.1 Network Printer Manager

This software should be regarded as essential for managing and maintaining a network of network printers. Running on a PC client such as OS/2, Windows 95, or Windows NT, it permits remote configuration and management of the network printer range. For full details, refer to the Web site at:

<http://www.printers.ibm.com/npm.html>

It may be downloaded free of charge. It is also supplied on the CD-ROM that accompanies the printers.

For a system or network administrator, the utility may be used for:

- Configuring the printer after basic set-up by the end-user.
- Information regarding the printers' configuration such as paper-handling capabilities, installed features, and usage data.
- Management of the printer in day-to-day operations, including:
 - Notifying you of problems as soon as they appear and before they are reported by the user.
 - Where the problem lies (for example, a cover open or a paper jam).
 - Advance notice of certain conditions (for example, low toner level).
 - Remote reset of the printer, if necessary.
- Upgrading Token-Ring or Ethernet software remotely “on the fly” (that is, without ending the writer to the printer).

The version of Network Printer Manager for the Web may also be used to manage printers that provide standard printer compatibility within network environments (RFC 1759) such as the Hewlett-Packard 5Si and Lexmark Optra N.

10.5 Output presentation

This section explains why the presentation of your printed output may vary depending on how the network printer is configured.

10.5.1 IPDS, AFP=*YES

This refers to the DEVTYPE and AFP parameters in the printer device description. For this mode, it is important to remember that the *physical page* size is determined by the printer reporting its loaded paper size back to PSF/400. The *logical page* size is dictated by the PAGESIZE parameter in the printer file.

10.5.2 IPDS, AFP=*NO

This refers to the DEVTYPE and AFP parameters in the printer device description. For this mode, it is important to remember that both the physical and logical page sizes are determined by the page size defined in the spooled file attributes. Therefore, the physical page and the logical page sizes are the same as far as OS/400 is concerned.

10.5.3 SCS mode

SCS mode is the operating mode when the device description is an emulated 3812 Model 1. The page size depends on the settings on the printer, together with any changes made by data stream commands such as lines per inch or characters per inch. Such commands override settings made at the printer.

10.5.4 Using the QPRTVALS data area

A system-wide data area may be set up for your printer writers, if so desired. This supports a number of functions for all *IPDS, AFP=YES printers, not just the network printers.

To create the data area, issue the following commands:

```
CRTDTAARA DTAARA(QUSRSYS/QPRTVALS) TYPE(*CHAR) LEN(256)
```

```
CHGOBJOWN OBJ(QUSRSYS/QPRTVALS) OBJTYPE(*DTAARA)  
NEWOWN(QSYS) CUROWNAUT(*SAME)
```

```
GRTOBJAUT OBJ(QUSRSYS/QPRTVALS) OBJTYPE(*DTAARA)  
USER(*PUBLIC) AUT(*ALL)
```

The first command creates the data area (note that you must create it in library QUSRSYS). The second command assigns ownership of the object to QSYS, and the third command makes it available to all users. The functions provided by QPRTVALS are not available if the latter steps are not performed.

You can check the setting of QPRTVALS at any time by typing:

```
DSPDTAARA DTAARA(QUSRSYS/QPRTVALS)
```

The functions are enabled by the character “Y” being present in one of the first six positions of the data area. The available functions are:

QPRTVALS

<u>Data area</u>	<u>Function</u>
Position 1	Logical page origin is the same as physical page origin.
Position 2	Change rotation of the logical page (on older printers).
Position 3	Emulate a 3835-1 unprintable border on a 3835-2 printer.
Position 4	Do not move overlays with front and back margins.
Position 5	Increase the *COR top margin.
Position 6	Use scalable fonts for MULTIUP and COR.

Most of the settings for QPRTVALS are covered in Chapter 5, “AS/400 Printing Enhancements” in *AS/400 Printing IV*, GG24-4389.

10.5.4.1 Logical and physical page origin

With a printer configured as *IPDS, AFP=*YES, the physical page size is returned to PSF/400 by the printer, including dimensions of any unprintable borders. PSF/400 offsets the logical page onto the physical page, taking into account the unprintable border. This function of QPRTVALS puts the logical page back on top of the physical page origin again.

If you are designing new applications and you can place all of your data in the printable area, we advise that you map the logical page origin to the physical page origin using this function of QPRTVALS so that output from your new applications is aligned correctly, whether you print to printers with or without an unprintable area. This is also the output presentation seen on a printer configured as *IPDS, AFP=*NO.

To activate this function, ensure the printer writer is ended and type:

```
CHGDTAARA DTAARA(QUSRSYS/QPRTVALS (1 1)) VALUE('Y')
```

This places the character “Y” in the first byte of the data area. Then restart the print writer.

10.5.4.2 Increased COR top margin

This is one of the few changes you can make to the COR facility. COR is used when the Page Rotation parameter in the printer file is set to *COR, and is frequently invoked when the rotation is *AUTO. System-supplied printer files default to *AUTO. *COR presents your output on a logical page size of 11 inches wide by 8.5 inches deep (that is, in landscape orientation). It also increases the character-per-inch value (for example, from 10 or 12 cpi to 13.3 or 15 cpi).

When printing on punched paper, the top margin of 0.5 inches may not be enough for the text to clear the holes. You can increase the margin to 0.75 inches by using this part of QPRTVALS. Note that the lines-per-inch (LPI) value is also slightly increased, compressing the lines of output slightly.

Position 5 for QPRTVALS also works if the logical page has been rotated 180 degrees using the PSFCFG parameter EDGEORIENT.

To activate this function, ensure the printer writer is ended and type:

```
CHGDTAARA DTAARA(QUSRSYS/QPRTVALS (5 1)) VALUE('Y')
```

This places the character “Y” in the fifth byte of the data area.

10.5.5 Using the IPDS menu PAGE setting

This menu item determines how data is positioned on the page at the printer level.

10.5.5.1 PAGE=WHOLE

This is the default (that is, use the whole page for printing). Any changes to the positioning of data are made at the host. Changes to the X or Y-OFFSET values, as described later, are an exception, these are changes made at the printer microcode level. The host is unaware of these differences.

For Network Printer 24, data may fall into the unprintable area if position 1 in QPRTVALS is set to “Y”. If the printer file FIDELITY keyword is set to *ABSOLUTE and the IPDS MENU VPA CHK item is ON, an IPDS negative acknowledgement (NACK) with sense data X'08C1..00' is generated and the job is held.

Figure 163 illustrates the effect of this parameter on the Network Printer 24.

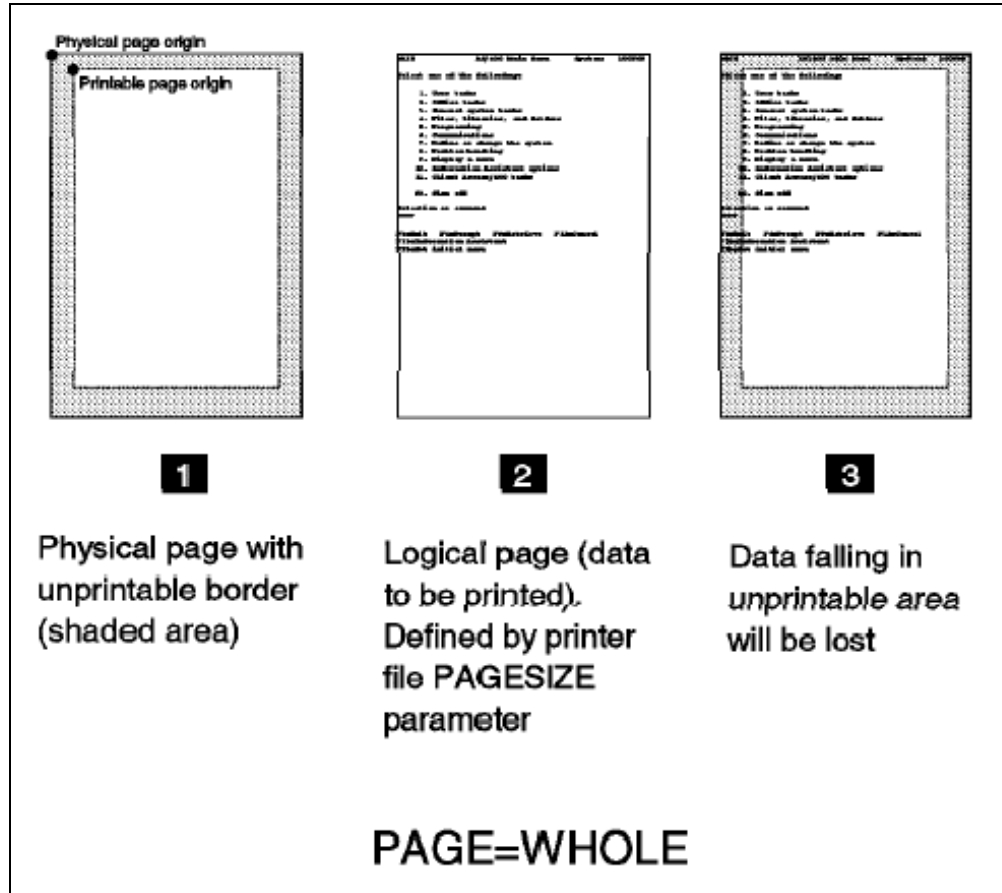

Figure 163. Output presentation with `PAGE=WHOLE` on Network Printer 24

We strongly recommend that you use the `PAGE=WHOLE` setting for IPDS printing. However, for applications with particular requirements, you can use other page settings, as discussed here.

10.5.5.2 `PAGE=PRINT`

This setting re-positions the logical page origin, attempting to print at least some of the data even if some is lost. The logical page origin is moved to avoid the unprintable border (regardless of whether any data falls in the unprintable area). This is usually done to preserve the data in the top left-hand corner of the page so data to the right of the page or in the lower-right area may be lost (fall in the unprintable border or even off the physical page). Whether an exception is reported depends on the setting of the `VPA CHK` item (Valid Printable Area Check). If you use the `PAGE=PRINT` setting, set `VPA CHK=OFF`.

Figure 164 on page 220 illustrates the effect of this parameter on Network Printer 24.

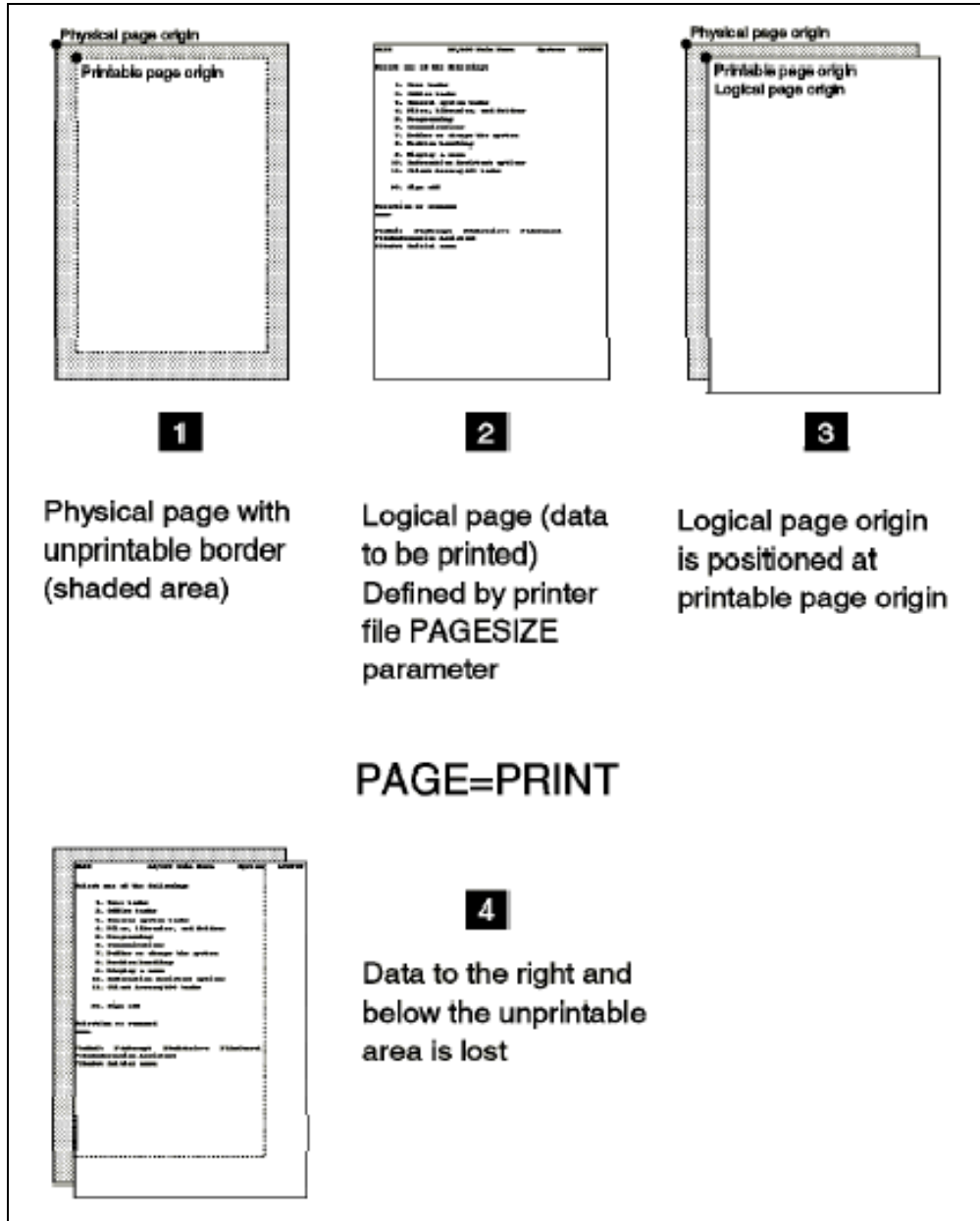

Figure 164. Output presentation with `PAGE=PRINT`

We recommend that you use this setting only if you are printing non-critical data.

10.5.5.3 `PAGE=COMP1`

This setting is similar to `PAGE=PRINT` except that the lines per inch for any lines of IPDS text are compressed in an attempt to fit the data on the page and keep it out of the unprintable border. This setting is not recommended for new applications.

10.5.5.4 `PAGE=COMP2`

This setting works the same way as `PAGE=COMP1`, but with more IPDS positioning commands. Neither of these settings move images, graphics, or barcodes. This setting is not recommended for new applications.

10.5.6 Edge-to-edge printing

We recommend that you set the IPDS Menu item EDGE-EDGE to ON for AFP printing on Network Printer 12 and Network Printer 17 models. Only these models have edge-to-edge printing ability.

10.5.6.1 Network Printer 12/17 and 24 printable area compatibility

The network printers have unprintable borders of 4mm at the edges of the paper (for A4, the unprintable borders on the long edges are 3.86mm). The Network Printer 12 and Network Printer 17 can print to the edge of the paper if the EDGE-to-EDGE item is switched on (in the TWINAX SETUP menu for SCS printing and in the IPDS MENU for IPDS printing).

Network Printer 24 cannot print to the edge of the paper. It maintains its unprintable borders as previously explained. Therefore, in a network of mixed Network Printer 12/17 and Network Printer 24 printers, print output might be positioned differently. Normally this is not an issue. If the application uses very precise formatting, or exact alignment with preprinted or electronic forms, steps must be taken to ensure compatible output. This may be achieved either by adjusting host settings, or by adjusting the individual printer settings as follows:

- Host adjustment:

Rather than manage the setup of multiple individual printers, we prefer that you control adjustments to the logical page at the host. To do this, follow these steps:

1. Set Network Printer 12/17 printers to use edge-to-edge printing.
2. Leave X and Y-offsets (in IPDS MENU) at 0 on all models.
3. Use position 1 of QPRTVALS to align the logical page origin with the physical page origin.
4. Design applications to avoid the unprintable areas of the Network Printer 24.

Using this as a basis ensures consistency of output across present and future AFP printers.

- Printer adjustments:

If the EDGE-EDGE item in the IPDS MENU is set to OFF, the Network Printer 12 and Network Printer 17 unprintable borders are the same as those of the NP24 with the exception that an A4 page has slightly different unprintable borders on the long edge. This is shown in Figure 165 on page 222.

The difference between these borders is small ($4 - 3.86 \text{ mm} = 0.14\text{mm}$). However, if the data in your print application is precise (for example, you need to place a field of text inside a pre-printed box), you might see alignment differences between the Network Printer 12/17 and the Network Printer 24 when you are not using edge-to-edge printing.

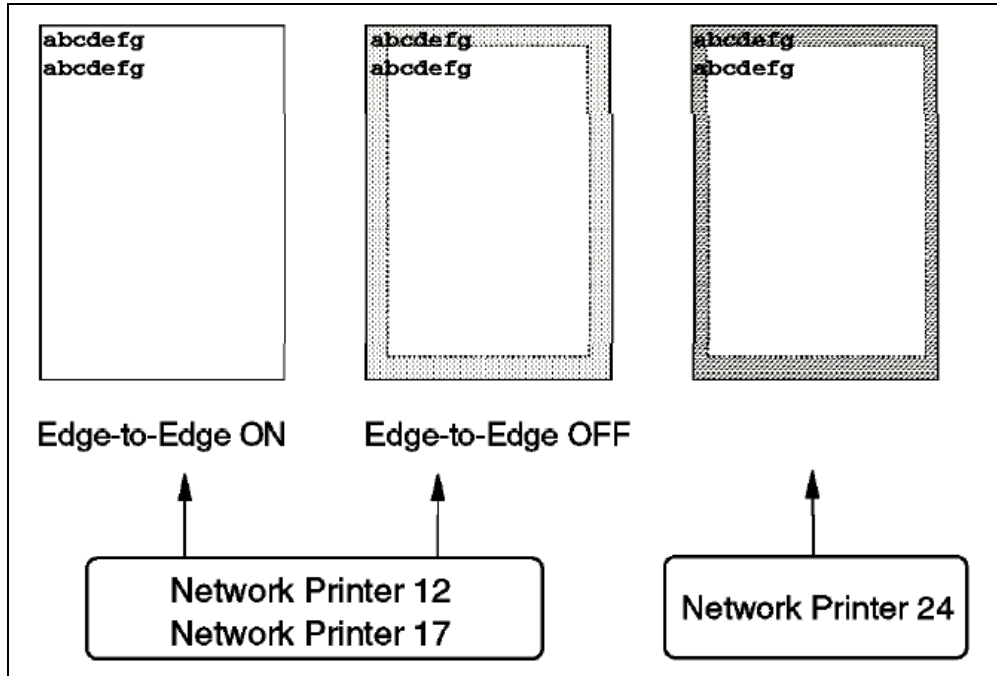

Figure 165. Relative printable areas of Network Printer 12/17 and Network Printer 24 printers

If it is necessary to make an adjustment on the printer, the IPDS MENU has options to adjust the offset of the printed page (that is, adjust the origin at which the *logical page* is placed on the *physical page*). For the Network Printer 24 printer, you can move the left-hand unprintable border by 0.14mm to match that of the Network Printer 12/17. However, the permissible values for the X-OFFSET and Y-OFFSET are measured in pels. Because this is a 600-pel printer, (that is, 600 pels per inch), you can calculate the following measurements:

- 600 pels = 1 inch
- 25.4mm = 1 inch, therefore:
- 1 mm = 600 / 25.4 pels
- 1 mm = 23.6 pels
- 0.14 mm is approximately 2 to 3 pels

Therefore, you can set the Network Printer 24s X-OFFSET to 2 or 3 in the IPDS MENU.

Note: This affects only IPDS printing, and not PCL or PostScript printing. This should be sufficiently similar to the settings of the Network Printer 12 and Network Printer 17 with edge-to-edge off.

We recommend that you do not adjust individual printer settings unless absolutely necessary. Host adjustments, together with edge-to-edge printing, ensures that your output presentation is consistent across your network printer inventory.

Chapter 11. Configuring LAN-attached printers

Several printer attachment methods are available on the AS/400 system. This appendix provides information on how to configure AS/400 LAN-attached IPDS or ASCII printers. This chapter is divided in two parts:

- Configuring LAN-attached IPDS printers
- Configuring LAN-attached ASCII printers

For considerations on LAN-attached IPDS printers, see 1.4.2, “IPDS printers LAN-attached” on page 16. For considerations on LAN-attached ASCII printers, see 1.4.5, “ASCII printers LAN-attached” on page 19. For a discussion on IPDS printers versus ASCII printers, see 1.6.4, “USERASCII spooled files” on page 25.

Note: For additional configuration information, see *Ethernet and Token-Ring Configuration Guide*, G544-5240.

11.1 Configuring LAN-attached IPDS printers

The following IBM AS/400 IPDS printers can be LAN-attached to the AS/400 system:

- Any IPDS printer with an IBM Advanced Function Common Control Unit (AFCCU), including:
 - IBM 3130
 - IBM 3160
 - Infoprint 60
 - Infoprint 62
 - Infoprint 2000
 - Infoprint 3000
 - Infoprint 4000
- IBM AS/400 network printers with the appropriate LAN card, including:
 - IBM Network Printer 12
 - IBM Network Printer 17
 - Infoprint 20
 - Infoprint 21
 - Infoprint 32
 - Infoprint 40
 - Infoprint 70

Note: For more information on network printers, see Chapter 10, “IBM AS/400 network printers” on page 205.

- The IPDS printers IBM 3812, 3816, 3912, 3916, 3112, 3116, 4028, 4230, and 6400 using the I-DATA 7913 Printer LAN Attachment box (TCP/IP Token-Ring or Ethernet)

Note: See 11.1.3, “TCP/IP BOOT service for V4R1 and later” on page 237, for information on how to change the I-DATA 7913 setting.

The configuration of LAN-attached IPDS printers differ depending on the version and release of the OS/400. This section includes an example for Version 3.0 Release 2.0 and Version 3.0 Release 7.0 and later.

Note: For previous releases (V3R1 or V3R6), see 12.1.7, “Configuring LAN-attached IPDS printers” on page 257, for instructions.

If your TCP/IP network is not already set up on your AS/400 system, see 12.1.1, “Setting up a TCP/IP network on the AS/400 system” on page 253. The configuration steps are:

1. Check that Print Services Facility/400 (PSF/400) is installed on your system (see 1.3.2.3, “Is PSF/400 installed” on page 11).
2. To avoid any problem, check to have the latest cumulative PTFs installed on your system (see 12.10, “Additional information” on page 278).
3. Complete your printer setup. If your printer is an IBM Network Printer, see 10.3, “Printer setup” on page 209, for detailed information.
4. Create a printer device description.
5. Create a PSF configuration object.
6. Ping the TCP/IP address, vary on the printer, and start the printer writer. For detailed information, see 12.1.3, “Pinging the TCP/IP address” on page 254.

11.1.1 Configuring LAN-attached IPDS printers on V3R2

If you migrate from V3R1 to V3R2, the WRKAFP2 data area is replaced by a PSF configuration object created using the Create PSF Configuration (CRTPSFCFG) command.

During the first Start Print Writer (STRPRTWTR) after the migration to V3R2, the system automatically creates a PSF configuration object using the values specified in the data area (WRKAFP2). The name of the PSF configuration object is the same as the printer device description name, and the PSF configuration object is placed into the library QGPL.

11.1.1.1 Creating the device description

To create the device description for your printer, follow these steps:

1. Type the Create Device description Printer (CRTDEVPR) command on any command line, and press the F4 (Prompt) function key. A display appears as shown in Figure 166.

```
                                Create Device Desc (Printer) (CRTDEVPR)
Type choices, press Enter.

Device description . . . . . PRT01      Name
Device class . . . . . *RMT           *LCL, *RMT, *VRT, *SNPT, *LAN
Device type . . . . . *IPDS          3287, 3812, 4019, 4201...
Device model . . . . . 0              0, 1, 2, 3, 4, 10, 13, 301...

                                                                Bottom
F3=Exit  F4=Prompt  F5=Refresh  F10=Additional parameters  F12=Cancel
F13=How to use this display  F24=More keys
```

Figure 166. Create Device Description (Printer) V3R2 (Part 1 of 6)

2. On this display, enter the following parameter values:

- **Device description:** The name of your printer (in this example, PRT01)
- **Device class:** *RMT
- **Device type:** *IPDS
- **Device model:** 0

Press the Enter key to continue. The display shown in Figure 167 appears.

```
                                Create Device Desc (Printer) (CRTDEVPRT)

Type choices, press Enter.

Device description . . . . . > PRT01      Name
Device class . . . . . > *RMT             *LCL, *RMT, *VRT, *SNPT, *LAN
Device type . . . . . > *IPDS            3287, 3812, 4019, 4201...
Device model . . . . . > 0                0, 1, 2, 3, 4, 10, 13, 301...
Advanced function printing . . . *YES      *NO, *YES

                                                                Bottom
F3=Exit  F4=Prompt  F5=Refresh  F10=Additional parameters  F12=Cancel
F13=How to use this display      F24=More keys
```

Figure 167. Create Device Description (Printer) V3R2 (Part 2 of 6)

3. On this display, set the Advanced function printing parameter value to *YES.

Note: Any IPDS LAN-attached printer must be configured AFP=*YES.

Then, press the Enter key to continue. A display appears as shown in Figure 168.

```
                                Create Device Desc (Printer) (CRTDEVPRT)

Type choices, press Enter.

Device description . . . . . > PRT01      Name
Device class . . . . . > *RMT             *LCL, *RMT, *VRT, *SNPT, *LAN
Device type . . . . . > *IPDS            3287, 3812, 4019, 4201...
Device model . . . . . > 0                0, 1, 2, 3, 4, 10, 13, 301...
Advanced function printing . . . *YES      *NO, *YES
AFP attachment . . . . . *APPC           *WSC, *APPC

                                                                Bottom
F3=Exit  F4=Prompt  F5=Refresh  F10=Additional parameters  F12=Cancel
F13=How to use this display      F24=More keys
```

Figure 168. Create Device Description (Printer) V3R2 (Part 3 of 6)

4. On this display, set the AFP attachment parameter value to *APPC.

Press the Enter key to continue. A display appears like the example shown in Figure 169 on page 226.

```

                                Create Device Desc (Printer) (CRTDEVPRT)

Type choices, press Enter.

Device description . . . . . > PRT01      Name
Device class . . . . . > *RMT           *LCL, *RMT, *VRT, *SNPT, *LAN
Device type . . . . . > *IPDS          3287, 3812, 4019, 4201...
Device model . . . . . > 0             0, 1, 2, 3, 4, 10, 13, 301...
Advanced function printing . . . *YES    *NO, *YES
AFP attachment . . . . . *APPC         *WSC, *APPC
Online at IPL . . . . . *YES          0-65535
Font:
  Identifier . . . . . > 11            3, 5, 11, 12, 13, 18, 19...
  Point size . . . . . *NONE          000.1-999.9, *NONE
Form feed . . . . . *AUTOCUT         *TYPE, *CONT, *CUT, *AUTOCUT
Separator drawer . . . . . *FILE      1-255, *FILE
Separator program . . . . . *NONE     Name, *NONE
Library . . . . .                   Name, *LIBL, *CURLIB

                                                                Bottom.
F3=Exit  F4=Prompt  F5=Refresh  F10=Additional parameters  F12=Cancel
F13=How to use this display  F24=More keys

```

Figure 169. Create Device Description (Printer) V3R2 (Part 4 of 6)

5. On this display, enter the following parameter values:

- **Online at IPL:** *YES
- **Font identifier:** 11 (or another font ID used as the default font)
- **Form feed:** Specifies the form feed attachment used for this printer. Enter *AUTOCUT for a page printer, or *CONT for a continuous forms printer (in this example, *AUTOCUT).

Leave the default values for the other parameters, and press the Enter key to continue. The display shown in Figure 170 appears.

```

                                Create Device Desc (Printer) (CRTDEVPRT)

Type choices, press Enter.

Device description . . . . . > PRT01      Name
Device class . . . . . > *RMT           *LCL, *RMT, *VRT, *SNPT, *LAN
Device type . . . . . > *IPDS          3287, 3812, 4019, 4201...
Device model . . . . . > 0             0, 1, 2, 3, 4, 10, 13, 301...
Advanced function printing . . . *YES    *NO, *YES
AFP attachment . . . . . *APPC         *WSC, *APPC
Online at IPL . . . . . *YES          *YES, *NO
Font:
  Identifier . . . . . > 11            3, 5, 11, 12, 13, 18, 19...
  Point size . . . . . *NONE          000.1-999.9, *NONE
Form feed . . . . . *AUTOCUT         *TYPE, *CONT, *CUT, *AUTOCUT
Separator drawer . . . . . *FILE      1-255, *FILE
Separator program . . . . . *NONE     Name, *NONE
Library . . . . .                   Name, *LIBL, *CURLIB
Printer error message . . . . . *INQ   *INQ, *INFO

                                                                More...
F3=Exit  F4=Prompt  F5=Refresh  F10=Additional parameters  F12=Cancel
F13=How to use this display  F24=More keys

```

Figure 170. Create Device Description (Printer) V3R2 (Part 5 of 6)

You can leave the default value *INQ for the Printer error message parameter. To continue, press the Page Down key. The display shown in Figure 171 appears.

```

                                Create Device Desc (Printer) (CRTDEVPR1)

Message queue . . . . . QSYSOPR      Name, QSYSOPR
  Library . . . . . *LIBL          Name, *LIBL, *CURLIB
Maximum pending request . . . . . 6      1-31
Print while converting . . . . . *YES    *NO, *YES
Print request timer . . . . . *NOMAX   1-3600, *NOMAX
Form definition . . . . . F1C10110     Name
  Library . . . . . *LIBL          Name, *LIBL, *CURLIB
Character identifier:
  Graphic character set . . . . . *SYSVAL  1-32767, *SYSVAL
  Code page . . . . .                1-32767
Remote location . . . . . TCPIP        Name
Local location . . . . . *NETADR      Name, *NETADR
Remote network identifier . . . . . *NETADR  Name, *NETADR, *NONE
Mode . . . . . QSPWTR              Name, SPWTR, *NETADR
Text description . . . . . Device description for PRT01

Dependent location name . . . . . *NONE    Name, *NONE

F3=Exit  F4=Prompt  F5=Refresh  F10=Additional parameters  F12=Cancel
F13=How to use this display  F24=More keys
                                Bottom

```

Figure 171. Create Device Description (Printer) V3R2 (Part 6 of 6)

6. Enter any name for the Remote location parameter (in this example, TCPIP) and a text description for device configuration object. You can leave the default parameter values for the other parameters.

Then, press the Enter key to create the device description. You receive the message Description for device PRT01 created.

11.1.1.2 Creating the PSF configuration object for V3R2

To create the PSF configuration support, follow these steps:

1. Type the Create PSF Configuration (CRTPSFCFG) command on any command line, and press F4 (Prompt). The display shown in Figure 172 on page 228 appears.

```

Create PSF Configuration (CRTPSF CFG)

Type choices, press Enter.

PSF configuration . . . . . > PRT01      Name
Library . . . . . > QGPL      Name, *CURLIB
User resource library list . . . *JOBLIBL *JOBLIBL, *CURLIB, *PRTF...
Device resource library list . . *DFT      Name, *DFT
      + for more values
IPDS pass through . . . . . *Yes      *NO, *YES
Activate release timer . . . . . *NORDYF *NORDYF, *IMMED...
Release timer . . . . . *SEC15      1-1440, *NOMAX, *SEC15...
Restart timer . . . . . *IMMED      1-1440, *IMMED
SNA retry count . . . . . 2      1-99, *NOMAX
Delay time between SNA retries 10      0-999
Text 'description' . . . . . PSF configuration object for PRT01

More...

F3=Exit  F4=Prompt  F5=Refresh  F12=Cancel  F13=How to use this display
F24=More keys

```

Figure 172. Create PSF Configuration object V3R2 (Part 1 of 3)

2. On this display, enter the following parameter values:

- **PSF configuration:** Enter the name of the PSF configuration object. Must be the *same name* as the name of the printer device description (in this example, "PRT01").
- **Library:** QGPL (the default or any library name).
- **User resource library list:** Specifies the user resource library list to be used for searching AFP resources.
- **Device resource library list:** Specifies the device resource library list to be used for searching AFP resources (in this example, *JOBLIBL).
- **IPDS pass through:** IPDS pass through reduces the PSF/400 conversion time for some *SCS and *IPDS spooled files. Enter *YES or *NO (in this example, *YES).
- **Activate release timer:** Specifies the point at which the release timer (RLSTMR) is activated. Leave the default value "*NORDYF".
- **Release timer:** This is the timer whose value is referenced by the Activate release timer (ACTRLSTMR) parameter.
 If the ACTRLSTMR parameter is set to *NORDYF, the release timer parameter specifies the amount of time to wait after the last page of the last ready spooled file has printed before releasing the printer (in this example, *SEC15).
- **Note:** If only one system is using the printer, specify *NOMAX. There is no need to release the printer for another system.
- **Restart timer:** Specifies the amount of time to wait before the printer writer attempts to re-establish either a session or dialog.
- **SNA retry count:** Specifies the number of retry attempts to establish a session. This is the number of retries that PSF/400 makes to establish a connection with a printer.

Note: Even if the parameter name is “SNA retry count”, this is also valid for TCP/IP when the PTF SF42745 (V3R2) is installed on the system.

- **Delay time between retries:** 10
- **Text 'description':** A description for your PSF configuration object

To continue, press F10 (additional parameters) and then the Page Down key. The display shown in Figure 173 appears.

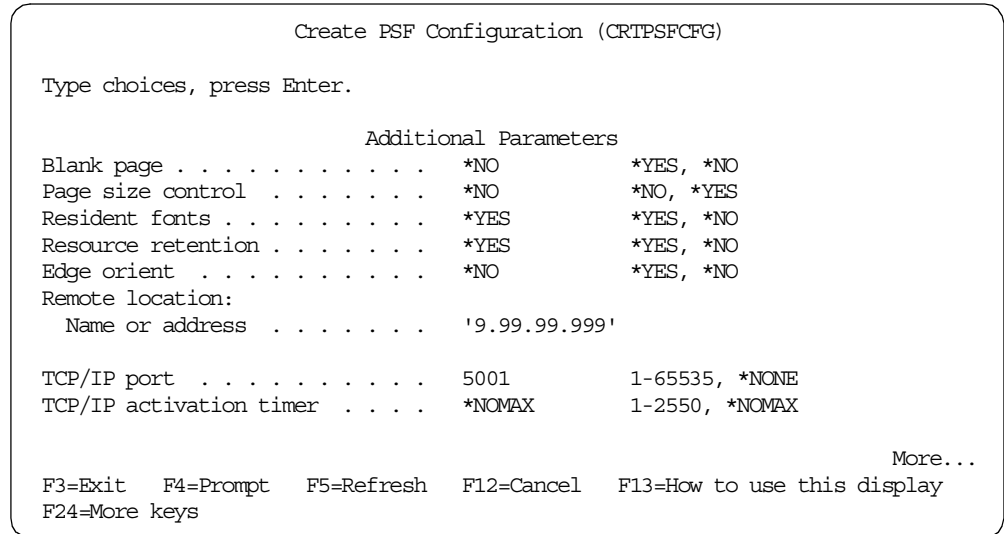

Figure 173. Create PSF Configuration object V3R2 (Part 2 of 3)

3. Enter the following parameter values:

- **Blank page:** Specifies whether PSF/400 issues a blank page after every separator page and spooled file copy that contains an odd number of pages. This parameter is for a continuous forms printer.
- **Page size control:** Specifies whether the page size (forms) in the printer is set by PSF/400. This parameter only applies to: IBM 4230, 4247, 4028, 6404, 6408, 6412, and IBM network printers.
Note: If you change the drawers for using different paper sizes, enter *YES for this parameter.
- **Resident fonts:** Specifies if the printer resident fonts are used by PSF/400.
- **Resource retention:** Specifies whether resource retention across spooled files is enabled.
- **Edge orient:** When the page rotation value of a spooled file is *COR or *AUTO and the system rotates the output, a 90-degree rotation is normally used. When this parameter is *YES, PSF/400 rotates the output 270 degrees instead of 90 degrees.
- **Remote location name:** The IP address of your printer (in this example, 9.99.99.999).
- **TCP/IP port:** 5001
- **TCP/IP activation timer:** *NOMAX

Note: If only one AS/400 system uses the printer, use the default value (170 seconds). If more than one system shares the printer, set the value to *NOMAX, which causes PSF/400 to wait to establish a connection.

To continue, press the Page Down key. The display shown in Figure 174 appears.

```

                                Create PSF Configuration (CRTPSF CFG)

Type choices, press Enter.
PSF defined option . . . . . *NONE          *NONE
      + for more values
Replace . . . . . *YES          *YES, *NO
Authority . . . . . *LIBCRTAUT      Name, *LIBCRTAUT, *CHANGE...

                                                                    Bottom
F3=Exit  F4=Prompt  F5=Refresh  F12=Cancel  F13=How to use this display
F24=More keys

```

Figure 174. Create PSF Configuration object V3R2 (Part 3 of 3)

4. Leave the default parameters values, and press the Enter key to create the PSF configuration object.

11.1.2 Configuring LAN-attached IPDS printers on V3R7 and later

If you migrate from V3R1, V3R2, or V3R6 to V3R7 or later, always delete all the printer device descriptions and the associated WRKAFP2-created data areas (V3R1 and V3R6). You can check that all objects are deleted by using the Work with Objects (WRKOBJ) command and specifying the name of the printer as the object name.

11.1.2.1 Creating a device description

To create the device description for your printer, complete these steps:

1. Type the Create Device description Printer (CRIDEVPRT) command on any command line and press F4 (Prompt). The display shown in Figure 175 appears.

```

Create Device Desc (Printer) (CRTDEVPRT)

Type choices, press Enter.

Device description . . . . . PRT01      Name
Device class . . . . . *LAN           *LCL, *RMT, *VRT, *SNPT, *LAN
Device type . . . . . *IPDS          3287, 3812, 4019, 4201...
Device model . . . . . 0              0, 1, 2, 3, 4, 10, 13, 301...

Bottom
F3=Exit  F4=Prompt  F5=Refresh  F10=Additional parameters  F12=Cancel
F13=How to use this display  F24=More keys

```

Figure 175. Create Device Description-V3R7 and later (Part 1 of 6)

2. On this display, enter the following parameter values:

- **Device description:** The name of your printer (in this example, "PRT01")
- **Device class:** *LAN
- **Device type:** *IPDS
- **Device model:** 0

Then, press the Enter key to continue. The display shown in Figure 176 appears.

```

Create Device Desc (Printer) (CRTDEVPRT)

Type choices, press Enter.

Device description . . . . . > PRT01      Name
Device class . . . . . > *LAN           *LCL, *RMT, *VRT, *SNPT, *LAN
Device type . . . . . > *IPDS          3287, 3812, 4019, 4201...
Device model . . . . . > 0              0, 1, 2, 3, 4, 10, 13, 301...
LAN attachment . . . . . *IP           *LEXLINK, *IP, *USRDFN

Bottom
F3=Exit  F4=Prompt  F5=Refresh  F10=Additional parameters  F12=Cancel
F13=How to use this display  F24=More keys

```

Figure 176. Create Device Description-V3R7 and later (Part 2 of 7)

On this display, set the LAN attachment parameter value to *IP.

To continue, press the Enter key. The display shown in Figure 177 on page 232 appears.

```

Create Device Desc (Printer) (CRTDEVPRT)

Type choices, press Enter.

Device description . . . . . > PRT01      Name
Device class . . . . . > *LAN           *LCL, *RMT, *VRT, *SNPT, *LAN
Device type . . . . . > *IPDS          3287, 3812, 4019, 4201...
Device model . . . . . > 0             0, 1, 2, 3, 4, 10, 13, 301...
LAN attachment . . . . . *IP           *LEXLINK, *IP, *USRDFN
Advanced function printing . . . *YES    *NO, *YES

Bottom

F3=Exit  F4=Prompt  F5=Refresh  F10=Additional parameters  F12=Cancel
F13=How to use this display  F24=More keys

```

Figure 177. Create Device Description-V3R7 and later (Part 3 of 7)

3. On this display, leave the default value *YES for the advanced function printing parameter.

To continue, press the Enter key. The display shown in Figure 178 appears.

```

Create Device Desc (Printer) (CRTDEVPRT)

Type choices, press Enter.

Device description . . . . . > PRT01      Name
Device class . . . . . > *LAN           *LCL, *RMT, *VRT, *SNPT, *LAN
Device type . . . . . > *IPDS          3287, 3812, 4019, 4201...
Device model . . . . . > 0             0, 1, 2, 3, 4, 10, 13, 301...
LAN attachment . . . . . *IP           *LEXLINK, *IP, *USRDFN
Advanced function printing . . . *YES    *NO, *YES
Port number . . . . . 5001            0-65535
Online at IPL . . . . . *YES          *YES, *NO
Font:
  Identifier . . . . . > 11           3, 5, 11, 12, 13, 18, 19...
  Point size . . . . . *NONE          000.1-999.9, *NONE
Form feed . . . . . *AUTOCUT         *TYPE, *CONT, *CUT, *AUTOCUT
Separator drawer . . . . . *FILE      1-255, *FILE
Separator program . . . . . *NONE     Name, *NONE
Library . . . . .                   Name, *LIBL, *CURLIB

Bottom

F3=Exit  F4=Prompt  F5=Refresh  F10=Additional parameters  F12=Cancel
F13=How to use this display  F24=More keys

```

Figure 178. Create Device Description-V3R7 and later (Part 4 of 7)

4. On this display, enter the following parameter values:

- **Port number:** 5001
- **Online at IPL:** *YES
- **Font identifier:** 11 (or another font ID used as the default font)
- **Form feed:** Specifies the form feed attachment used for this printer. Enter *AUTOCUT for page printer, or *CONT for a continuous forms printer (in this example, *AUTOCUT).

Leave the default values for the other parameters, and press the Enter key to continue. The display shown in Figure 179 appears.

```

                                Create Device Desc (Printer) (CRTDEVPRT)

Type choices, press Enter.

Device description . . . . . > PRT01      Name
Device class . . . . . > *LAN            *LCL, *RMT, *VRT, *SNPT, *LAN
Device type . . . . . > *IPDS           3287, 3812, 4019, 4201...
Device model . . . . . > 0              0, 1, 2, 3, 4, 10, 13, 301...
LAN attachment . . . . . *IP            *LEXLINK, *IP, *USRDFN
Advanced function printing . . . *YES    *NO, *YES
Port number . . . . . 5001             0-65535
Online at IPL . . . . . *YES           *YES, *NO
Font:
  Identifier . . . . . > 11            3, 5, 11, 12, 13, 18, 19...
  Point size . . . . . *NONE           000.1-999.9, *NONE
Form feed . . . . . *AUTOCUT          *TYPE, *CONT, *CUT, *AUTOCUT
Separator drawer . . . . . *FILE       1-255, *FILE
Separator program . . . . . *NONE      Name, *NONE
  Library . . . . . *NONE              Name, *LIBL, *CURLIB
Printer error message . . . . . *INQ   *INQ, *INFO
More...

F3=Exit  F4=Prompt  F5=Refresh  F10=Additional parameters  F12=Cancel
F13=How to use this display  F24=More keys

```

Figure 179. Create Device Description-V3R7 and later (Part 5 of 7)

You can leave the default value *INQ for the printer error message parameter. To continue, press the Page Down key. The display shown in Figure 180 appears.

```

                                Create Device Desc (Printer) (CRTDEVPRT)

Type choices, press Enter.

Message queue . . . . . QSYSOPR      Name, QSYSOPR
  Library . . . . . *LIBL            Name, *LIBL, *CURLIB
Activation timer . . . . . *NOMAX    1-2550, *NOMAX
Maximum pending request . . . . . 6    1-31
Print while converting . . . . . *YES  *NO, *YES
Print request timer . . . . . *NOMAX  1-3600, *NOMAX
Form definition . . . . . F1C10110   Name
  Library . . . . . *LIBL            Name, *LIBL, *CURLIB
Remote location:
  Name or address . . . . . '9.99.99.99'

User-defined options . . . . . *NONE   Name, *NONE
  + for more values

More...

F3=Exit  F4=Prompt  F5=Refresh  F10=Additional parameters  F12=Cancel
F13=How to use this display  F24=More keys

```

Figure 180. Create Device Description-V3R7 and later (Part 6 of 7)

5. On this display, enter the following parameter values:

- **Activation timer:** *NOMAX

Note: If only one AS/400 system uses the printer, use the default value (170 seconds). If more than one system shares the printer, set the value to *NOMAX, which causes PSF/400 to wait to establish a connection.

- **Remote location:** The IP address of your printer (in this example, 9.99.99.99).

You can leave the default values for the other parameters.

To continue, press the Page Down key. The display shown in Figure 181 appears.

```

                                Create Device Desc (Printer) (CRTDEVPRT)

Type choices, press Enter.

User-defined object:
  Object . . . . . NP17          Name, *NONE
  Library . . . . . QGPL         Name, *LIBL, *CURLIB
  Object type . . . . . *PSFCFG  *DTAARA, *DTAQ, *FILE...
  Data transform program . . . . . *NONE      Name, *NONE
  Library . . . . .              Name, *LIBL, *CURLIB
  User-defined driver program . . . *NONE     Name, *NONE
  Library . . . . .              Name, *LIBL, *CURLIB
  Text 'description' . . . . . Device description for PRT01

                                                                Bottom
F3=Exit  F4=Prompt  F5=Refresh  F10=Additional parameters  F12=Cancel
F13=How to use this display  F24=More keys

```

Figure 181. Create Device Description-V3R7 and later (Part 7 of 7)

On this display, enter the following parameter values:

- **User-defined object:** The name of the PSF configuration object (the one created in the next step with the CRTPSFCFG command, in this example, NP17)
- **Library:** Any library name (in this example, QGPL)
- **Object type:** *PSFCFG
- **Text 'description':** A text description for your printer configuration object

You can leave the default parameter values for the other parameters.

Then, press the Enter key to create the device description. You will receive the message Description for device PRT01 created.

11.1.2.2 Creating the PSF configuration object

To create the PSF configuration support, follow these steps:

1. Enter the Create PSF configuration (CRTPSFCFG) command on any command line, and press F4 (Prompt). The display shown in Figure 182 appears.

```

                                Create PSF Configuration (CRTPSFCFG)

Type choices, press Enter.

PSF configuration . . . . . > NP17          Name
  Library . . . . .          QGPL          Name, *CURLIB
User resource library list . . . *JOBLIBL  *JOBLIBL, *CURLIB, *PRTF...
Device resource library list . . *DFT          Name, *DFT
      + for more values
IPDS pass through . . . . . *YES          *NO, *YES
Activate release timer . . . . . *NORDYF     *NORDYF, *IMMED...
Release timer . . . . . > *SEC15         1-1440, *NOMAX, *SEC15...
Restart timer . . . . . *IMMED          1-1440, *IMMED
APPC and TCP/IP retry count . . 15          1-99, *NOMAX
Delay between APPC retries . . . 90          0-999
Automatic session recovery . . . *NO          *NO, *YES
Acknowledgment frequency . . . . 100         1-32767
Text 'description' . . . . . PSF configuration object

F3=Exit  F4=Prompt  F5=Refresh  F12=Cancel  F13=How to use this display
F24=More keys

```

Figure 182. Create PSF Configuration object-V3R7 and later (Part 1 of 3)

2. On this display, enter the following parameter values:

- **PSF configuration:** Any name, but must correspond to the name specified in the DEVD user-defined object parameter.

Note: The same PSF configuration object can be used for more than one printer.
- **Library:** Any library name, but must correspond to the name specified in the DEVD user-defined object library parameter.
- **User resource library list:** Specifies the user resource library list to be used for searching AFP resources.
- **Device resource library list:** Specifies the device resource library list to be used for searching AFP resources.
- **IPDS pass through:** IPDS pass through reduces the PSF/400 conversion time for some *SCS or *IPDS spooled files. Enter *YES or *NO (in this example, *YES).
- **Activate release timer:** Specifies the point at which the release timer (RLSTMR) is activated. Leave the default value NORDYF.
- **Release timer:** This is the timer whose value is referenced by the Activate Release Timer (ACTRLSTMR) parameter.

If the ACTRLSTMR parameter is set to *NORDYF, the release timer parameter specifies the amount of time to wait after the last page of the last ready spooled file has printed before releasing the printer (in this example, *SEC15).

Note: If only one system is using the printer, specify *NOMAX. There is no need to release the printer for another system.
- **Restart timer:** Specifies the amount of time to wait before the printer writer attempts to re-establish either a session or dialog.

- **APPC and TCP/IP retry count:** Named *SNA retry count* in V3R7 and V4R1. Specifies the number of retry attempts to establish a session. This is the number of retries that PSF/400 makes to establish a connection with a printer.
Note: Even if the name is “SNA retry count” in V3R7 and V4R1, this is also valid for TCP/IP when PTF SF42655 (V3R7) or SF43250 (V4R1) is installed on the system.
- **Delay time between retries:** 90 (the default value).
- **Automatic session recovery (V4R2):** Specifies whether PSF/400 automatically attempts to resume printing when a session has been unexpectedly ended by a device.
- **Acknowledgement frequency (V4R2):** Specifies the frequency, in pages, with which PSF/400 sends IPDS acknowledgment requests to a printer. The acknowledgment request responses from the printer contain information as to the status of pages sent to the printer.
- **Text 'description':** A description for your PSF configuration object.

To continue, press F10 (additional parameters) and then the Page Down key. The display shown in Figure 183 appears.

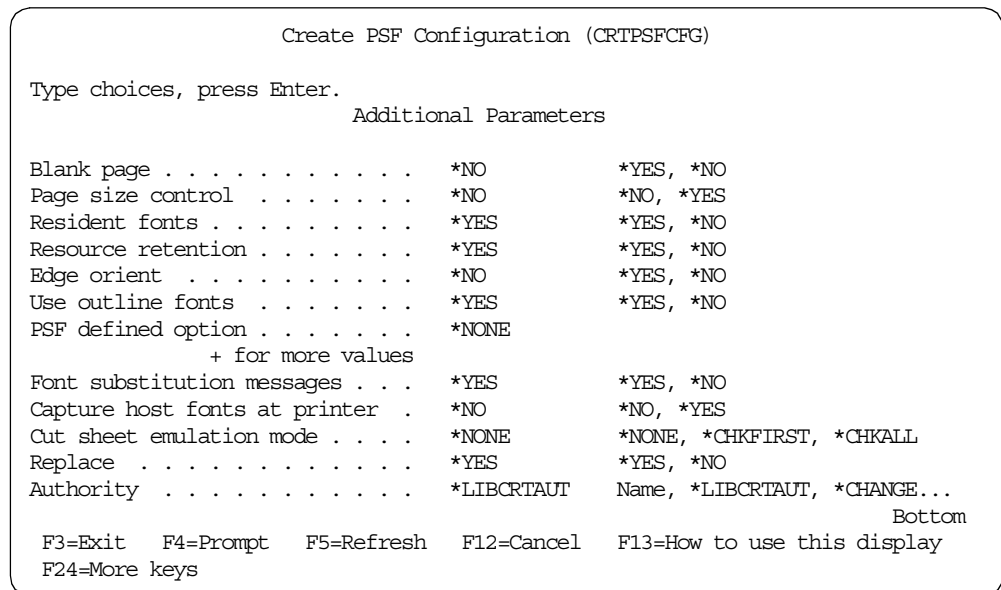

Figure 183. Create PSF Configuration object V3R7 and later (Part 2 of 3)

3. Enter the following parameter values:

- **Blank page:** Specifies whether PSF/400 issues a blank page after every separator page and spooled file copy that contains an odd number of pages. This parameter is for continuous forms printers.
- **Page size control:** Specifies whether the page size (forms) in the printer is set by PSF/400. This parameter only applies to the following printers: IBM 4230, 4247, 4028, 6404, 6408, 6412, and IBM network printers.

Note: If you change the drawers for using different paper sizes, enter *YES for this parameter.

- **Resident fonts:** Specifies if the printer resident fonts are used by PSF/400.
 - **Resource retention:** Specifies whether the resource retention across spooled files is enabled.
 - **Edge orient:** When the page rotation value of a spooled file is *COR or *AUTO and the system rotates the output, 90 degree rotation is normally used. When this parameter is *YES, PSF/400 rotates the output 270 degrees instead of 90 degrees.
 - **Use Outline fonts:** Specifies whether the user wants the requested downloadable AFP raster fonts replaced with the equivalent downloadable outline fonts.
- Note:** In V3R7 and V4R1, the Remote location name, TCP/IP port, and Activation timer parameters are displayed in the CRTPSFCFG command. They are ignored, since they are part of the printer device description.
- **Font substitution messages (V4R2):** Specifies whether PSF/400 logs the font substitution message.
 - **Capture host fonts (V4R2):** Specifies whether the printer should capture host downloaded fonts. See 4.10, “Font capturing” on page 108, for detailed information on font capturing.
 - **Cut sheet emulation (V4R2):** This parameter is for continuous forms printers. It specifies to what degree PSF/400 will do size checking of the document when using Cut Sheet Emulation.

To continue, press the Page Down key. The display shown in Figure 184 appears.

```

                                Create PSF Configuration (CRTPSFCFG)

Type choices, press Enter.
PSF defined option . . . . . *NONE          *NONE
      + for more values
Replace . . . . . *YES          *YES, *NO
Authority . . . . . *LIBCRTAUT    Name, *LIBCRTAUT, *CHANGE...

                                                                Bottom
F3=Exit   F4=Prompt   F5=Refresh   F12=Cancel   F13=How to use this display
F24=More keys

```

Figure 184. Create PSF Configuration object V3R7 and later (Part 3 of 3)

Leave the default parameter values, and press the Enter key to create the PSF configuration object.

11.1.3 TCP/IP BOOT service for V4R1 and later

Bootstrap Protocol (BOOTP) provides a dynamic method for associating workstations with servers and assigning IP addresses. The BOOTP Server is used to configure and provide support for the I-DATA-7913 Lan attachment. This attachment can be used to connect Twinax or Coax IPDS printers to the AS/400 system. Figure 185 on page 238 shows the Add BOOTP Table Entry display.

```

                                Add BOOTP Table Entry
                                System:  SYSTEM05
Network device:
Client host name . . . prt7913

MAC address . . . . . 098390907747A
IP address . . . . . 99.99.99.99
Hardware type . . . . . 6
Network routing:
Gateway IP address . . 99.99.99.99
Subnet mask . . . . . 99.999.99.99
Boot:
Type . . . . .
File name . . . . .

File path . . . . .

F3=Exit  F12=Cancel

```

Figure 185. Add BOOTP Table Entry display

The parameters are explained here:

- **Client Host name:** The name of the client host system.
- **Mac address:** The physical network address of the hardware that the client uses to access the network.
- **IP address:** The Internet Protocol (IP) address defined for the client.
- **Hardware type:** The type of network connection hardware the client is using to access the network. Valid values for hardware type are:
 - One Ethernet
 - Six Token-Ring or IEEE Ethernet (802.3)
- **Gateway IP address:** The gateway IP address of the network on which the client is loaded.
- **Subnet mask:** The subnet mask of the network on which the client is loaded.

11.2 Configuring LAN-attached ASCII printers

ASCII printers can be attached directly on the LAN (Token-Ring or Ethernet) using the following connection methods:

- PJL drivers *IBMPJLDRV or *HPPJLDRV (this support is available on OS/400 V3R7 and later releases)
- SNMP drivers

11.2.1 Configuring LAN-attached ASCII printers using LexLink

The following configuration example is for V3R7 and later. For prior releases (V3R1, V3R2, and V3R6), refer to Chapter 1 in *AS/400 Printing IV*, GG24-4389.

If you migrate from V3R1, V3R2, or V3R6 to V3R7 and later, we recommend that you delete the device descriptions for any ASCII printer LAN-attached using the LexLink protocol, and then re-create them (see Figure 186).

To create the device description for your printer, follow these steps:

1. Type the Create Device description Printer (`CRTDEVPRT`) command on the command line, and press F4 (Prompt).

```

                                Create Device Desc (Printer) (CRTDEVPRT)

Type choices, press Enter.

Device description . . . . . > MYPRT           Name
Device class . . . . . > *LAN                 *LCL, *RMT, *VRT, *SNPT, *LAN
Device type . . . . . > 3812                 3287, 3812, 4019, 4201...
Device model . . . . . > 1                   0, 1, 2, 3, 4, 10, 13, 301...
LAN attachment . . . . . *LEXLINK            *LEXLINK, *IP, *USRDFN
Switched line list . . . . .                Name
      + for more values
LAN remote adapter address . . . 10005A1095A2 000000000001-FFFFFFFFFFFFE
Adapter type . . . . . > *EXTERNAL           *INTERNAL, *EXTERNAL
Adapter connection type . . . . *PARALLEL  *PARALLEL, *SERIAL
Port number . . . . . 1                     0-65535
Online at IPL . . . . . *YES                 *YES, *NO
Font:
  Identifier . . . . . 11                    3, 5, 11, 12, 13, 18, 19...
  Point size . . . . . *NONE                 000.1-999.9, *NONE
Form feed . . . . . *AUTOCUT                *TYPE, *CONT, *CUT, *AUTOCUT
                                          More...

F3=Exit  F4=Prompt  F5=Refresh  F10=Additional parameters  F12=Cancelre
F13=How to use this display  F24=More keys

```

Figure 186. `CRTDEVPRT` for LAN-attached ASCII printer using LexLink (Part 1 of 3)

2. Enter the following parameter values:

- **Device description:** The name of your printer (in this example, MYPRT)
- **Device class:** *LAN
- **Device type:** 3812
- **Device model:** 1
- **LAN attachment:** *LEXLINK
- **LAN remote adapter address:** Specifies the 12-character hexadecimal LAN address of the ASCII printer.

Note: If an internal INA card is used, display the address using the printer's operator panel. For a MarkNet XLe, the address is printed on the back side of the device.
- **Adapter type:** Specify *INTERNAL if an internal INA card is used or *External if a MarkNet XLe is used.
- **Port number:** For the MarkNet XLe, use the following values:
 - 0 for serial port
 - 1 for parallel port
 - 2 for parallel port 2

Note: This parameter does not appear if the adapter type is *INTERNAL.
- **Online at IPL:** *YES
- **Font identifier:** 11 (or another font ID used as the default font)

- **Form feed:** Specifies the form feed attachment used for this printer. Enter *AUTOCUT for page printer or *CONT for a continuous forms printer (in this example, *AUTOCUT).

```

                                Create Device Desc (Printer) (CRTDEVPRT)

Type choices, press Enter.

Separator drawer . . . . . *FILE          1-255, *FILE
Separator program . . . . . *NONE          Name, *NONE
  Library . . . . .           Name, *LIBL, *CURLIB
Printer error message . . . . . *INQ       *INQ, *INFO
Message queue . . . . . QSYSOPR          Name, QSYSOPR
  Library . . . . .           *LIBL       Name, *LIBL, *CURLIB
Activation timer . . . . . *NOMAX         1-2550, *NOMAX
Inactivity timer . . . . . *SEC15         1-30, *ATTACH, *NOMAX...
Host print transform . . . . . *YES        *NO, *YES
Manufacturer type and model . . *IBM4312
Paper source 1 . . . . . *A4             *MFRTYPMDL, *LETTER...
Paper source 2 . . . . . *A4             *MFRTYPMDL, *LETTER...
Envelope source . . . . . *B5            *MFRTYPMDL, *MONARCH...
ASCII code page 899 support . . *NO          *NO, *YES

                                                                More...
F3=Exit  F4=Prompt  F5=Refresh  F10=Additional parameters  F12=Cancel
F13=How to use this display  F24=More keys

```

Figure 187. CRTDEVPRT for LAN-attached ASCII printer using LexLink (Part 2 of 3)

3. On the display shown in Figure 187, enter the following parameter values:

- **Activation timer:** *NOMAX

Note: If only one AS/400 system uses the printer, leave the default value (170). If more than one system shares the printer, set the value to *NOMAX, which causes the writer to wait to establish a connection.

- **Inactivity timer:** Specifies the amount of time the printer writer keeps a lock on the device before releasing it (in this example, *SEC15).

Note: If only one system is using the printer, specify *NOMAX, no need to release the printer for another system.

- **Host print transform:** *YES or *NO, but normally *YES since the spooled files from the AS/400 system must be transformed from EBCDIC to ASCII.
- **Manufacturer type, model:** Enter a value according your printer type (in this example, *IBM4312).
- **Paper source 1:** Enter your default paper format (in this example, *A4).
- **Paper source 2:** Enter your default paper format (in this example, *A4).
- **Envelope source:** Enter your default envelope format (in this example, *C5).

You can leave the default parameter values for the other parameters.

To continue, press the Page Down key. The display shown in Figure 188 appears.

```

Create Device Desc (Printer) (CRTDEVPRT)

Type choices, press Enter.

Character identifier:
  Graphic character set . . . . . *SYSVAL      1-32767, *SYSVAL
  Code page . . . . .                1-32767
  User-defined options . . . . . *NONE      Name, *NONE
    + for more values
User-defined object:
  Object . . . . . *NONE      Name, *NONE
  Library . . . . .                Name, *LIBL, *CURLIB
  Object type . . . . .                *DTAARA, *DTAQ, *FILE...
  Data transform program . . . . . *NONE      Name, *NONE
  Library . . . . .                Name, *LIBL, *CURLIB
  User-defined driver program . . . *NONE      Name, *NONE
  Library . . . . .                Name, *LIBL, *CURLIB
  Text 'description' . . . . . Device description MYPRT (NP12)

```

Bottom

Figure 188. CRTDEVPRT for LAN-attached ASCII printer using LexLink (Part 3 of 3)

4. Enter a text description for your printer configuration object. You can leave the default parameter values for the other parameters. Then press the Enter key to create the device description.

11.2.2 Configuring LAN-attached ASCII printers using PJL drivers

To be LAN attached with the PJL driver, your printer must support Printer Job Language (PJL) and PCL. See 12.1.5, “Print Job Language (PJL) support” on page 255, for more information.

Before starting the configuration, check for the following PTFs by using the Display Program Temporary Fix (DSPPTF) command:

- **V3R7**: SF43497, SF44339, and SF45336
- **V4R1 and V4R2**: Part of the base code

Note: The PJL drivers are not supported on V3R2.

To create the device description for your printer, follow these steps:

1. Type the Create Device description Printer (CRTDEVPRT) command on any command line, and press F4 (Prompt). The display shown in Figure 189 on page 242 appears.

```

                                Create Device Desc (Printer) (CRTDEVPRT)

Type choices, press Enter.

Device description . . . . . NPLAN          Name
Device class . . . . . *LAN                *LCL, *RMT, *VRT, *SNPT, *LAN
Device type . . . . . 3812                 3287, 3812, 4019, 4201...
Device model . . . . . 1                    0, 1, 2, 3, 4, 10, 13, 301...

                                                                    Bottom
F3=Exit  F4=Prompt  F5=Refresh  F10=Additional parameters  F12=Cancel
F13=How to use this display  F24=More keys

```

Figure 189. CRTDEVPRT for the LAN-attached ASCII printer using the PJI driver (Part 1 of 7)

2. On this display, enter the following parameter values:

- **Device description:** The name of your printer (in this example, NPLAN)
- **Device class:** *LAN
- **Device type:** 3812
- **Device model:** 1

Then, press the Enter key to continue. The display shown in Figure 190 appears.

```

                                Create Device Desc (Printer) (CRTDEVPRT)

Type choices, press Enter.

Device description . . . . . > NPLAN          Name
Device class . . . . . > *LAN                *LCL, *RMT, *VRT, *SNPT, *LAN
Device type . . . . . > 3812                 3287, 3812, 4019, 4201...
Device model . . . . . > 1                    0, 1, 2, 3, 4, 10, 13, 301...
LAN attachment . . . . . *IP                 *LEXLINK, *IP, *USRDFN

                                                                    Bottom
F3=Exit  F4=Prompt  F5=Refresh  F10=Additional parameters  F12=Cancel
F13=How to use this display  F24=More keys

```

Figure 190. CRTDEVPRT for LAN-attached ASCII printer using PJI driver (Part 2 of 7)

3. On this display, set the LAN attachment parameter value to *IP.

To continue, press the Enter key. The display shown in Figure 191 appears.

```

                                Create Device Desc (Printer) (CRTDEVPRT)

Type choices, press Enter.

Device description . . . . . > NPLAN           Name
Device class . . . . . > *LAN                *LCL, *RMT, *VRT, *SNPT, *LAN
Device type . . . . . > 3812                 3287, 3812, 4019, 4201...
Device model . . . . . > 1                   0, 1, 2, 3, 4, 10, 13, 301...
LAN attachment . . . . . *IP                 *LEXLINK, *IP, *USRDFN
Port number . . . . . 2501                   0-65535
Online at IPL . . . . . *YES                 *YES, *NO
Font:
  Identifier . . . . . > 11                   3, 5, 11, 12, 13, 18, 19...
  Point size . . . . . *NONE                  000.1-999.9, *NONE
Form feed . . . . . *AUTOCUT                 *TYPE, *CONT, *CUT, *AUTOCUT
Separator drawer . . . . . *FILE             1-255, *FILE
Separator program . . . . . *NONE           Name, *NONE
Library . . . . .                               Name, *LIBL, *CURLIB

                                                    Bottom
F3=Exit  F4=Prompt  F5=Refresh  F10=Additional parameters  F12=Cancel
F13=How to use this display  F24=More keys

```

Figure 191. CRTDEVPRT for the LAN-attached ASCII printer using the PJI driver (Part 3 of 7)

4. On this display, enter the following parameter values:

- **Port number:** Specify 2501 for IBM Network printers (IBM 4312, 4317, and 4324) or 9100 for all HP, Lexmark, and most IBM printers.
Note: For more information on port number, see 12.1.4, “Port number” on page 254.
- **Online at IPL:** *YES
- **Font identifier:** 11 (or another font ID used as the default font)
- **Form feed:** Specifies the form feed attachment used for this printer. Enter *AUTOCUT for a page printer or *CONT for a continuous forms printer (in this example, *AUTOCUT).

Leave the default values for the other parameters and press the Enter key to continue. The display shown in Figure 192 on page 244 appears.

```

                                Create Device Desc (Printer) (CRTDEVPRT)

Type choices, press Enter.

Device description . . . . . > NPLAN          Name
Device class . . . . . > *LAN                *LCL, *RMT, *VRT, *SNPT, *LAN
Device type . . . . . > 3812                3287, 3812, 4019, 4201...
Device model . . . . . > 1                  0, 1, 2, 3, 4, 10, 13, 301...
LAN attachment . . . . . *IP                *LEXLINK, *IP, *USRDFN
Port number . . . . . 2501                  0-65535
Online at IPL . . . . . *YES                *YES, *NO
Font:
  Identifier . . . . . > 11                  3, 5, 11, 12, 13, 18, 19...
  Point size . . . . . *NONE                 000.1-999.9, *NONE
Form feed . . . . . *AUTOCUT                *TYPE, *CONT, *CUT, *AUTOCUT
Separator drawer . . . . . *FILE            1-255, *FILE
Separator program . . . . . *NONE           Name, *NONE
Library . . . . .                          Name, *LIBL, *CURLIB
Printer error message . . . . . *INQ        *INQ, *INFO

More...

F3=Exit  F4=Prompt  F5=Refresh  F10=Additional parameters  F12=Cancel
F13=How to use this display  F24=More keys

```

Figure 192. CRTDEVPRT for the LAN-attached ASCII printer using the PJI driver (Part 4 of 7)

You can leave the default value *INQ for the Printer error message parameter.

To continue, press the Page Down key. The display shown in Figure 193 appears.

```

                                Create Device Desc (Printer) (CRTDEVPRT)

Type choices, press Enter.

Message queue . . . . . QSYSOPR          Name, QSYSOPR
  Library . . . . . *LIBL                Name, *LIBL, *CURLIB
Activation timer . . . . . 170           1-2550, *NOMAX
Inactivity timer . . . . . *SEC15        1-30, *ATTACH, *NOMAX
Host print transform . . . . . *YES        *NO, *YES

Bottom

F3=Exit  F4=Prompt  F5=Refresh  F10=Additional parameters  F12=Cancel
F13=How to use this display  F24=More keys

```

Figure 193. CRTDEVPRT for the LAN-Attached ASCII Printer using the PJI driver (Part 5 of 7)

5. On this display, enter the following parameter values:

- **Activation timer:** 170
- **Inactivity timer:** Specifies the amount of time the printer writer keeps a lock on the device before releasing it (in this example, *SEC15).

Note: If only one system is using the printer, specify *NOMAX, no need to release the printer for another system.

You can leave the default values for the other parameters.

To continue, press the Enter key. The display shown in Figure 194 appears.

```

                                Create Device Desc (Printer) (CRTDEVPRT)

Type choices, press Enter.

Message queue . . . . . QSYSOPR      Name, QSYSOPR
  Library . . . . . *LIBL          Name, *LIBL, *CURLIB
Activation timer . . . . . 170       1-2550, *NOMAX
Inactivity timer . . . . . *SEC15   1-30, *ATTACH, *NOMAX...
Inactivity timer . . . . . *ATTACH  1-30, *ATTACH, *NOMAX...
Type of parity . . . . . > *NONE    *TYPE, *EVEN, *ODD, *NONE...
Host print transform . . . . . *YES   *NO, *YES
Manufacturer type and model . . *IBM4317
Paper source 1 . . . . . *A4        *MFRTPMDL, *LETTER...
Paper source 2 . . . . . *A4        *MFRTPMDL, *LETTER...
Envelope source . . . . . *C5       *MFRTPMDL, *MONARCH...
ASCII code page 899 support . . *NO          *NO, *YES
Character identifier:
  Graphic character set . . . . *SYSVAL     1-32767, *SYSVAL
  Code page . . . . .          1-32767
                                                    More...

F3=Exit  F4=Prompt  F5=Refresh  F10=Additional parameters  F12=Cancel
F13=How to use this display  F24=More keys

```

Figure 194. CRTDEVPRT for the LAN-attached ASCII printer using the PJI driver (Part 6 of 7)

6. On this display, enter the following parameter values:
- **Manufacturer type, model:** Enter a value according your printer type (in this example, *IBM4317).
 - **Paper source 1:** Enter your default paper format (in this example, *A4).
 - **Paper source 2:** Enter your default paper format (in this example, *A4).
 - **Envelope source:** Enter your default envelope format (in this example, *C5).

You can leave the default parameter values for the other parameters.

To continue, press the Page Down key. The display shown in Figure 195 on page 246 appears.

```

                                Create Device Desc (Printer) (CRTDEVPRT)

Type choices, press Enter.

Remote location:
  Name and address . . . . . 9.99.80.145

User-defined options . . . . . *NONE      Name, *NONE
  + for more values

User-defined object:
  Object . . . . . *NONE      Name, *NONE
  Library . . . . .          Name, *LIBL, *CURLIB
  Object type . . . . .          *DTAARA, *DTAQ, *FILE...
Data transform program . . . . . *NONE      Name, *NONE
  Library . . . . .          Name, *LIBL, *CURRENT
System driver program . . . . . *IBMPJLDRV
Text 'description' . . . . . Device description for NPLAN printer

                                                                Bottom
F3=Exit  F4=Prompt  F5=Refresh  F10=Additional parameters  F12=Cancel
F13=How to use this display  F24=More keys

```

Figure 195. CRTDEVPRT for the LAN-attached ASCII printer using the PJI driver (Part 7 of 7)

7. On this display, enter the following parameter values:

- **Remote location:** The IP address of your printer (in this example, "9.99.80.145").
- **System driver program:** *IBMPJLDRV
 - Note:** For which drivers to use, depending on the target printer, see 12.1.5, "Print Job Language (PJI) support" on page 255.
- **Text 'description':** A description for your printer configuration object.

You can leave the default parameter values for the other parameters.

8. Press the Enter key to create the device description. You receive the message *Description for device NPLAN created*. If you have any problems after the configuration, see 12.1, "Communication, connection, and configuration problems" on page 253, for detailed information.

11.2.3 Configuring LAN-attached ASCII printers using SNMP drivers

With OS/400 V4R5, a new PCL driver, the SNMP driver, is added. Simple Network Management Protocol (SNMP) is a standard TCP/IP network protocol. The SNMP print driver provides the functionality of the PJI driver but does not require the target printer to support PJI commands. To use the SNMP print driver, the following rules apply:

- For the SNMP print driver to work with a specific printer, the printer must support the industry-standard Host Resource Management Information Base (RFC 1514). We highly recommend (but it is not required) that the printer also support the Printer Management Information Base (RFC 1759).
- If the printer is connected to a network adapter, the adapter must also be compatible with RFC 1514.

- If the printer is connected to an external network adapter that has more than one port, the printer should be connected to the first parallel port, and there should be no other SNMP-capable devices attached to the adapter.
- The printer and any adapter connected with the SNMP print driver must have set the community to *public*. This is normally the default setting. Read-only access to the public community is sufficient.

Note: Additional information on the SNMP print driver can be found in APAR I103291.

Support for the SNMP print driver with IBM Infoprint 21 is also available at OS/400 V4R4 and V4R3.

To create the device description for your printer, follow this process:

1. Type the Create Device description Printer (`CRTDEVPRT`) command on any command line, and press F4 (Prompt). The display shown in Figure 196 appears.

```

                                Create Device Desc (Printer) (CRTDEVPRT)

Type choices, press Enter.

Device description . . . . . NPLAN          Name
Device class . . . . . *LAN              *LCL, *RMT, *VRT, *SNPT, *LAN
Device type . . . . . 3812              3287, 3812, 4019, 4201...
Device model . . . . . 1                 0, 1, 2, 3, 4, 10, 13, 301...

                                                                Bottom
F3=Exit  F4=Prompt  F5=Refresh  F10=Additional parameters  F12=Cancel
F13=How to use this display  F24=More keys

```

Figure 196. `CRTDEVPRT` for the LAN-attached ASCII printer using the SNMP driver (Part 1 of 7)

2. On this display, enter the following parameter values:
 - **Device description:** The name of your printer (in this example, NPLAN)
 - **Device class:** *LAN
 - **Device type:** 3812
 - **Device model:** 1

Then, press the Enter key to continue. The display shown in Figure 197 on page 248 appears.

```

                                Create Device Desc (Printer) (CRTDEVPRT)

Type choices, press Enter.

Device description . . . . . > NPLAN          Name
Device class . . . . . > *LAN                *LCL, *RMT, *VRT, *SNPT, *LAN
Device type . . . . . > 3812                3287, 3812, 4019, 4201...
Device model . . . . . > 1                  0, 1, 2, 3, 4, 10, 13, 301...
LAN attachment . . . . . *IP                *LEXLINK, *IP, *USRDFN

                                                                Bottom
F3=Exit   F4=Prompt  F5=Refresh  F10=Additional parameters  F12=Cancel
F13=How to use this display  F24=More keys

```

Figure 197. CRTDEVPRT for the LAN-attached ASCII printer using the SNMP driver (Part 2 of 7)

3. On this display, set the LAN attachment parameter value to *IP.

To continue, press the Enter key. The display shown in Figure 198 appears.

```

                                Create Device Desc (Printer) (CRTDEVPRT)

Type choices, press Enter.

Device description . . . . . > NPLAN          Name
Device class . . . . . > *LAN                *LCL, *RMT, *VRT, *SNPT, *LAN
Device type . . . . . > 3812                3287, 3812, 4019, 4201...
Device model . . . . . > 1                  0, 1, 2, 3, 4, 10, 13, 301...
LAN attachment . . . . . *IP                *LEXLINK, *IP, *USRDFN
Port number . . . . . 2501                  0-65535
Online at IPL . . . . . *YES                *YES, *NO
Font:
  Identifier . . . . . > 11                  3, 5, 11, 12, 13, 18, 19...
  Point size . . . . . *NONE                 000.1-999.9, *NONE
Form feed . . . . . *AUTOCUT                *TYPE, *CONT, *CUT, *AUTOCUT
Separator drawer . . . . . *FILE            1-255, *FILE
Separator program . . . . . *NONE           Name, *NONE
Library . . . . .                            Name, *LIBL, *CURLIB

                                                                Bottom
F3=Exit   F4=Prompt  F5=Refresh  F10=Additional parameters  F12=Cancel
F13=How to use this display  F24=More keys

```

Figure 198. CRTDEVPRT for the LAN-attached ASCII printer using the SNMP driver (Part 3 of 7)

4. On this display, enter the following parameter values:

- **Port number:** Specify 2501 for IBM Network printers (IBM 4312, 4317, and 4324), or 9100 for all HP, Lexmark, and most IBM printers.

Note: For more information on port number, see 12.1.4, “Port number” on page 254.

- **Online at IPL:** *YES
- **Font identifier:** 11 (or another font ID used as the default font)
- **Form feed:** Specifies the form feed attachment used for this printer. Enter *AUTOCUT for a page printer or *CONT for a continuous forms printer (in this example, *AUTOCUT).

Leave the default values for the other parameters, and press the Enter key to continue. The display shown in Figure 192 appears.

```

                                Create Device Desc (Printer) (CRTDEVPRT)

Type choices, press Enter.

Device description . . . . . > NPLAN          Name
Device class . . . . . > *LAN              *LCL, *RMT, *VRT, *SNPT, *LAN
Device type . . . . . > 3812              3287, 3812, 4019, 4201...
Device model . . . . . > 1                0, 1, 2, 3, 4, 10, 13, 301...
LAN attachment . . . . . *IP              *LEXLINK, *IP, *USRDFN
Port number . . . . . 2501                0-65535
Online at IPL . . . . . *YES              *YES, *NO
Font:
  Identifier . . . . . > 11                3, 5, 11, 12, 13, 18, 19...
  Point size . . . . . *NONE              000.1-999.9, *NONE
Form feed . . . . . *AUTOCUT             *TYPE, *CONT, *CUT, *AUTOCUT
Separator drawer . . . . . *FILE          1-255, *FILE
Separator program . . . . . *NONE         Name, *NONE
  Library . . . . . *LIBL, *CURLIB
Printer error message . . . . . *INQ      *INQ, *INFO

More...
F3=Exit  F4=Prompt  F5=Refresh  F10=Additional parameters  F12=Cancel
F13=How to use this display  F24=More keys

```

Figure 199. CRTDEVPRT for the LAN-attached ASCII printer using the SNMP driver (Part 4 of 7)

You can leave the default value *INQ for the printer error message parameter. To continue, press the Page Down key. The display shown in Figure 200 appears.

```

                                Create Device Desc (Printer) (CRTDEVPRT)

Type choices, press Enter.

Message queue . . . . . QSYSOPR          Name, QSYSOPR
  Library . . . . . *LIBL                Name, *LIBL, *CURLIB
Activation timer . . . . . *NOMAX         1-2550, *NOMAX
Inactivity timer . . . . . *SECL5        1-30, *ATTACH, *NOMAX
Host print transform . . . . . *YES       *NO, *YES

Bottom
F3=Exit  F4=Prompt  F5=Refresh  F10=Additional parameters  F12=Cancel
F13=How to use this display  F24=More keys

```

Figure 200. CRTDEVPRT for the LAN-Attached ASCII printer using the SNMP driver (Part 5 of 7)

5. On this display, enter the following parameter values:

- **Activation timer:** *NOMAX

Note: If only one AS/400 system uses the printer, use the default value (170 seconds). If more than one system shares the printer, set the value to *NOMAX, which causes the AS/400 system to wait to establish a connection.

- **Inactivity timer:** Specifies the amount of time the printer writer keeps a lock on the device before releasing it (in this example, *SEC15).
Note: If only one system is using the printer, specify *NOMAX. There is no need to release the printer for another system.
- **Host print transform:** *YES or *NO, but normally *YES as the spooled files from the AS/400 system must be transformed from EBCDIC to ASCII.

You can leave the default values for the other parameters.

To continue, press the Enter key. The display shown in Figure 201 appears.

```

                                Create Device Desc (Printer) (CRTDEVPRT)

Type choices, press Enter.

Message queue . . . . . QSYSOPR      Name, QSYSOPR
  Library . . . . . *LIBL          Name, *LIBL, *CURLIB
Activation timer . . . . . 170       1-2550, *NOMAX
Inactivity timer . . . . . *SEC15   1-30, *ATTACH, *NOMAX...
Inactivity timer . . . . . *ATTACH  1-30, *ATTACH, *NOMAX...
Type of parity . . . . . > *NONE   *TYPE, *EVEN, *ODD, *NONE...
Host print transform . . . . . *YES   *NO, *YES
Manufacturer type and model . . . *IBM4317
Paper source 1 . . . . . *A4       *MFRTYPMDL, *LETTER...
Paper source 2 . . . . . *A4       *MFRTYPMDL, *LETTER...
Envelope source . . . . . *C5      *MFRTYPMDL, *MONARCH...
ASCII code page 899 support . . *NO      *NO, *YES
Character identifier:
  Graphic character set . . . . *SYSVAL  1-32767, *SYSVAL
  Code page . . . . .          1-32767
                                                More...

F3=Exit  F4=Prompt  F5=Refresh  F10=Additional parameters  F12=Cancel
F13=How to use this display  F24=More keys

```

Figure 201. CRTDEVPRT for the LAN-attached ASCII printer using the SNMP driver (Part 6 of 7)

6. On this display, enter the following parameter values:

- **Manufacturer type, model:** Enter a value according your printer type (in this example, *IBM4317).
- **Paper source 1:** Enter your default paper format (in this example, *A4).
- **Paper source 2:** Enter your default paper format (in this example, *A4).
- **Envelope source:** Enter your default envelope format (in this example, *C5).

You can leave the default parameter values for the other parameters.

To continue, press the Page Down key. The display shown in Figure 202 appears.

```

                                Create Device Desc (Printer) (CRTDEVPRT)

Type choices, press Enter.

Remote location:
  Name and address . . . . . 9.99.80.145

User-defined options . . . . . *IBMSHRCNN   Name, *NONE
  + for more values

User-defined object:
  Object . . . . . *NONE                 Name, *NONE
  Library . . . . .                          Name, *LIBL, *CURLIB
  Object type . . . . .                      *DTAARA, *DTAQ, *FILE...
  Data transform program . . . . . *NONE                 Name, *NONE
  Library . . . . .                          Name, *LIBL, *CURRENT
  System driver program . . . . . *IBMSNMPDRV
  Text 'description' . . . . . Device description for NPLAN printer

                                                                    Bottom
F3=Exit  F4=Prompt  F5=Refresh  F10=Additional parameters  F12=Cancel
F13=How to use this display  F24=More keys

```

Figure 202. CRTDEVPRT for the LAN-attached ASCII printer using the SNMP driver (Part 7 of 7)

7. On this display, enter the following parameter values:

- **Remote location:** The IP address of your printer (in this example, 9.99.80.145).
- **User-defined options:** *IBMSHRCNN causes the SNMP print driver to open and close the data port on the printer for every copy of every spooled file. This enables multiple writers and systems to share the printer. If this option is specified, the Inactivity Time is ignored. This option must be specified for the IBM Infoprint 21 printer.
- **System driver program:** *IBMSNMPDRV
 - Note:** For which drivers to use, depending on the target printer, see 12.1.5, “Print Job Language (PJM) support” on page 255.
- **Text 'description':** A description for your printer configuration object.

You can leave the default parameter values for the other parameters.

8. Then, press the Enter key to create the device description. You receive the message `Description for device NPLAN created.` If you have any problems after the configuration, see 12.1, “Communication, connection, and configuration problems” on page 253, for detailed information.

Chapter 12. Problem determination techniques

This chapter discusses problems related to installing and driving printers. It also presents methods and techniques that may be used to isolate the source of the problems. It points to various documentation sources where additional information can be found. It is not, however, a substitute for problem-determination methods described in the system, device manuals, or online help.

No performance problems are discussed in this chapter. However, you can find details of this in Appendix A, "PSF/400 performance factors" on page 279.

For detailed information on printer configuration, see Chapter 11, "Configuring LAN-attached printers" on page 223. If you are using a remote output queue, see Chapter 8, "Remote system printing" on page 171.

12.1 Communication, connection, and configuration problems

This topic covers printer problems related to communication, connection, and configuration. For the different printer attachment methods, see 1.4, "AS/400 printer attachment methods" on page 15.

12.1.1 Setting up a TCP/IP network on the AS/400 system

To drive a TCP/IP attached printer, the TCP/IP subsystem must be properly configured and has to be up and running. Use the following steps to set up a TCP/IP network on the AS/400 system:

1. Create a Token-Ring or Ethernet line description using the `CRTLINTRN` or `CRTLINETH` command.
2. Vary on the line description using the `VRFCFG` command.
3. Add a TCP/IP interface using the `ADDTCPIFC` command.
4. Start TCP/IP interface using the `STRTCPIFC` command.
5. Add a TCP/IP route definition, if necessary, using the `ADDTCPRTE` command.
6. Start TCP/IP with the `STRTCP` command.

If your TCP/IP network is already implemented, use the `WRKACTJOB` command to check if QTCPIP is running. If it is not running, use the `STRTCP` command to start it.

12.1.2 SSAP values in the line description

Use the `DSPLIND` command to check the Source Service Access Points (SSAP) values in the line description according to the type of communication used. Keep these points in mind:

- You must have the following SSAP entries when attaching IPDS printers or ASCII printers using the PJI drivers (Version 3.0 Release 7.0 or later), or using remote system printing with a connection type of *IP:

```
SSAP 12 *MAXFRAME *NONSNA
SSAP AA *MAXFRAME *NONSNA
```

- The line description must contain the following SSAP entries when attaching ASCII printers using the Lexlink protocol (using a Lexmark Internal Network Adapter or a MarkNet XLe external LAN adapter):

```
SSAP 12 *MAXFRAME *NONSNA
SSAP 16 *MAXFRAME *NONSNA
SSAP 1A *MAXFRAME *NONSNA
```

12.1.3 Pinging the TCP/IP address

When the configuration is completed, test the TCP/IP connection using the PING command on the AS/400 system with the IP address of your printer:

```
PING '123.1.2.3'
```

- If the PING is successful, vary on the printer:

```
VRYCFG CFGOBJ(Printer_dev) CFGTYPE(*DEV) STATUS(*ON)
```

Then start the print writer (if not using a remote output queue):

```
STRPRTWTR DEV(Printer_dev)
```

If you are using a remote output queue, enter:

```
STRRMWTR DEV(Printer_dev)
```

Print a job as a test (for example, a print screen). If this fails to print, continue with the following section.

- If the PING fails, perform these actions:
 - a. Verify the configurations of the AS/400 system, TCP/IP subsystem, the printer, and any intervening devices such as routers. Can you PING any of these devices? Then contact your LAN coordinator for assistance.
 - b. Verify that the AS/400 LAN adapter card and printer hardware are fully operational. Use the `WRKTCPSTS` command to access a menu of useful commands, including the option to check whether the TCP/IP interface with your LAN adapter card is active (Work with TCP/IP interface status).
 - c. Check the IP address of the printer LAN card (printer setup) and the one specified in the AS/400 configuration.

12.1.4 Port number

The port number is important for connecting the printer. The value varies according to the printer type. The TCP/IP port parameter is in the PSF configuration object in Version 3.0 Release 2.0 and in the device description in Version 3.0 Release 7.0 and later.

Note: The port number is a parameter of the `WRKAFF2` command in Version 3.0 Release 1.0 and Version 3.0 Release 6.0.

The following port numbers are used according to the printer type and the attachment method:

5001	IBM IPDS printer on the LAN (TCP/IP)
2501	IBM Network Printers (4312, 4317, 4324) and IBM Infoprint printers (4320, 4322, 4332) in ASCII mode, network-attached, and using the PJI print driver

9100 IBM Infoprint Color 8, older IBM laser printers (for example, 4039), all HP, all Lexmark in ASCII mode, network-attached, and using the PJL driver

Note: If the printer LAN attachment card (internal or external) has more than one entry, the port number can be 9100, 9101, or 9102.

If none of these values is successful, consult your printer's manufacturer to determine if your printer has a dedicated port that accepts PCL/PJL commands.

12.1.5 Print Job Language (PJL) support

The following printers support PCL and PJL and can be TCP/IP LAN-attached using the PJL drivers (Version 3.0 Release 7.0 and later):

- IBM 4039 Plus and IBM Network Printer 12, 17, and 24
- Lexmark Optra family
- HP LaserJet III Si
- HP LaserJet 4, 5, and 6 family

Note: There is no PJL support on early IBM 4039 models nor on the HP LaserJet III.

If PJL is not supported, the message CPD337F is returned. If in doubt, consult your printer's manufacturer to determine if your printer supports PCL and PJL.

Use the *IBMPJLDRV driver for all IBM printers (for example, IBM Network Printer 12 and 17 and Infoprint 20 and 32). Note that IBM Infoprint 12 does not support PJL.

Use the *HPPJLDRV driver for all HP and HP compatible printers.

12.1.6 Message PQT3603

The message PQT3603 is issued for a connection problem with a LAN-attached IPDS printer configured as AFP(*YES). The message PQT3603 includes the name of the printer, the remote location name, and an error code defining the failed condition. For an example, see Figure 203.

```
Message . . . . : Connection with device PRT1 cannot be established.  
Cause . . . . : A session cannot be established with the device at  
RMTLOCNAME PRT1B02, using PORT 5001. The error code is 10.
```

Figure 203. Message PQT3603

Depending on the error code, perform the following recovery actions:

- **10:** The specified remote location name (RMTLOCNAME) was rejected.
Specify a correct remote location name. This is either the IP address of the printer or its corresponding name in a host table entry list. Verify that the IP address at the device and the remote location name in the PSF configuration object (Version 3.0 Release 2.0) or in the printer device description (Version 3.0 Release 7.0 and later) are the same. If you are using a RMTLOCNAME name, check the IP address in the TCP/IP host table.
- **15:** The activation timer (ACTTMR) value configured for the device expired before the device was available.

Increase the value for ACTTMR in the PSF configuration object (Version 3.0 Release 2.0) or in the printer device description (Version 3.0 Release 7.0 and later), or determine if your network has a problem.

- **22:** The device did not respond to a connection request.

The device may not be able to accept a connection request because:

- Another writer (possibly on another system) is sending it data.
- It is in the process of ending a connection with another writer.
- It is in an error condition on another system.
- The device is configured on another system where sharing of the device has not been configured.

If the device has a connection with another writer or the device is in the process of ending a connection with another writer, this is a normal error code.

Otherwise, verify that the port number (PORT) specified in the PSF configuration object (Version 3.0 Release 2.0) or in the printer device description (Version 3.0 Release 7.0 and higher) matches the port number specified at the device. If these values match, you may need to reset the device before starting the writer.

Also refer to the information in the following point on error codes 20-39. If the problem continues, report it using the ANZPRB command.

- **20-39:** A communications failure occurred.

Verify configuration values and check for problems in your network. Consider increasing the value specified for RETRY in the PSF configuration object used.

If a PSF configuration object is not in use, create one (use the CRTPSFCFG command). In Version 3.0 Release 2.0, the PSF configuration object must have the same name as the printer. In Version 3.0 Release 7.0 and later, specify the name of the PSF configuration object in the printer device description using the USRDFNOBJ parameter.

After correcting the problem, start the printer writer to begin processing again. If the problem continues, report it using the ANZPRB command.

- **41-59:** An internal failure occurred.

These error codes (and especially **46**) occur with:

- A hardware problem on the printer.
- Down-level printer microcode levels. Install the latest one for ETH or TR, CTL, and IPDS. Print the printer configuration page to see the level of the installed microcode.
- Check any routers and their definitions, any switch box or hubs, and cabling.

Note: If no error code is returned in the message PQT3603, perform the same actions as for error code 41-59.

After correcting the problem, start the printer writer to begin processing again. If the problem continues, report it using the ANZPRB command.

12.1.7 Configuring LAN-attached IPDS printers

The configuration of IPDS LAN attached printers to an AS/400 system has changed with different versions and releases:

- **Configuring LAN-attached IPDS printers on Version 3.0 Release 1.0**

On Version 3.0 Release 1.0, you need a device description (CRTDEVPRT) and a data area created by the WRKAFF2 command. You must first create the WRKAFF2 command. The instructions to create and use it are in the cover letter of PTF SF29961. The source code for the command is also included in this cover letter. The name of the data area must be the same as the printer name.

- **Configuring LAN-attached IPDS printers on Version 3.0 Release 2.0**

On Version 3.0 Release 2.0, you need a device description (CRTDEVPRT) and a PSF configuration object (CRTPSFCFG). The name of the PSF configuration must be the same as the name of the printer.

Note: If you migrate from Version 3.0 Release 1.0 to Version 3.0 Release 2.0, during the first Start Printer Writer (STRPRTWTR), a PSF configuration object is automatically created by the system and includes the WRKAFF2 data area values (used in V3R1). This PSF configuration object is placed in the library QGPL and has the same name as the printer device description.

- **Configuring LAN-attached IPDS printers on Version 3.0 Release 6.0**

On Version 3.0 Release 6.0, you need a device description (CRTDEVPRT) and a data area created by the WRKAFF2 command. You must first create the WRKAFF2 command. The instructions to create and use it are in the cover letter of PTF SF31461. The source code for the command is also included in this cover letter. The name of the data area must be the same as the printer name.

- **Configuring LAN-attached IPDS printers on Version 3.0 Release 7.0 and later**

On Version 3.0 Release 7.0 and later, you need a device description (CRTDEVPRT) and a PSF configuration object (CRTPSFCFG). The name of the PSF configuration can be any name, but this object must be referenced in the USRDFNOBJ parameter of the device description.

The RMTLOCNAME, PORT, and ACTTMR parameters are now part of the printer device description. However, they still appear in the CRTPSFCFG Version 3.0 Release 7.0 and Version 4.0 Release 1.0, but are not used here. Take care that you enter the values for these parameters in the correct place (that is, the device description).

Note: If you migrate from earlier releases of OS/400 to Version 3.0 Release 7.0 or later, we recommend that you:

- Delete existing printer device descriptions.
- Delete existing data areas created by the WRKAFF2 command (V3R1 and V3R6).

Re-create new printer device descriptions and new PSF configuration objects.

For detailed information on printer configuration, see 11.1, “Configuring LAN-attached IPDS printers” on page 223.

12.1.8 Configuring for remote system printing

Some printers are unable to accept host printing commands directly, but must have them interpreted by another process. The line printer daemon (LPD) is one such common process, and is frequently used when printing to an ASCII LAN-attached printer using some kind of LAN adapter (for example, a JetDirect card or external box). The daemon runs inside the card and is regarded as another system as far as OS/400 is concerned.

To print to such a remote “system”, you need to create a *remote output queue* using the normal Create Output Queue (CRTOUTQ) command. The most common problems result from the wrong *print queue* name. See 12.1.9, “Remote printer queue names” on page 258, for details. Also check for the correct destination options to avoid timeout problems or the wrong number of copies. This is covered in 8.2.2, “Destination options” on page 176.

If host print transform is used and if the page size parameter in your printer file does not match a page size entry in the WSCST table, the letter format is used as the default format. In this case, the printer may display the message “Load Letter”. See 8.2.4, “‘Load Letter’ message on the printer” on page 179, for workarounds to this problem.

Note: If possible, attach your remote ASCII printers using the PJI drivers (Version 3.0 Release 7.0 and later) instead of a remote output queue. This provides greater functionality. See 11.2.2, “Configuring LAN-attached ASCII printers using PJI drivers” on page 241, for detailed information.

12.1.9 Remote printer queue names

If you are using a remote output queue with a connection type *IP and a destination type *OTHER to attach an ASCII printer using TCP/IP, you must specify the name of the remote printer queue on the target system. This name varies depending on the device supplying the LPD function.

Note: This also applies if you use the SNDTCPSPLF command.

Table 22 shows some of the more frequently-encountered printer queue names.

Table 22. Internal print queue names for selected print devices

Interface used	Queue name
HP JetDirect Card (internal)	'text' for unformatted output 'text' for formatted output
HP JetDirect Server (external) (3 ports - 1 IP address)	'text1' or 'raw1' for port 1 'text2' or 'raw2' for port 2 'text3' or 'raw3' for port 3
Integrated Network Option (IBM 4039, 3112, 3116, Lexmark OPTRA)	'pro0'
Lexmark MarkNet XLe	'prt1' for parallel 1 'prt2' for parallel 2 'prt9' or 'ser' for serial port
IBM Network Print Server	'prt1'.....'prt8' - 8 logical parts
IBM Network printer (4312, 4317, 4324) IBM Infoprint Printers (4320, 4322, 4332)	PASS (or TEXT if PASS does not work)

Interface used	Queue name
IBM Infoprint 12	'raw'
IBM Infoprint Color 8	PASS (or TEXT if PASS does not work)
IBM 3130	'afccu2'
Intel Netport XL	TEXT1 for parallel port 1 TEXT2 for parallel port 2
Intel Netport Pro	LPTx_PASSTHRU - Where x = port LPTx_TEXT - Where x = port
UNIX/RISC	printer queue name (case sensitive)

Note: You *must* use these names for a successful connection. They are hard-coded into the LPD daemons, unlike OS/400 where an output queue name may be (almost) anything you want.

12.2 Printer-writer-related problems

This topic relates to print writer problems. Normally, the job log may give you the necessary information to correct the problem (for example, prompting you to answer any non-answered messages). You can check the status of the writers using the WRKWTR command, the status of the spooled files with the WRKSPLF or WRKOUTQ command, and the status of the output queue with the WRKOUTQ command. The information provided by these commands is discussed in the following sections.

12.2.1 Print writer ends

If the printer ends unexpectedly, a job log is sent to the QEZJOBLOG output queue (or two job logs for an AFP print writer). The reported messages can help you to find the problem. It may be as minor as someone switching off the printer (for example, to clear a paper jam). To check that a printer called NP17 is powered on and varied on, enter:

```
WRKCFGSTS *DEV NP17
```

The display shown in Figure 204 appears.

```

                                Work with Configuration Status
                                SYS00005
                                11/14/97 15:36:33
Position to . . . . . Starting characters

Type options, press Enter.
 1=Vary on   2=Vary off   5=Work with job   8=Work with description
 9=Display mode status 13=Work with APPN status...

Opt Description      Status      -----Job-----
   NP17              VARIED ON

```

Figure 204. Work with Configuration Status display

If the printer status is VARIED OFF, use option 1 (Vary On). Use the Help key for an explanation of the different statuses that are possible.

If you still have a problem, the following reasons are some of the typical causes of the writer ending:

- **Duplicate IP address**

After configuring a LAN-attached printer, the PING test may be OK, but when you try to print, the print writer ends immediately.

In this case, check for a duplicate IP address:

a. Disconnect the printer (at the printer end, for example, remove the LAN cable).

b. Ping the IP address of the printer:

```
PING '123.1.2.3'
```

c. If the PING is successful, you have a duplicate address. Contact your LAN coordinator.

If the PING is unsuccessful (as it should be), reconnect the printer and check the writer job log for any messages.

- **Message queue full**

The printer writer ends immediately after a STRPRTWTR command. No message or job log is available. This can happen when the message queue associated with the printer is full. When the message queue is full, even the normal start writer message cannot be written to the queue. Therefore, the writer ends.

Use the `DSPDEV` command to display the message queue name associated with the printer, and then use the `WRKMSGQ` command (change, view, and clear options available).

- **Activation timer - Release timer**

If you are sharing a printer with another system, the activation timer and the release timer can be the reason that the print writer ends. When sharing a printer, these two parameters must contain the following values:

– **ACTTMR**: Activation Timer (printer device description).

This parameter should be set to `*NOMAX`. With this value, you can wait indefinitely until another system using the printer releases it.

– **RLSTMR**: Release Timer (PSF configuration object):

This parameter should be set to `*SEC15`.

Note: If this value is `*NOMAX`, the first system accessing the printer does not release it, and any other systems cannot use it.

12.2.2 Spooled files remain in RDY status

Using the `WRKWTR` command, you can see that the writer is STR (Started), but the spooled file remains RDY (Ready) on your output queue with no printing.

In this case, check the status of the output queue. Use the `WRKOUTQ` command, and check the status in the upper right corner of the Work with Output Queue display. The status must be RLS/WTR. See Figure 206 on page 263 for an example of this display.

- If the status is HLD, the queue is held and no writer is started to the queue. Use the RLSOUTQ command to release the output queue. You can now start a writer to the queue using the STRPRTWTR command.
- If the status is HLD/WTR, the queue is held and a writer is started to the queue. Use the RLSOUTQ command to release the output queue.
- If the status is RLS, the queue is released, but no writer is started to the output queue. Start the writer using the STRPRTWTR command. If you have already done this, the writer is probably ending immediately. Refer to 12.2.1, “Print writer ends” on page 259.
- If the status is RLS/WTR, the queue is released and a writer is started to the queue. Be patient! The status of the spooled file must change from RDY to WTR if the target printer is configured AFP(*NO), or from RDY to PND to WTR, and then to PRT if the target printer is configured AFP(*YES). The spooled file should then be printed.

Tip

From a WRKOUTQ display, you can use option 9 (Work with printing status) to perform *all* the previous commands. However, using a guided, step-by-step process tells you exactly what to do next, instead of wondering whether to use WRKWTR, WRKSPLF, and so on. Learn to use this option.

12.2.3 Spooled file remains in PND status

Using the WRKWTR command, you can see that the writer is in STR (Started) status, but the spooled file remains in PND (Pending) status in your output queue. Nothing is printed. In this case, the print driver job (PDJ) cannot establish a connection with the printer (it is waiting for an answer from the printer). Therefore, you need to complete these steps:

1. End the writer (see the next section).
2. Power off the printer.
3. Wait approximately 10 seconds (to avoid causing LAN problems).
4. Power on the printer.
5. Start the print writer again.

12.2.4 Ending the writer

To end the writer immediately, enter the following command:

```
ENDWTR WTR(printer_name) OPTION(*IMMED)
```

This end of job forces a job log. If you forget the *IMMED option, you can issue the command again, but this time with the option.

To end the writer abnormally (if the previous command does not work), enter:

```
CALL QSPENDWA printer-name
```

This is rarely needed.

12.2.5 Spooled file status

Figure 205 shows the status for a spooled file from its creation up to its printing (or transmission to another system (remote system printing)). To check the status of a spooled file, use the `WRKSELPF` or the `WRKOUTQ` command.

Figure 205 also shows the spooled file status when the target printer is configured AFP(*NO), AFP(*YES) with PSF/400, and if remote system printing is used.

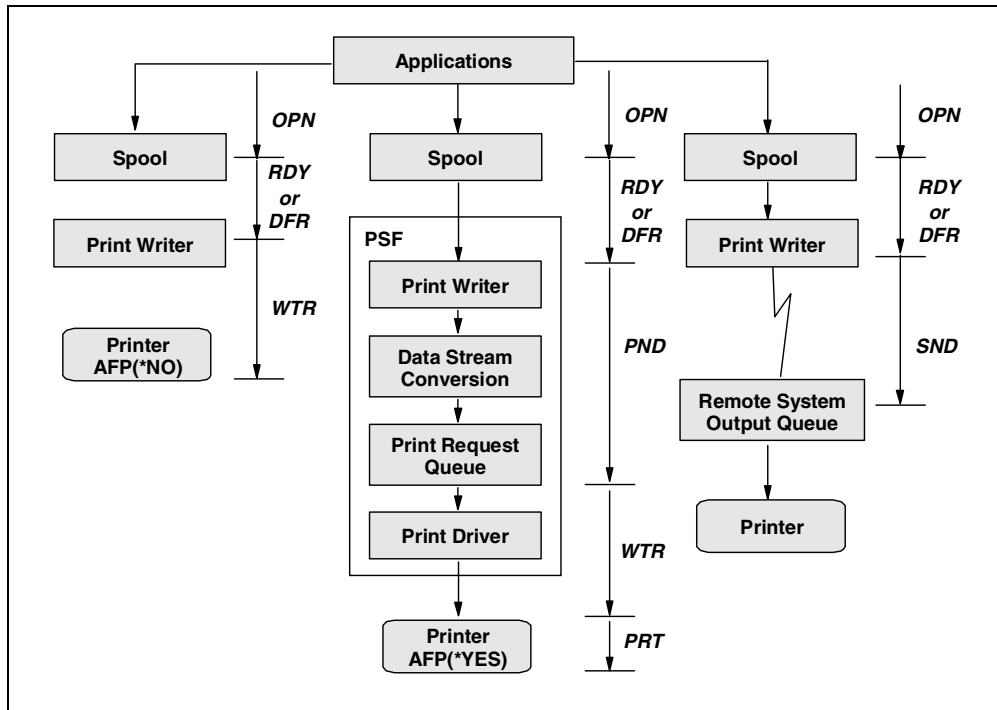

Figure 205. Spooled file status

Figure 205 shows only some of the main statuses that are possible. A complete list of all spooled file statuses follows:

- OPN** Open: The file has not been completely processed and is not ready to be selected by a writer.
- RDY** Ready: The file is available to be written to an output device by a writer.
- DFR** Deferred: The file has been deferred from printing.
- SND** Sending: The file is being or has been sent to a remote system.
- CLO** Closed: The file has been completely processed by a program, but `SCHEDULE(*JOBEND)` was specified and the job that produced the file has not yet finished.
- HLD** Held: The file has been held.
- SAV** Saved: The file has been written and then saved. This file will remain saved until it is released.
- PND** Pending: The file is in the conversion phase, or pending to be printed. You can have more than one spooled file in PND status in an output queue.

- WTR** Writer: This file is currently being produced by the writer on an output device.
- PRT** Printing: The file has been sent to the printer, but print complete status has not yet been sent back to the system.
- MSGW** Message Waiting: This file has a message that needs a reply or an action to be taken.

The following status values with a * (asterisk) in front of them are displayed when an action is performed on the file as a result of selecting an option:

- *CHG** Changed: This file was changed using option 2 (Change).
- *HLD** Held: This file was held using option 3 (Hold).
- *RLS** Released: This file was released using option 6 (Release).

12.2.6 Output queue status

The status of the output queue can also tell you whether a writer is started to the queue. Use the `WRKOUTQ` command. The display shown in Figure 206 appears.

```

Work with Output Queue

Queue:  PRT01          Library:  QUSRSYS          Status:  RLS/WTR

Type options, press Enter.
  1=Send  2=Change  3=Hold  4=Delete  5=Display  6=Release  7=Messages
  8=Attributes          9=Work with printing status

Opt  File           User           User Data  Sts  Pages  Copies  Form Type  P
-----
TESTOUTQ  DBAS             RDY         1      1      1      *STD
MODEL     JENNY            RDY         1      1      1      *STD
TESTIN    LEGS             HLD         1      1      1      *STD
QSYSPRT   DBAS             HLD         1      1      1      *STD
QSYSPRT   SANDY            HLD         1      1      1      *STD
QSYSPRT   SANDY            HLD        346     1      1      *STD
FAXPRT    DEBBIE           HLD         1      1      1      *STD

Parameters for options 1, 2, 3 or command
====>
F3=Exit  F11=View 2  F12=Cancel  F20=Writers  F22=Printers
F24=More keys

```

Figure 206. Work with Output Queue display

In the top right-hand corner, the *Status* field refers to the status of the output queue (RLS - Released) and the status of the print writer (WTR - Writing) in this example.

The following list contains all of the output queue status.

- HLD** Held: The queue is held.
- HLD/WTR** Held/Writer: The queue is attached to a writer and is held.
- RLS/WTR** Release/Writer: The queue is attached to a writer and is released.
- RLS** Released: The queue is released, and no writer is attached.

12.2.7 AFCCU printers: Minimize delay when stopping and starting

The AFCCU printers include Infoprint 60, Infoprint 62, Infoprint 2000, Infoprint 3000, and Infoprint 4000. They have a configuration option called “Clear Memory for Security”. This option can have a significant impact on the time required to start the printer after it has been stopped by PSF and the printer subsystem.

To prevent unnecessary delay when starting and stopping AFCCU printers, set this option to “NO” unless you have extraordinary security requirements. “YES” requires the printer to zero out all print data storage when the printer is restarted. This is not required for normal security because pointers to the data are no longer active. This has been the standard for IPDS printers and, until AFCCU, has had little impact on performance. Now, with the large amount of storage in AFCCU printers, clearing can take several minutes, enough to make a noticeable difference to customers who start and stop their printers multiple times a day.

Note: “YES” is the default setting for this option on all current AFCCU printers. There are plans to use “NO” as the setting for future printers.

12.2.8 QSTRUP execution during IPL

This section contains references to the QSTRUP program that runs at IPL time. It is divided into two sections. The first section changes the message logging of the job log to increase job log information for diagnostic uses. The second section has example changes to the program pertaining to the spooling functions on the system.

12.2.8.1 Tracking the QSTRUP program at IPL

Follow this process:

1. Analyze the problem. In this case, the writer is not starting during the startup routine at IPL.
2. Make a diagnosis. Check the QSTRUPJD job in the QEZJOBLOG output queue for messages relating to the device description not varied on or writer not starting. If the logging is not there or not complete enough, change the job description for the next IPL. Use the CHGJOB QSTRUPJD command as follows:

```
CHGJOB JOB(QSTRUPJD) LOG(4 0 *SECLVL) LOGCLPGM(*YES)
```

Note: The job identifier in the QEZJOBLOG output queue is:

```
job number/QPGMR/QSTRUPJD.
```

12.2.8.2 Changing the QSTRUP program

Follow this process:

1. On the OS/400 command line, type:

```
DSPSYSVAL QSTRUPPGM
```

This displays the name and library of the active startup program for the AS/400 system. It usually points to QSYS/QSTRUP.

2. On the OS/400 command line, type:

```
RTVCLSRC PGM(QSYS/QSTRUP) SRCFILE(QGPL/QCLSRC)
```

This retrieves the CL source of the startup program from step 1.

3. On the OS/400 command line, type:

```
STRSEU SRCFILE(QGPL/QCLSRC) SRCMBR(QSTRUP)
```

Edit the CL source that you extracted from the program. Look for QSYS/STRPRTWTR DEV(*ALL) in the source. This starts all the printers with the defaults. Insert the specific printer on a line just before the QSYS/STRPRTWTR command, for example:

```
QSYS/STRPRTWTR DEV(printer_name) ALIGN(*FILE)
```

Note: If the STRPRTWTR command is not being used, look for the QWCSWTRS program. This is an alternative approach to start writers. It checks to see if a device description is varied on before trying to start the writer. Review Informational APAR II09679 for details (this APAR can be downloaded as a PTF cover letter). This is a good solution for writers not starting at IPL. It loops through the device description 30 times to see if they are varied on. The STRPRTWTR command checks only once and then passes by.

4. On the OS/400 command line, type:

```
CRTCLPGM PGM(QSYS/QSTRUP) SRCMBR(*PGM)
```

Note: This writes over the system default QSTRUP program. If you do not want to overwrite it, proceed to the next step.

5. If you do not want to overwrite the default QSTRUP program, on the OS/400 command line, type the following command:

```
CRTCLPGM PGM(library/QSTRUP) SRCMBR(*PGM)
```

Note: A good choice for the library is QGPL.

6. Change the system value QSTRUPPGM to refer to the new program. On the OS/400 command line, type:

```
CHGSYSVAL QSTRUPPGM VALUE('QSTRUP library')
```

At the next IPL, the printers should be started correctly.

12.3 Where your print output goes

The elements that control printing have a defined hierarchy. Figure 207 on page 266 shows that hierarchy. In the diagram, you can see that the system looks at the elements in this order: printer file, job description, user profile, workstation description, and system value. The system looks first for the output queue and print device in the printer file.

It is important to know and remember the following conditions:

- If the spooled parameter is set to *YES in the printer file, the output must go to an output queue. In this case, the first output queue name specified (according to the hierarchy) is used.
- If the spooled parameter is set to *NO in the printer file, the output must go to a device. In this case, the first device specified (according to the hierarchy) is used.

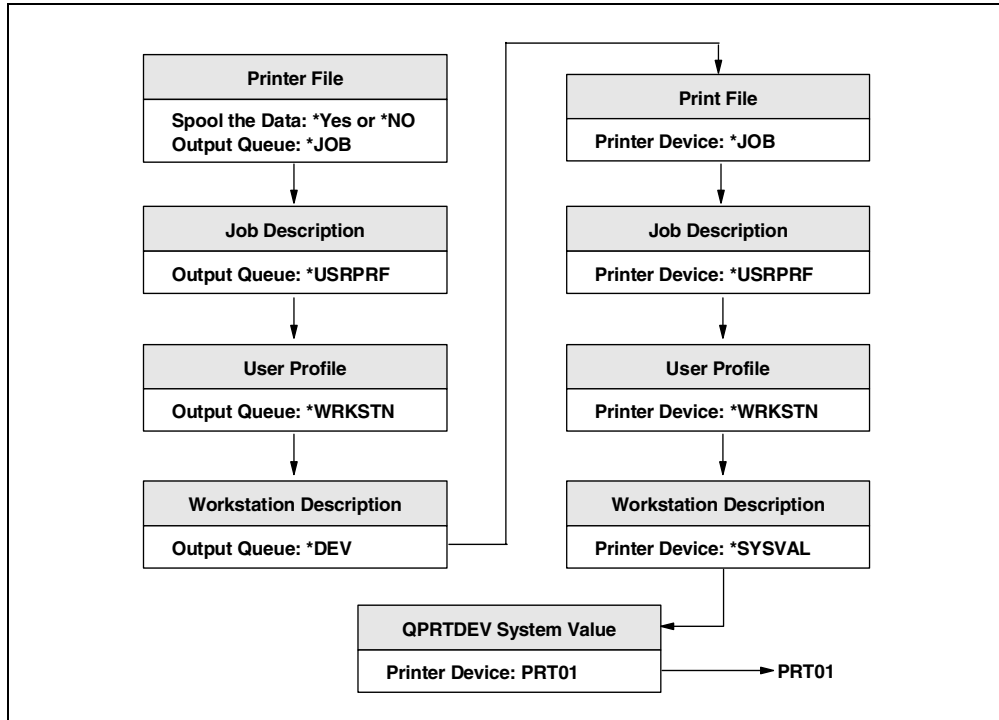

Figure 207. Hierarchy of the elements controlling printing

In the example shown in Figure 208, we assume that the SPOOL parameter is set to *YES. This means the system will search for an output queue. The first one found according to the hierarchy of the printing elements is PRT04 in the job description. PRT04 is used as the output queue by the application.

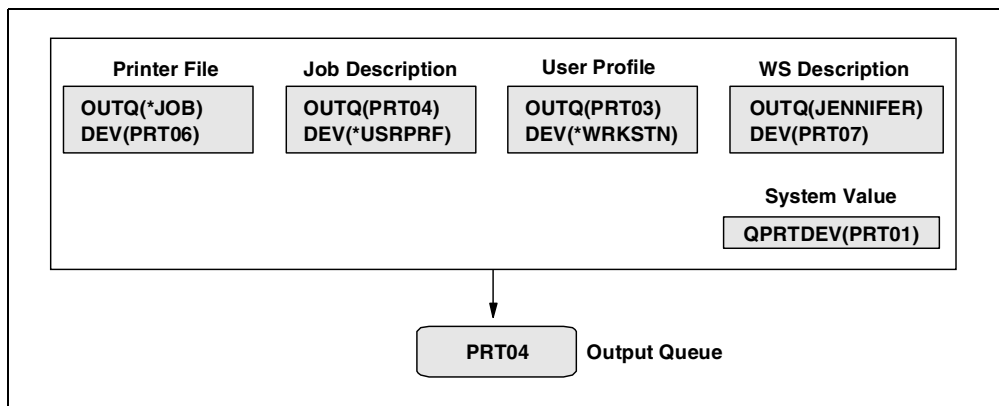

Figure 208. Example of where your print output goes

12.4 Spooled file goes to hold status

If the spooled file is in a hold condition, a message is generated in the QSYSOPR job log. To see the reported message, type:

```
DSPMSG QSYSOPR
```

Then locate the message and perform the appropriate action. Many factors can cause the spooled file to be held (for example, directing a spooled file to a printer not supporting the data stream, a negative acknowledgment reported by an IPDS printer, or AFP resources not found). The printer writer is trying to help you by not allowing you to print invalid or missing data!

In the QSYSOPR message queue, you see message CPF3395 (Figure 209), indicating that the spooled file was held.

```
Message ID . . . . . : CPF3395      Severity . . . . . : 60
Message type . . . . . : Information
Date sent . . . . . : 11/16/97      Time sent . . . . . : 10:08:40

Message . . . . . : File QSYSPRT held by writer PRT02 on output queue PRT02 in
QUSRSYS.
Cause . . . . . : Writer PRT02 held file QSYSPRT number 2 job
026403/ITSCID17/QPADEV0010 on output queue PRT02 in QUSRSYS. The next file
was processed.
```

Figure 209. Message CPF3395

Another message just before CPF3395 gives the cause of the error. Some examples are illustrated in the following sections.

12.4.1 Writer cannot re-direct the spooled file

If you submit a spooled file to a printer not supporting the data stream of the spooled file, processing stops, and the writer holds the spooled file. Figure 210 shows message CPI3379 returned when trying to print an AFPDS spooled file to a printer configured as *IPDS, AFP(*NO).

```
Message ID . . . . . : CPI3379      Severity . . . . . : 30
Message type . . . . . : Information
Date sent . . . . . : 11/16/97      Time sent . . . . . : 10:08:40

Message . . . . . : Writer PRT02 cannot re-direct file QSYSPRT to device
PRT02.
Cause . . . . . : Writer PRT02 could not re-direct file QSYSPRT number 2 job
026403/ITSCID17/QPADEV0010 to device PRT02. Advanced function printing data
stream (AFPDS) data cannot be converted to the format required to produce
the file on that device.
Recovery . . . . . : File QSYSPRT can only be produced on a printer supported
by advanced function printing (AFP). If device PRT02 can be started with the
AFP specified as *YES, stop the writer, change the device description for
the printer (CHGDEVPRT command) by specifying the AFP parameter as *YES, and
start the writer again.
```

Figure 210. Message CPI3379

Regarding the previous recovery information, note that to change the device description, you must first vary off the device. Therefore, the sequence is: end writer, vary off device, change device description, vary on, and finally start writer.

In the QSYSOPR message queue, this message is followed by message CPF3395 (spooled file held by writer). Depending on the spooled file data stream and the target printer, the error message returned can be CPI3370, CPI3372, CPI3373, CPI3376, or CPI3377.

12.4.2 Message PQT3630

Message PQT3630 is returned when an error occurs during the processing of an IPDS spooled file directed to a printer configured as *IPDS, AFP(*YES). The QSYSOPR message queue shows the sequence of messages presented in Figure 211.

```
Device NP17 returned negative acknowledgment with sense data.  
Data Check at printer NP17.  
Printing of file QSYSPRT by writer NP17 not complete.  
File QSYSPRT held by writer NP17 on output queue NP17 in QUSRSYS.
```

Figure 211. QSYSOPR message queue

The message CPF3395 “File QSYSPRT held by writer NP17 on output queue NP17 in QUSRSYS” gives information on the writer action. To see the cause of the error, the message PQT3630 “Device NP17 returned negative acknowledgment with sense data” must be analyzed.

Press F1 to display the additional message information shown in Figure 212.

```
Message ID . . . . . : PQT3630      Severity . . . . . : 10  
Message type . . . . . : Information  
Date sent . . . . . : 11/16/97     Time sent . . . . . : 10:33:14  
  
Message . . . . . : Device NP17 returned negative acknowledgment with sense  
data.  
Cause . . . . . : Sense data X'08C10100 DE010001 00000000 D62D0101 01010000  
00000001' was received from device NP17.  
Recovery . . . . . : See messages that follow for additional information about  
the error condition. The data stream manual for your printer contains more  
information about the sense data.  
Technical description . . . . . : The internal message identifier (ID)  
is CNACK101.
```

Figure 212. Message PQT3630

The sense data is the negative acknowledgement (NACK) returned by the printer to the writer (in this case, PSF/400). Six classes of data stream exceptions are returned by the printer. They are:

- Command reject
- Intervention required
- Equipment check
- Data check
- Specification check:
 - IO images
 - Barcodes
 - Graphics
 - General
- Conditions requiring host notification

In this example, the NACK returned is “08C1”, the first two bytes of the sense data. Refer to *IBM Intelligent Printer Data Stream Reference*, S544-3417, or to the IPDS manual of the printer for an explanation of the exception ID.

Table 23 shows an example of the exception ID from an IPDS reference manual.

Table 23. Data check exceptions

Exception ID	Description	Action code
X'0821.00'	Undefined character	01
X'0860.00'	Numeric representation precision check	01
X'08C1.00'	Position check	01

According to Table 23, exception “08C1” is a position check. This means you are trying to print outside the physical page. The cause is that the page size defined in the printer file is larger than the physical page size (paper), and the FIDELITY parameter is set to *ABSOLUTE in the printer file. This is discussed in the next section.

12.4.3 Fidelity parameter

The fidelity parameter in the printer file specifies whether printing continues when print errors are found for printers configured with AFP(*YES). Two values are possible for this parameter:

- *CONTENT** Printing continues when errors are found.
- *ABSOLUTE** Printing stops when errors are found.

If the fidelity is set to *ABSOLUTE and any AFP resources, such as fonts, overlays, or page segments referenced in the spooled file are not available, the spooled file is held by the writer.

The QSYSOPR message queue shows the sequence of messages presented in Figure 213.

```

.....
The resource object PS1 was not found for user USER01.
Spooled file QSYSPT did not print.
File QSYSPT held by writer NP17 on output queue NP17 in QUSRSYS.
.....

```

Figure 213. QSYSOPR message queue: Resource object not found

For the message PQT0012 “The resource object PS1 was not found for user USER01”, press F1 to display the additional message information. The possible causes for this problem include:

- AFP resources are not in the system.
- The library containing the resources is not in the library list.
- Fonts are not available or are not available in the printer resolution.

12.5 Copying spooled files

You can use the Copy Spooled File (CPYSPLF) command to copy a spooled file to a physical file. But, if the spooled file is *USERASCII, *AFPDS, *LINE, or *AFPDSL (determined by the DEVTYPE parameter on the printer file), you cannot copy the spooled file. If the spooled file is *IPDS, you can copy it, but the data stream cannot contain any special device requirements such as fonts, barcodes, or rotated text.

One other possibility is to use the Get Spooled File (QSPGETSP) API to get the data from an existing spooled file. Data is retrieved from the existing spooled file by a buffer (one or more) and is stored in a user space. For detailed information on the QSPGETSP API and other spooled file APIs, see *AS/400 System API Reference*, SC41-5801.

The third possibility is to use the QSPGETF system program. To place the copied spooled file back into an output queue, you can use the QSPPUTF system program. Authority to these system programs is *PUBLIC *EXCLUDE.

- System program QSPGETF has the following five parameters. All character parameters must be entered in uppercase and be enclosed in quotation marks. The database file and member are created if they do not exist prior to the call.
 - 1- 10** Character spooled file name.
 - 2- 20** Character qualified database file name in which to dump the spooled file. The first 10 characters contain the database file name. The second 10 characters contain the database file library name.
 - 3- 26** Character qualified job name of the job that created the spooled file. The first 10 characters contain the job name. The second 10 characters contain the job user. The last six characters contain the job number.
 - 4-** Numeric spooled file number 1 through 9999. If using the call interface, specify the spooled file number as a hex value as: X'0001' to X'270F' for spooled file numbers of 1 through 9999.
 - 5- 10** Character database file member name in which to dump the spooled file.

The following example dumped spooled file, QPRINT, to database file, SPOOLDB, and member, MBR1. The spooled file number was 1. You can enter the information on the command line or prompt on the call command to enter the parameters.

```
CALL PGM(QSYS/QSPGETF) PARM('QPRINT ' 'SPOOLDB USER1LIB '  
 'DSP03 USER1 010160' X'0001' 'MBR1 ')
```

- System program QSPPUTF has the following three parameters. All character parameters must be entered in uppercase and be enclosed in quotation marks.
 - 1- 20** Character qualified database file name from which to re-spool the spooled file. The first 10 characters contain the database file name. The second 10 characters contain the database file library name.
 - 2- 20** Character qualified output queue name to which to re-spool the spooled file. The first 10 characters contain the output queue name. The second 10 characters contain the output queue library name.
 - 3- 10** Character database file member name to which to re-spool the spooled file.

The following example re-spooled a previously dumped spooled file from database file SPOOLDB and member MBR1 to output queue USER1. You can enter the information on the command line or prompt on the call command to enter the parameters.

```
CALL PGM(QSYS/QSPPUTF) PARM('SPOOLDB USERLIB '  
    'USER1 QGPL ' 'MBR1 ')
```

12.6 Problem with output presentation

Many presentation problems are related to the position of the data on the page, the printer's unprintable border, or to the page rotation parameter in the printer file.

12.6.1 Physical page: Logical page

The physical page is the format of the paper loaded in the printer. The logical page size is from the printer file page size parameter.

12.6.1.1 Physical page size same as logical page size

In the example shown in Figure 214, the physical page size is the same as the logical page size.

- With a rotation of 0 degrees, all the physical, logical, overlay, and data origins are at the top left corner of the paper.
- With a rotation of 90 degrees, the logical page and the overlay are positioned from the physical page origin at the bottom left corner of the paper. Data positioning is from the top left corner of the logical page.

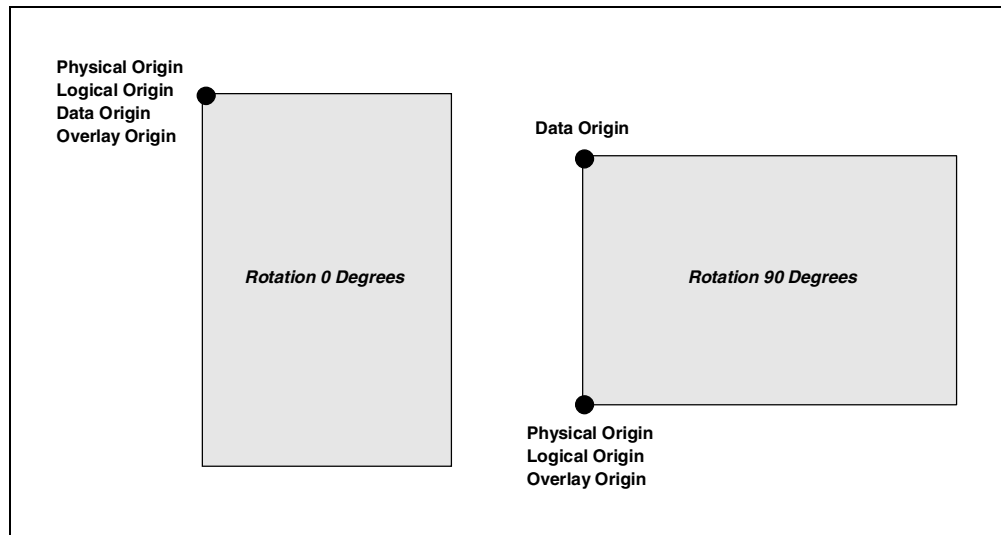

Figure 214. Physical page same as logical page

Note: We recommend that you set the physical page size equal to the logical page size to avoid data position problems.

12.6.1.2 Logical page smaller than physical page

In the example shown in Figure 215 on page 272, the logical page size is smaller than the physical page size.

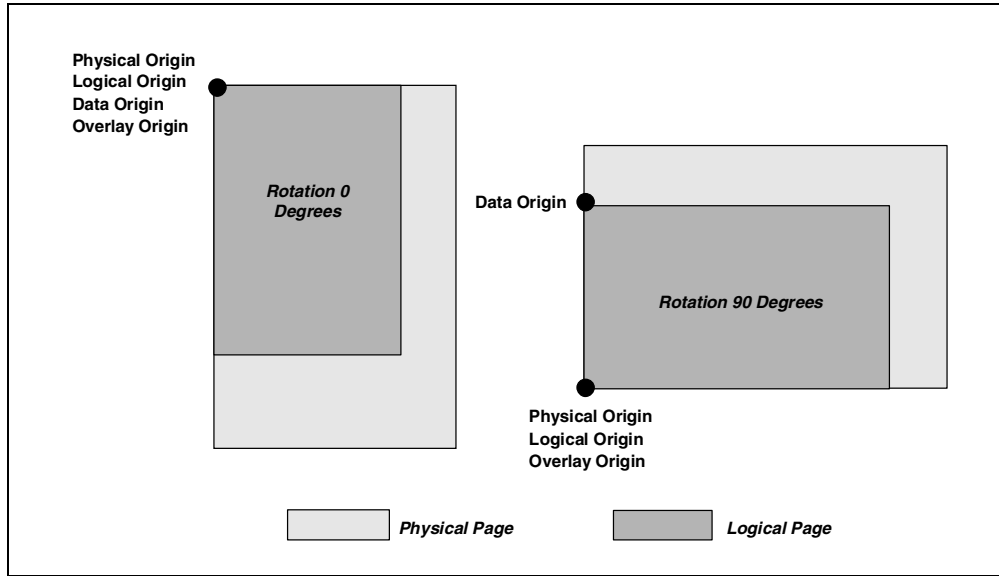

Figure 215. Logical page smaller than physical page

With a rotation of 0 degrees, all the physical, logical, overlay, and data origins are at the top left corner of the paper. The data is properly positioned.

With a rotation of 90 degrees, the logical page and the overlay are positioned from the physical page origin at the bottom left corner of the paper. Data positioning is from the top left corner of the logical page. You will encounter a data position problem.

12.6.1.3 Logical page larger than physical page

In the example shown in Figure 216, the logical page size is larger than the physical page size.

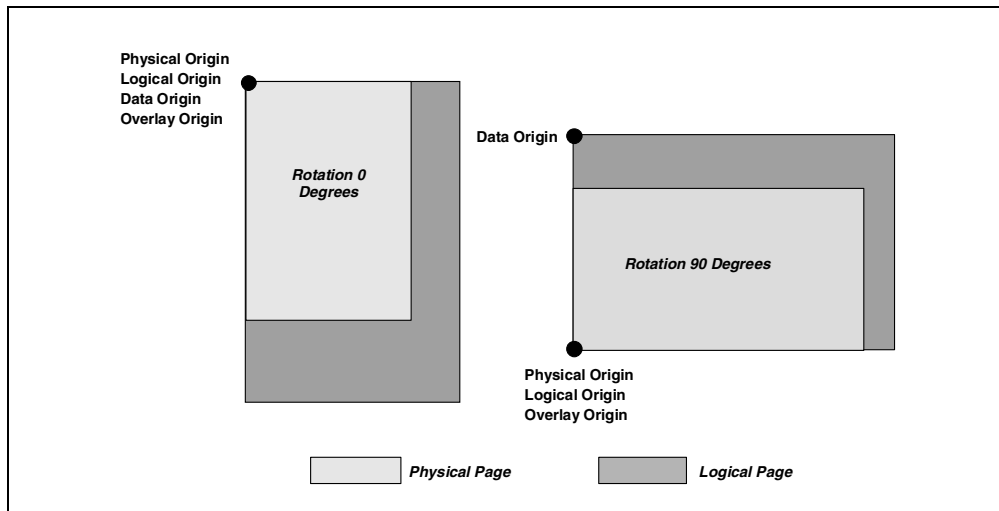

Figure 216. Logical page larger than physical page

With a rotation of 0 degrees, all the physical, logical, overlay, and data origin are on the top left corner of the paper. The data is properly positioned.

With a rotation of 90 degrees, the logical page and the overlay are positioned from the physical page origin on bottom left corner of the paper. Data positioning is from the top left corner of the logical page. You will encounter a data position problem, as the top lines of the print output are outside the physical page. You may lose part of your print output.

12.6.2 Printer setup

Some printers have an unprintable border and the logical page is positioned at the edge of the printable area instead of the edge of the physical page (Figure 217).

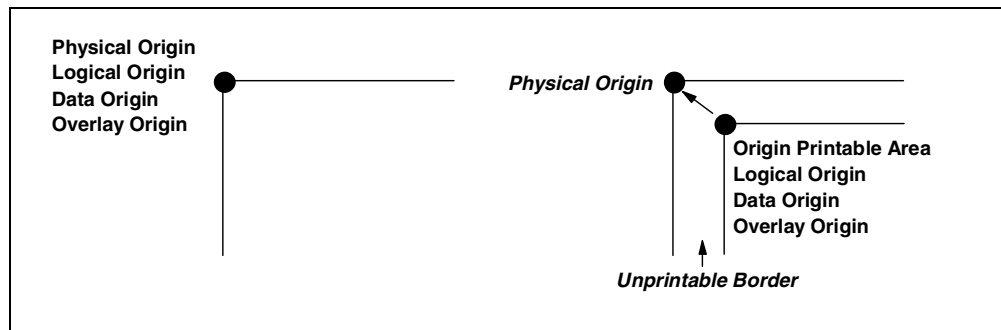

Figure 217. Unprintable border

Printer setup parameters, such as Page=Print, Edge-to-Edge, VPA Check, and the QPRTVALS data area, allow you to move the origin from the edge of the printable area to the edge of the physical page, or to control its effect.

Note: If you have printers without an unprintable border and printers with an unprintable border, having the origin at the same place ensures the same presentation on both types of printer.

For detailed information, see Chapter 10, “IBM AS/400 network printers” on page 205, *AS/400 Printing III*, GG24-4028, and *AS/400 Printing IV*, GG24-4389, for various models of printers.

12.6.3 Computer Output Reduction

If you specify a page rotation of *AUTO or *COR in the printer file, and your data cannot fit on the page because your logical page is larger than the physical page, the Computer Output Reduction (COR) function is used (Figure 218 on page 274). *COR always uses CORing, regardless of page size (unlike *AUTO).

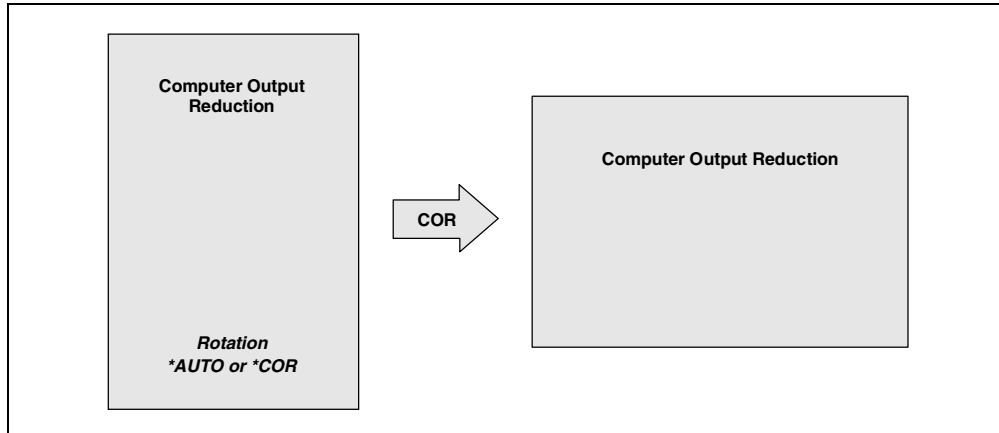

Figure 218. Computer Output Reduction

The COR function rotates your page 90 degrees and prints your data with a smaller font. For example, a 15 cpi or 17.1 cpi is used.

Note: To avoid non-desired COR, selected a rotation value of 0, 90, 180, or 270 degrees in the printer file.

12.6.4 A3 page support

Before A3 paper became a commonly-supported page size, PSF/400 was limited to a maximum page size of 11.3 inches for the short side and 14 inches for the long side of the logical page. The effect of this was that output was truncated with a printer file specifying a page size of over 140 characters at 10 cpi, 168 characters at 12 cpi, 210 characters at 15 cpi, and so on.

A PTF is now available to allow larger page sizes for printers that support A3 paper size. It is only effective for printers configured as *IPDS, AFP=*YES.

Note: *IPDS, AFP=NO printers do not have this problem because they take the logical page size from the printer file in this case.

The APAR number for Version 3.0 Release 7.0 and V4R1 is SA64384. PTF numbers are SF44581 and SF44098, respectively. At the time this redbook was written, support had not been added for earlier releases of OS/400.

12.7 Font problems

Many messages are related to fonts, and most simply report that a font substitution was performed (for example, the message PQT2072). See Figure 219.

```
Message ID . . . . . : PQT2072
Message file . . . . . : QPQMSGF
Library . . . . . : QSYS

Message . . . . . : Font substitution was performed.
Cause . . . . . : Your print request for file &1 number &2 in job &5/&4/&3
referred to resident character set (FGID) 10 and resident code page 0037.
These resident resources are not present in printer PRT01. A font
substitution was performed that keeps as many characteristics as
possible of the originally requested font. Resident character set (FGID)
11 and resident code page 0037 were substituted. A value of *DFLT for
the substituted character set (FGID) or code page means that the printer
default was used. If you specified absolute fidelity, processing of the print
request ended. If you specified content fidelity, the substitution was
performed, and processing of the print request continued.
```

Figure 219. Font substitution message PQT2072

You can also receive other font substitution messages, such as:

- PQT2066** Font substitution was performed. Your print request referred to a resident font, and resident fonts are not supported by this printer.
- PQT3531** Font substitution was performed. Your print request referred to a character set, and this printer only supports resident fonts.
- PQT3533** Font substitution was performed. Your print request referred to a character set with an incompatible resolution to the printer.
- PQT3535** Font substitution was performed. Your print request referred to a character set and code page. The code page could not be found.
- PQT3537** Font substitution was performed. Your print request referred to a character set and code page. You are not authorized to use the character set.
- PQT3539** Font substitution was performed. Your print request referred a character set and code page. You are not authorized to use the code page.
- PQT3541** Font substitution was performed. Your print request referred to a raster character set, and you requested that outline fonts be used when possible.
- PQT3542** Font substitution was performed. Your print request referred to a character set and code page. The device does not support outline fonts.
- PQT3543** Font substitution was performed. Your print request referred to character set at one resolution, and a character set with this resolution cannot be found.
- PQT3544** Font substitution was performed. Your print request referred to an outline font, but outline fonts are not supported by the printer.

On each message, there is useful information about the font resources with the problem.

Note: In Version 4.0 Release 2.0 and later, a parameter in the PSF configuration object allows you to suppress logging the font substitution messages.

For more information on fonts, font tables customization, outline fonts, and font substitutions, see Chapter 4, “Fonts” on page 89.

12.7.1 Problems with shading at different resolutions

If you create an overlay with AFP Utilities/400, AFP Driver, or other tools, you have the option to shade inside a box. The shaded element that is created is often a raster pattern that depends on the pel density of the printer to which it is going. If the density does not match, you may notice some or all of these symptoms:

- You receive message PQT3513 that states “The resolution of an image does not match the resolution of the printer”. If the printer file is set to *Absolute fidelity, the file is held. If the fidelity is set to *Content, the page will print, but the shading may be distorted.
- The distortion is most apparent if you have shading that was generated for a 300-pel printer but is printed on a 240-pel printer. There is a noticeable “waffle” pattern in the output. If you have shading that was generated for a 240-pel printer printing at 300-pel, the texture might change somewhat, but it is not as bad.
- There may be performance degradation. If you are on V3R1, check for PTF SF44977. This fix was included in all other current releases.

Possible solutions are:

- With V3R7 or later, you can use the PSF configuration object to specify the Device Resource Library List. That way you can create two versions of the overlay, one for each density, and have them in different libraries. Then you list the appropriate library in each printer's DEVRSCLIBL parameter.
- If you are on an earlier release and need to print on printers at different densities, we recommend that you create the resource at 240-pel to print on the 300-pel printers. This avoids the waffle effect.

12.8 Drawer and paper path selection problems

To use the drawer selection for a printer, the FORMFEED parameter must be set to *AUTOCUT. If this is not done, the DRAWER parameter is ignored (because, for example, PSF/400 believes it is using a printer with continuous forms). The FORMFEED parameter is in the printer file and also in the printer device description (the parameter in the printer file may default to *DEVDD).

Note: The Facsimile Support/400 product uses the drawer number to specify the format of the facsimile (for example, drawer 1=letter, and drawer 3=A4). In this case, the FORMFEED parameter must also be set to *AUTOCUT.

12.8.1 IBM 4247 paper path selection

The IBM 4247 printer can be configured in 4230/4224 emulation or in native mode. The paper path selection varies from one mode to the other.

12.8.1.1 4230/4214 emulation mode

For 4230/4214 emulation, only one attachment may be on the printer at a time.

If you want to use the automatic sheet feeder, it is best that you run in 4230/4214 emulation mode. For automatic sheet feeder, specify `FORMFEED (*AUTOCUT)`, `DRAWER (n)` on the printer file, where *n* is:

- 1 Drawer 1
- 2 Drawer 2
- 3 Drawer 3

For 4230/4214 continuous forms, specify `FORMFEED(*CONT)` on the printer file.

12.8.1.2 4247 native mode

For 4247 mode, multiple attachments may be on the printer at the same time. However, in this mode, the drawer selection number for the automatic sheet feeder has changed. Specify `FORMFEED (*AUTOCUT)`, `DRAWER (n)` on the printer file, where *n* is:

- 5 Drawer 1
- 6 Drawer 2
- 7 Drawer 3

For 4247 front continuous forms attachment, specify `FORMFEED (*CONT)` in the printer file.

For 4247 rear continuous forms attachment (Version 3.0 Release 1.0 and Version 3.0 Release 6.0), specify `FORMFEED (*AUTOCUT) DRAWER (2)` in the printer file.

For 4247 rear continuous forms attachment (Version 3.0 Release 2.0 and Version 3.0 Release 7.0 and later), specify `FORMFEED (*CONT2)` or `FORMFEED (*AUTOCUT) DRAWER (2)` in the printer file.

12.9 Printing on ASCII printers

The following considerations are for printing AS/400 spooled files to ASCII printers:

- Use the host print transform function in place of an emulator (PC or display). There are more printer functions, such as the AFPDS to ASCII transform, and the transform table can be customized. For detailed information on host print transform, see 1.3.3, "Host print transform" on page 13.
- In the host print transform table, select the emulation or driver according to your printer type and model.
- Check the printer setup (code page, paper format, timeout, and so on).
- Check that your printer file parameters reflect your ASCII printer capabilities (for example, page size (A3 supported?), duplexing (supported?), and available fonts).
- Refer to the ASCII printer technical manual for available fonts, size of the unprintable border, maximum lines per page, maximum characters per line, and so on.

12.10 Additional information

Because program temporary fixes (PTFs) might be superseded rapidly, check the PTF numbers provided in this document for their accuracy. The World Wide Web provides lists with recent PTF numbers and microcode levels for IBM printers. These lists can be found at: <http://www.printers.ibm.com/products.html>

Subsequent ones are, for example:

- **Hints and tips:**

Contains technical items or “flashes”.

- **Service planning:**

Contains the minimum and current microcode level of the IBM Network Printers.

- **Service notes:**

Gives a list with recommended OS/400 PTFs for printers configured with AFP functions.

Alternatively, your IBM representative should be able to provide a list of required PTFs.

Appendix A. PSF/400 performance factors

This appendix considers factors relating to printing performance on the AS/400 system, in *approximate* order of importance, starting with the most significant to the least significant. Which factors have the most affect on your system printing depends on your particular system and printer configuration, as well as the type of spooled files you are printing.

A.1 AS/400 system storage

The amount of system storage (memory) allocated to the *SPOOL pool is crucial for successful AFP printing. The minimum for AFP printing should be 2000 KB to 3000 KB (that is, 2 MB to 3 MB). For AFP printers operating simultaneously, consider allocating 500 KB to 1000 KB more for each additional printer. If you are using LPR/LPD printing (for example, with a remote output queue), start with at least 6 MB in *SPOOL.

You can check the storage allocated on the Work with System Status (WRKSYSSTS) display. To identify the *SPOOL pool, press F11 twice to produce the Work with System Status display shown in Figure 220 on page 280.

In this example, the setting of the QPFRADJ (Performance Adjustment) system value has automatically allocated storage across the storage pools. The system value controls whether automatic balancing of memory is done and when it is done (at IPL, during normal operations, or both).

If you do not use automatic adjustment, you can monitor the *SPOOL pool for excessive page faulting, and even change the pool size “in flight”, although you are only taking it from another pool that may have a greater requirement (for example, a batch or interactive job).

Be aware that the automatic adjustment may be too slow in responding to use the printing subsystem, especially for smaller jobs. On systems running Version 4.0 Release 1.0 or later, you can use the Work with Shared Pools (WRKSHRPOOL) command to assign minimum and maximum percentage values for *SPOOL (use the F11 key marked (Display tuning data)). If auto-tuning is set on through QPFRADJ, these limits may be adjusted automatically. The default minimum percentage is 1% of the total main storage. In the example shown in Figure 221 on page 281, the total system storage is 4718592 KB, and the minimum percentage size for *SPOOL has been set at 10%.

```

Work with System Status
LUCYHH05
12/01/97 16:25:34
% CPU used . . . . . : 2.8 Auxiliary storage:
Elapsed time . . . . . : 00:00:01 System ASP . . . . . : 67.71 G
Jobs in system . . . . . : 19243 % system ASP used . . . : 35.1832
% addresses used: Total . . . . . : 67.71 G
Permanent . . . . . : .007 Current unprotect used : 467 M
Temporary . . . . . : .010 Maximum unprotect . . . : 487 M

Type changes (if allowed), press Enter.

System Pool Reserved Max
Pool Size (K) Size (K) Active Pool Subsystem Library
1 415780 244856 +++++ *MACHINE
2 3545416 0 204 *BASE
3 47184 0 4 *SPOOL
4 710212 0 87 *INTERACT

Command Bottom
====>
F3=Exit F4=Prompt F5=Refresh F9=Retrieve F10=Restart
F11=Display paging option F12=Cancel F24=More keys

```

Figure 220. Work with System Status: Displaying pool names

A.2 Data stream type

By default, AS/400 printer files use SNA Character String (SCS) as the data stream type. This type of data stream can be sent to any printer, including ASCII printers using the SCS-to-ASCII host print transform. SCS spooled files can also be sent to printers configured as *IPDS, AFP=NO, and *IPDS, AFP=*YES. The print writer handles this automatically. It looks at the printer's device description and transforms the SCS spooled file into the appropriate data stream. For IPDS printers configured AFP(*YES), the standard process includes the following steps:

1. An SCS spooled file sent to an IPDS printer is:
 - a. Converted to generic IPDS.

Note

This is explained in 1.3, "Printer writer" on page 6.

- b. Converted to AFPDS.
 - c. Converted into printer-specific IPDS.

The converted spooled file is then sent to the printer.
2. An IPDS spooled file is:
 - a. Converted to AFPDS.
 - b. Converted into printer-specific IPDS.

The converted spooled file is then sent to the printer.
3. An AFPDS spooled file is converted directly into printer-specific IPDS format.

The converted spooled file is then sent to the printer.

The conversion for SCS and IPDS are there to ensure complete fidelity of the result. For example, this ensures that if a front overlay was specified in the printer file of an SCS spooled file, the overlay comes across in the conversion. Obviously, there is time and system processor cycles involved in the SCS and IPDS conversions. With Version 3.0, a new customizing option (called IPDS Pass Through) enables control over SCS and IPDS conversions to reduce the conversion time. See A.2.1, "IPDS pass through" on page 282, for more information.

These conversions are illustrated in Figure 221. Notice how the size of the shaded box decreases depending on the data stream type specified. This represents the reduced work the AS/400 processor has to perform.

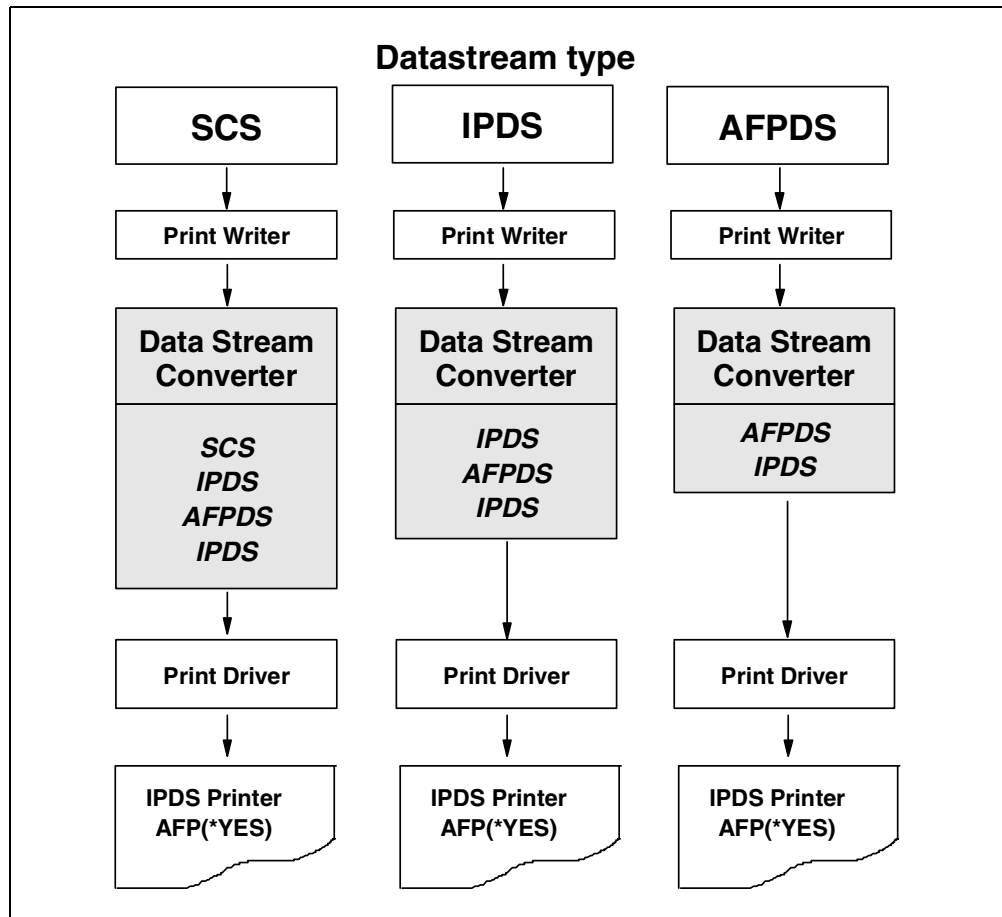

Figure 221. Data stream transforms when printing to an IPDS AFP(*YES) printer

Generally speaking, if your output is to contain AFP resources, such as overlays, page segments, and host font character sets, specify *AFPDS in the printer file. You frequently need to do this, in any case, to obtain support for certain DDS keywords.

If you are printing to a printer configured as *IPDS, AFP=NO, code the data stream type as *IPDS (for example, an IPDS impact printer). This data stream has several restrictions (these restrictions are discussed in 1.3, "Printer writer" on page 6).

Leave the data stream type as *SCS if your output is straightforward (reports, listings, for example) and can be printed on any of the printers in your organization.

A.2.1 IPDS pass through

This parameter is available on the WRKAFFP2 (V3R1/V3R6) and WRKPSFCFG (V3R2/V3R7 and later) commands described in Chapter 11, “Configuring LAN-attached printers” on page 223. It cuts down on some of the internal transforms described previously (for example, an SCS spooled file is converted directly to printer-specific IPDS, and an IPDS spooled file does not require any conversion).

There are some restrictions as to its use such as spooled files with overlays, image data, or software multi-up. However, in these cases, the normal transforms will occur. Therefore, for a printer configured as *IPDS, AFP=*YES, set the IPDSPASTHR parameter to *YES.

A.2.2 Printer device description parameters

These settings are related to the data stream conversion carried out by the AS/400 processor. They obviously apply only to individual printers.

- **Print while converting:** This should be set to *YES so that pages in a large spooled file may start to print before the entire process of conversion has completed. You may also want to adjust the priority of the writer job, for example, by using:

```
WRKACTJOB SBS(QSPL)
```

Then, change the job priority for the WTR job for your printer in the range 0 (highest priority) through to 9 (lowest priority). This allows you some control over the conversion process.

- **Maximum pending requests:** This refers to the number of spooled files that may be converted by the AS/400 processor for each printer at any one time. The default value is 6. If you are regularly printing many small (one page to five page) spooled files to a fast printer (20 ipm to 30 ipm), you may want to increase this value. If you are printing larger spooled files (300 pages and more), you may want to decrease this value slightly. The main effect is on disk usage.

A.3 AFP resource retention

Since Version 3.0 Release 1.0, PSF/400 automatically stores downloaded AFP resources in an IPDS printer across job boundaries subject to memory constraints. This is on the likely chance that the succeeding job can also reference one or more of the previous job's AFP resources. This cuts down on resource download time and, therefore, the overall throughput of the job. Note that this is possible because the AFP print job contains only references to the AFP resources. These may or may not actually be present in the data stream.

Resource retention may be switched off if required, using the RSCRET parameter in the WRKPSFCFG command or the DRR parameter in the WRKAFFP2 command. The default in each case is for resource retention to be enabled.

A.3.1 Clear memory for security

Some AFP printers, including the AFCCU printers, have a similar hardware feature called “Clear Memory for Security”. This flushes the printer memory between each print job and, therefore, should be set to *NO. IBM AFCCU printers are shipped with this feature enabled, so it is worth checking the printer operator panels to ensure it is disabled.

A.4 Font types

Typically, when a font is downloaded to a printer, it is a raster (bitmapped) image containing the entire character set. Outline (scalable) fonts contain only the vector instructions for drawing the selected characters. Therefore, using outline fonts reduces the download time considerably. This is more noticeable when printing large characters because the printer's control unit scales the outline font to the requested point size. Techniques for working with font performance are described in the following sections:

- Section 4.5.1, “Downloading host-resident outline fonts” on page 100
- Section 4.5.2, “Why use an outline font” on page 100
- Section 4.10, “Font capturing” on page 108
- Section 5.5, “Text versus image” on page 129

At the present time, downloading outline fonts is only possible with IBM AFCCU printers.

A.4.1 Using GDDM fonts

Strictly speaking, these are not fonts, but graphical symbol sets (object type *GSS) found in the QGDDM library shipped with the OS/400 operating system. They are used in a similar manner, for example, using the FONT keyword and specifying a graphical symbol set such as ADMWMOB (Multi-National Open Block). The results are smooth, rounded characters scaled to the size specified with the CHRISZ keyword. They are referenced by the name of the graphical symbol set (for example, in Figure 222).

```
0030      A          R TXT1
0031      A          LIN01          1A
0032      A                                FONT(ADMWMOB)
0033      A                                CHRISZ(2.0 3.0)
```

Figure 222. DDS record format specifying a GDDM font

The penalty is that they take longer to produce and print than raster or printer-resident scalable fonts. This is particularly noticeable on IPDS impact printers where text appearance is lower in priority in any case. Shipping documentation is a typical example. Fast printer throughput is usually the aim as long as the enlarged output is readable.

There is significantly faster performance if you use an outline font and then scale it to the required size using a point size (for example, using Helvetica Bold). See Figure 223 on page 284.

0030	A	R	TXT1		
0031	A		LIN01	1A	
0032	A				FONT(2305 (*POINTSIZ 30))

Figure 223. DDS record format using a printer-resident outline font

On a printer that does not have outline fonts (such as an IPDS impact printer), specify a resident font, but use the CHRSIZ keyword to scale it. The quality of the character shape is not as good. The appearance is “blocky”, but printing is faster than if using a GDDM font. CHRSIZ is not supported on the AFCCU printers, but these have outline fonts in any case.

A.5 Library list searches

You can help PSF/400 locate AFP resources quickly by placing AFP resources in user library lists (USRRSCLIBL) and device resource library lists (DEVRSCLIBL). The two parameters refer to those in the PSF configuration objects associated with printer device descriptions.

An example of an AFP resource placed in a user resource library might be a user's signature stored as a page segment called USERSIG. Therefore, the printer file can reference the page segment by this name. Which signature is printed depends on the user submitting the job. An example of using the device resource library might be to store different versions of the same overlay by device resolution (240 or 300 dpi). Which overlay is used depends on the printer to which the job is sent.

Generally speaking, the higher in the library list an AFP resource appears, the better. In addition, explicitly specify a resource where possible (for example, MYLIB/INVOICE to specify an AFP overlay), rather than *LIBL/INVOICE.

A.6 Creating efficient AFP resources

Some tools are more efficient than others at producing AFP resources. As an unscientific rule of thumb, the easier and more user-friendly the tool is, the less-efficient the resource is! AFP Utilities/400 is native to the AS/400 system, offers a near-WYSIWYG approach to designing overlays, and produces relatively efficient AFP resources in terms of file size and speed of printing. The AFP driver allows you to produce overlays using sophisticated PC functions, but if the driver is set up to produce a resource entirely composed of image data, the download and print speed is noticeably reduced. The answer is to create such an overlay using text components wherever possible (see 5.5, “Text versus image” on page 129).

General principles for such tools are that rounded elements, such as curves and rounded boxes, take longer to produce than square elements, and dotted or dashed lines take longer to print than solid lines. The reason for this is that straight lines may often be produced using text IPDS commands, instead of image commands.

Excessive use of shading may also slow downloading and printing an AFP resource. Obviously, the design should take precedence, and simple experiments

may show that the shading or particular design is not having any noticeable effect on performance.

A.7 Other factors

These may or may not be of significance, depending on your particular printing configuration.

A.7.1 PSF configuration object parameters

These parameters apply to any printer that references the PSFCFG object in its device description.

The ACKFRQ (Acknowledgement Frequency) parameter in the PSFCFG object is new with Version 4.0 Release 2.0. It specifies the frequency, in pages, with which PSF/400 sends IPDS acknowledgement requests to the printer. In return, the printer responds with information about the status of the print job (how many pages have been printed, for example).

The parameter can be used with the AUTOSSNRCY (Automatic Session Recovery) parameter, also new with Version 4.0 Release 2.0. If a problem causes a print session to be disconnected and then re-established, PSF/400 may send duplicate pages to be reprinted because it did not have the current status of the printer. By increasing the ACKFRQ parameter, you can reduce the number of reprinted pages. However, too many acknowledgements slow down the communication between PSF/400 and the printer.

This parameter should relate to the speed of the printer. If we imagine a printer rated at 100 ipm (impressions per minute), the default ACKFRQ setting of 100 pages will cause an acknowledgement to be transmitted every minute. You can, therefore, increase this parameter for faster printers and reduce it for slow desktop printers. If the number of pages in the job is less than the ACKFRQ value, an acknowledgement is sent at the end of the job in any case. But be aware of the increased likelihood of duplicate pages should the session to a printer with a high acknowledgement interval end abnormally.

A.7.2 Printer file parameters

These parameters require a change to the printer file used by your application.

Unless you have special requirements, set the Spooled Output Schedule printer file parameter to *IMMED rather than *FILEEND so spooled file processing may begin without waiting for the producing job to complete (it may be closing files or performing other non-printing tasks).

A.7.3 Printer settings

These changes are made at the printer operator panel.

- **MTU Sizes:** Many printers have an optimum Maximum Transmission Unit (MTU) size. The MTU is the maximum allowable length of data packets in bytes. This is usually documented in the setup guide for the printer. For example, the recommended size for an AFCCU printer using TCP/IP is 4096. This value should match the MTU size of other devices on the LAN. For an SNA-attached printer, the printer MTU should not exceed the value specified

in Maximum Frame Size in the APPC Controller description. In turn, this value should be equal to or less than the equivalent value in the Token-Ring line description. A common value for the SNA Token-Ring is 4060.

- **Printer Memory:** Printers with particular requirements include those that support multiple data streams. Memory may be used to swap out resources and print commands while those of another data stream are loaded.

For IPDS printing on the IBM Network Printer range, best performance with current microcode levels is seen with 16 MB to 20 MB memory, depending on the complexity of the output. PCL memory requirements for these printers, whether it be from the AS/400 system or a PC client, depends on additional factors such as the page size used and duplexing. These requirements are documented in the *User's Guide* for each model. For the IBM 3130, we recommend that you use at least 16 MB of extra memory for each additional data stream (PCL or PostScript) that is used. Extra memory may also benefit the throughput of IPDS-only jobs.

- **Early Print Complete:** This option, or similar, is available on some twinaxially-attached IPDS printers including the IBM network printers. If enabled, the printer sends back a good acknowledgement to PSF/400 when it has received the data rather than when it has printed it. This improves performance at the risk of losing data (for example, through a paper jam). If you enable this feature, set the PRTERMSG parameter in the device description to *INFO to ensure you are made aware of any conditions or interventions at the printer.

We do not recommend that you enable this feature unless you always save copies of your spooled files. One of the keystones of the IPDS architecture is the two-way dialogue between host and printer and the improved error recovery it provides. You may find that third-party implementations of IPDS are, in fact, using a similar feature to Early Print Complete (that is, they send a good acknowledgement back to the host immediately on receiving the data).

- **IPDS Buffer Size:** Also found only on twinaxially-attached printers, this should be set to 1024 bytes rather than 256.

Appendix B. Data Description Specifications (DDS) formatting

DDS formatting within the printer file is the standard OS/400 interface to printed output in the same manner that DDS is the interface for external database files. DDS can be used for SCS, IPDS, and AFP output. With host print transform, this can be extended to ASCII formats). Printer file DDS contains support for all the elements in a standard document including overlays, images, graphics, barcoding, lines, boxes, and fonts. Printer file DDS is covered in detail in *OS/400 Printer Device Programming V4R2*, SC41-5713. This appendix provides a couple of examples to illustrate how documents can be formatted with DDS.

The quality of the illustrations in this appendix is not representative of the high quality output that can be produced on the AS/400 system, but is a function of the processes used to produce this publication.

B.1 DDS functionality example

Figure 224 on page 288 shows a sample application that provides a comprehensive example of DDS output formatting.

The DDS source used for this sample application is shown in Figure 225 on page 289 and Figure 226 on page 290.

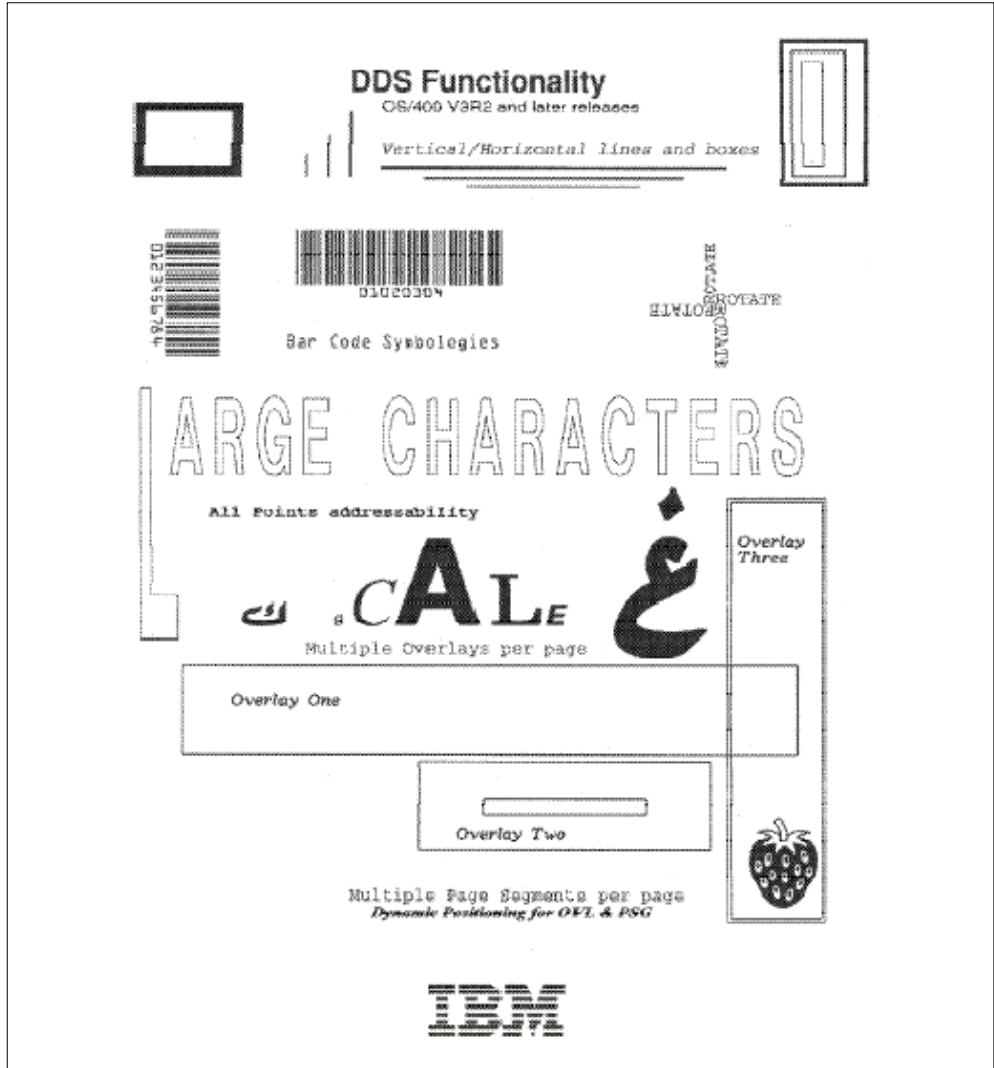

Figure 224. DDS functionality example

```

A* DDS Functionality Printer File Specifications (1 of 2)
A*
A      R HEADR1
A
A          PAGRIT(0)
A          DRAWER(1)
A* Print "DDS Functionality" in Helvetica Bold 20-point outline font
A      LIN01      35A
A
A          FNTCHRSET(CZH400 +
A          (*POINTSIZ 20) T1V10037)
A          POSITION(0.7 3.0) COLOR(RED)
A* Print "OS/400 V3R1 . . ." in Helvetica 12-point bitmapped font
A* w/dynamic positioning
A      LIN02      35A
A
A          FNTCHRSET(COH200B0 T1V10037)
A          POSITION(&VALDWN &VALACR)
A          COLOR(PNK)
A          VALDWN      5S 3P
A          VALACR      5S 3P
A* Print variety of lines w/ fixed attributes
A      R LINE1
A
A          LINE(1.3 2.6 0.2 *VRT *NARROW)
A          LINE(1.1 2.8 0.4 *VRT *MEDIUM)
A          LINE(0.9 3.0 0.6 *VRT *WIDE)
A* Print dynamic lines (position and attributes from program)
A      R LINE2
A
A          LINE(&LD &LA &LL *HRZ &LW)
A          LD          5S 3P
A          LA          5S 3P
A          LL          5S 3P
A          LW          5S 3P
A* Print fixed box
A      R BOX1
A
A          BOX(0.8 1.0 1.5 2.0 .1)
A* Print dynamic box (position and box attributes)
A      R BOX2
A
A          BOX(&BULD &BULA &BLRD &BLRA &BWITH)
A          BULD        5S 3P
A          BULA        5S 3P
A          BLRD        5S 3P
A          BLRA        5S 3P
A          BWITH       5S 3P
A* Print LIN08 - "Multiple Overlays per page" in default font
A* Print LIN09 - "Multiple Page Segments per page" in default font
A* Print "Dynamic Positioning" in printer-resident font 2311
A      R TXT0
A      LIN08      35A      36 27
A      LIN09      35A      50 31
A          51 33 'Dynamic Positioning for OVL & PSG'
A          FONT(2311 (*POINTSIZ 12))
A* Print LIN03 - "Vertical/Horizontal" in printer-resident font 18
A* Print LIN05 - "L" in GDDM scalable font
A* Print LIN06 - "LARGE CHARACTERS" in GDDM scalable font
A* Print LIN07 - "Add Points Addressability" in font 46 (Courier)
A      R TXT1
A      LIN03      35A          POSITION(1.3 3.3)
A          FONT(18) COLOR(BRN)
A      LIN04      35A          COLOR(YLW) FONT(19)
A          POSITION(3.1 2.4)
A      LIN05      1A          FONT(ADMMMOB)
A          POSITION(2.9 1.0)
A          CHRISZ(9.0 20.0)
A      LIN06      15A         FONT(ADMMMOB)
A          POSITION(3.4 1.3)
A          CHRISZ(6.0 6.0)
A      LIN07      35A          FONT(46)
A          POSITION(4.7 1.7)

```

Figure 225. DDS source for DDS functionality example (Part 1 of 2)

```

A* DDS Functionality Printer File Specifications (2 of 2)
A*
A*
A*
A* Print "Rotate" in four orientations
A      R TXT2
A          TXT1@1      6          COLOR (TRQ)
A                                  POSITION (2.7 6.4)
A          TXT1@2      6          TXTRIT (90) COLOR (RED)
A                                  POSITION (2.7 6.4)
A          TXT1@3      6          TXTRIT (180) COLOR (BLU)
A                                  POSITION (2.7 6.4)
A          TXT1@4      6          TXTRIT (270) COLOR (GRN)
A                                  POSITION (2.7 6.4)
A* Print Interleaved 2 of 5 bar code vertically
A* Print Code 3 of 9 bar code horizontally
A      R BAR1
A          BAR1@1      8S          BARCODE (INTERL2OF5 3 *VRT)
A                                  POSITION (2.0 1.8)
A          BAR2@1      8          BARCODE (CODE3OF9 3)
A                                  POSITION (2.0 2.5)
A* Print text in outline (or scalable) fonts
A      R FNT1
A          CHR1          1          POSITION (5.7 2.0) COLOR (RED)
A                                  FONT (2305 (*POINTSIZ 30)) CHRID
A          LTR1          1          POSITION (5.7 2.85) COLOR (RED)
A                                  FONT ( 420 (*POINTSIZ 13))
A          LTR2          1          POSITION (5.7 3.0) COLOR (BLU)
A                                  FONT (2310 (*POINTSIZ 45))
A          LTR3          1          POSITION (5.7 3.4) COLOR (PNK)
A                                  FONT (2305 (*POINTSIZ 80))
A          LTR4          1          POSITION (5.7 4.3) COLOR (GRN)
A                                  FONT (20224 (*POINTSIZ 55))
A          LTR5          1          POSITION (5.7 4.8)
A                                  FONT (2307 (*POINTSIZ 20))
A          CHR2          1          POSITION (5.35 5.45) COLOR (RED)
A                                  FONT (2305 (*POINTSIZ 110)) CHRID
A* Print images (page segments) w/ variable names and positioning
A      R PSG1
A                                  PAGSEG (&PSGNAM &PSGDWN &PSGACR)
A          PSGNAM          8A P
A          PSGDWN          5S 3P
A          PSGACR          5S 3P
A* Print Overlays One-Two-Three in fixed and dynamic form
A      R OVL1
A                                  ENDPAGE
A                                  OVERLAY (*LIBL/DDS OVL1 6.0 1.3)
A                                  OVERLAY (&OVLNM2 6.9 2.5)
A                                  OVERLAY (DDS OVL3 &OV3DWN &OV3ACR)
A                                  PAGSEG (BUSPART 7.20 1.9)
A          OVLNM2          8A P
A          OV3DWN          5S 3P
A          OV3ACR          5S 3P

```

Figure 226. DDS source for DDS functionality example (Part 2 of 2)

Looking at both the printed sample of “DDS Functionality” and the DDS source, let’s review the specifications in detail:

- **DDS Functionality (LIN01):** Printed in a 20-point Helvetica Roman-Bold font 0.7 inches down and 3.0 inches across. The FRONTMGN parameter of the printer file is set at 0 so the down/across positions are from the top/left edge of the page.

Note: The POSITION keyword specifies the baseline or bottom left point of the first character to print.

The font is specified using FNTCHRSET, which defines the character set and code page to use. In the C0H400J0 font character set resource, “C0” means it is a character set, “H400” means Helvetica Roman-Bold, and “J” means 20-point. This is a typographic font, part of the AFP Font Collection. For 300-pel printers, C0H400J0 is normally found in library QFNT300LA1. Code

page T1V10037 is the USA/Canada code page and is normally located in library QFNTCPL.

- **OS/400 V3R2 and Later Releases (LIN02):** Prints field in Helvetica Roman-Medium 12-point 0.9 inches down and 3.3 inches across. The FNTCHRSET value is CZH200, which is an example of the new (V4R2) outline font support. An outline font is one vector-based object that can be scaled to any desired point size. A new parameter (POINTSIZ) supplies the 12-point sizing for this text. Dynamic positioning is used, where the program variables LINDWN and LINACR are loaded with the down/across values and referenced in the DDS as program-to-system fields.
- **Vertical/Horizontal lines and boxes (LIN03):** Prints in Courier Italic starting 1.3 inches down and 3.3 inches across. The keyword FONT(18) specifies printer-resident Courier Italic.
- **Bar Code Symbologies (LIN04):** Prints in printer-resident font 19, which is OCR-A.
- **Large Characters (LIN05):** The “L” is printed in the Open Block font scaled by the CHRISZ keyword to 9.0 width and 20.0 height. ADMWMOB is the Open Block font, one of the GDDM scalable fonts, and is located in the QGDDM library. The balance of the text also prints in Open Block, but is scaled to 6.0 wide and 6.0 high.
- **All Points Addressability:** Prints in printer-resident Courier Bold, which is FONT(46).
- **Multiple Overlays per Page (LIN08):** Prints in the printer-resident Courier (font 11), which is the default font. In this case, it is specified as font identifier 011 in the printer device description.
- **Multiple Page Segments per Page:** Also prints in the default font.
- **Dynamic Positioning for OVL and PSF:** Prints in printer-resident font 85, which is Prestige Elite. This is a printer-resident outline font with the POINTSIZE parameter defining the size.
- **Rotate:** Prints the text “Rotate” in the four different rotations; 0, 90, 180, and 270. Note how the POSITION (2.7 inches down and 6.4 inches across) defines a baseline starting point for each rotation.
- **Lines (Record formats LINE1 and LINE2):** Three vertical and three horizontal lines are printed. The first vertical line begins at a point 1.3 inches down and 2.6 inches across and has a length of 0.2 inches. The line width is *NARROW, which means 0.008 inches wide.

All five parameters of the LINE keyword can be program-to-system variables, enabling the application to dynamically “draw” lines. LINE2 illustrates a dynamic line with all five variables passed from the application.

- **Boxes (Records formats BOX1 and BOX2):** Two boxes are drawn in the DDSFUN3 example. The first (or thicker) box is defined by the top left (0.8 down, 1.0 across) and bottom right (1.5 down, 2.0 across) positions. The box width is 0.1 inch. Box width can also be specified by the *NARROW, *MEDIUM, and *WIDE special values. All five parameters of the BOX keyword can be program-to-system variables, which enables the application to dynamically “draw” boxes. BOX2 depicts an example of a fully dynamic box.

- **Text in Record Format FNT1:** This record format prints text in a number of printer-resident outline fonts. Font 2305 is Helvetica Italic. Font 420 is Courier Bold. Font 2310 is Times New Roman Italic. Font 20224 is boldface.
- **Page Segments:** The IBM logo is dynamically placed using program to system variables for page segment name, down position, and across position. Unlike text, this position marks the top left point of the page segment image (top left when printed in standard orientation or with 0 rotation).

Note: The strawberry image, a page segment called STRWNB is not explicitly placed by DDS. It is part of overlay three.
- **Overlays:** Three simple overlays are shown in the DDSFUN3 example.

“Overlay One” is an AS/400 overlay object (*OVL) called DDSOVL1. It is placed 6.0 down and 1.3 across. This is, again, relative to the page margins and marks the top left point of the overlay.

“Overlay Two” is dynamically referenced from the program by the variable OVLNM2.

“Overlay Three” is dynamically positioned from the program by the variables OV3DWN and OV3ACR for down and across.
- **Barcoding:** Two examples of a barcode are specified. The field BAR1@1 is printed vertically in the Interleaved 2 of 5 barcode, starting at 2.0 down and 1.8 across. The barcode is printed with a height value of 3, which prints a 1/2-inch high barcode. Interleaved 2 of 5 is a numeric-only barcode. The human readable field value (012345678) is printed below the barcode, along with the check digit (4).

The field BAR2@1 is printed horizontally in the Code 3 of 9 barcode starting at 2.0 down and 2.5 across. It prints horizontally because *HRZ is the default. The human readable (01020304) field value is also the default. Note that Code 3 of 9 is an alphameric barcode (up to 50 characters) and does not include a check digit.

B.2 Super Sun Seeds invoicing example

Applying the previous example, we can develop a more relevant application example—the Super Sun Seeds invoice. This application (program INVNEW1) produces a tailored, multi-page invoice. Individual pages are built based on the number of customer transactions. Page components include invoice heading information, item detail information, and invoice totals. The totals also include a payment coupon. In addition, there is a variable marketing offer with a customized image placed on the last page of some invoices.

Figure 227 through Figure 229 on page 295 show how three of the invoice pages turn out.



IMPROVED PRINTING CORP
 PERFORMANCE BOULEVARD
 PRINTERSVILLE
 CO 45789-2637

Customer Number: 100 Invoice Number: 31300 Invoice Date: 2/13/98 Payment Date: 3/13/98

Ship via: BEST WAY Shipped Date: 2/13/98 Terms: NET 30 Salesman: YOUR PRINTER REP

Qty	GN	Trans #	Trans Description	Price	Quantity
1	PK	01100517	SPARTAN SEEDS	2.39	2.39
9	PK	04569870	NORTHERN LITE BLUE SPRUCE	858.32	7,724.88
12	BK	11005004	BUSH GREEN SEEDS	2.50	30.00
12	CT	11005011	LASSO RED SEEDS	892.23	10,706.76
26	PK	11005018	EARLY BANTAM SEEDS	.38	9.88
5	BK	11057893	AFRICAN DAISY, SEEDS	2.35	11.75
1	PK	15975365	HEAVY OAK	129.09	129.09
33	BK	32746510	HOPS BREWING LIGHT	1.20	39.60
6	BA	46578913	SEED SURVEYING SITE	50.00	300.00
2	BK	56413213	POT POT	7.65	15.30
80	PK	65412384	SEED SCRUBBER	888.79	71,103.20
1	PK	84512023	OREGON SPRING TOMATO SEED	.97	.97
2	DZ	96325874	PINEAPPLE-ORANGE SEEDS	1.29	2.58
11	BK	98412096	BLACK BEAUTY ZUCCHINI	2.30	25.30
5	BA	98546320	FROZEN JUICE PROCESSOR	109.90	549.50
1	CT	00000300	HIGH ALTIITUDE WATERMELON	1.01	1.01

Thank You
 Because you have ordered
 over \$500 of seeds this
 year, on your next seed
 order you will receive
 a 5% discount.

This invoice overlay designed using IBM AFP Utilities/400 Total Due \$90,652.21

Return this tear-off strip with your payment. Make Checks Payable to: Super Sun Seeds
Payment is due by: 3/13/98 **Amount Due is:** \$90,652.21

IMPROVED PRINTING CORP
 PERFORMANCE BOULEVARD
 PRINTERSVILLE
 CO 45789-2637

Figure 227. Improved Printing Corp example

Super Sun Seeds
 A Growth Company

400 CRC/Redway
Vegetation, NJ 08009 Office: 609-400-2267
Fax: 609-415-9794

ORGANIC GARDEN SUPPLIES
546 PRODUCE WAY
COLDSPRING
CO 94523-4852

ORGANICS-ON-THE-MOVE
3872 NATURE'S WAY
NORTHBAY
AK 99972-5341

Customer: 136 Invoice Number: 31336 Invoice Date: 2/13/98 Payment Date: 3/13/98

Ship Via: CLEAN TRK Shipped Date: 2/13/98 Terms: NET 30 Salesman: CHRIS SEEDER

Qty	UM	Trans #	Trans Description	Price	Amount
550	CT	00000300	HIGH ALTITUDE WATERMELON	1.01	555.50
100	EA	00001200	ARBOLES DEL SUR	45.00	4,500.00
25	EA	00231300	SEED ROASTER OVEN SET	199.99	4,999.75
150	PK	04569870	NORTHERN LITE BLUE SPRUCE	858.32	29,748.00
2	BX	11005000	FAVA SEEDS	3.90	7.80
2	BX	11005001	PURPLE TEEPEE SEEDS	4.44	8.88
52	BX	11005002	BUSH WAX SEEDS	2.00	104.00
52	BX	11005003	KINGHORN WAX SEEDS	2.13	110.76
8	BX	11005004	BUSH GREEN SEEDS	2.50	20.00
8	BX	11005005	BLUE LAKE GREEN SEEDS	4.00	32.00
2	BX	11005006	KINGHORN WAX SEEDS	3.00	6.00
2	CT	11005007	VENTURE GREEN SEEDS	1.50	3.00
100	CT	11005008	NORTHEASTERN POLE SEEDS	1.29	129.00
100	CT	11005009	KENTUCKY BLUE SEEDS	2.10	210.00
58	CT	11005010	EARLY DWARF DANISH SEEDS	3.01	174.58
58	CT	11005011	LIASSO RED SEEDS	892.23	51,749.34
84	EA	11005012	BLUE MAX SAVOY BEANS	1.23	103.32
84	DZ	11005013	MINCOR NANTES CARROT SEED	.87	73.08
10	DZ	11005014	SCARLET NANTES SEEDS	5.90	59.00
5	DZ	11005014	SCARLET NANTES SEEDS	5.90	29.50
10	DZ	11005015	CHANTENAY SEEDS	2.19	21.90
63	BZ	11005016	TOUCHON SEEDS	2.83	178.29
65	BZ	11005016	TOUCHON SEEDS	2.83	183.95
2	PK	11005018	EARLY BANTAM SEEDS	.38	.76
2	PK	11005019	NORTHERN PICKLING SEEDS	.39	.78
90	PK	11005020	FRENCH PICKLING SEEDS	2.39	215.10
100	BX	11057893	AFRICAN DAISY, SEEDS	2.35	235.00
25	CT	12382910	SUCCATASH SEEDS	.38	9.50
45	CT	13145340	SOUR GRAPE SEEDS	.15	6.75
10	PT	15789342	BLUE BELLES, BRIGHT BLUE	18.57	185.70
50	PK	15975365	HEAVY OAK	129.09	6,454.50
25	EA	31321654	BELLSTAR SEEDS	7.88	197.00
2	EA	31321654	BELLSTAR SEEDS	7.88	15.76
25	DZ	32154657	PETERSBURG PALM TREE	34.90	872.50
6	BZ	32165478	BLACK EYED BANANA	3.01	18.06
45	BX	32746510	HOPS BREWING LIGHT	1.20	54.00
10	CT	35456031	SUNNY SUNFLOWER SEEDS	1.23	12.30
90	CT	00000300	HIGH ALTITUDE WATERMELON	1.01	90.90

This invoice overlay designed using IBM APP Utilities/400 **Customer Copy** Page 1

Figure 228. Organic Garden Supplies example (Part 1 of 2)



400 CPU Parkway Vegetation, NJ 55000		 Super Sun Seeds A Growth Company		Office: 555-400-2367 Fax: 555-415-0794	
ORGANIC GARDEN SUPPLIES					
Customer Number:	136	Invoice Number:	31336	Invoice Date:	2/13/98
Payment Date:		Payment Date:		Payment Date:	3/13/98
Qty	UOM	Code #	Item Description	Price	Extended
18	EA	40113254	FRESH FRUIT CANNED CANNER	22.97	413.46
6	BX	56413213	POT POT	7.65	45.90
1000	PK	64132029	PITLESS PEACH SEEDS	.97	970.00
500	EA	90976412	TREE TRIMMER TUBING	.20	100.00
6	CT	94875081	EARLIROUSE TOMATO SEEDS	.49	2.94
45	BX	98412006	BLACK BEAUTY ZUCCHINI	2.30	103.50
5	EA	98546320	FROZEN JUICE PROCESSOR	109.90	549.50
50	EA	35715924	SEED SIFTER SET	2,900.00	45,000.00
 Thank You Because you have ordered over \$500 of fruit this year, on your next fruit order you will receive a 5% discount.					
This invoice overlay designed using IBM AFP Utilities/400				Total Due	
				\$147,561.56	
Return this tear-off with your payment. Payment is due by: 3/13/98				Make Checks Payable to: Super Sun Seeds Amount Due is: \$147,561.56	
ORGANIC GARDEN SUPPLIES 546 PRODUCE WAY GOLDENHATS CO 945234852					
				Customer Copy	
				Page 2	

Figure 229. Organic Garden Supplies example (Part 2 of 2)

The first page (Figure 227 on page 293) is for a customer with less than 16 transactions so the entire invoice can fit on one page—invoice heading, item detail, marketing offer, totals, and payment coupon. The next two pages (Figure 228 and Figure 229) illustrate a customer whose invoice overflows to two pages. Here the format of page one has been changed to show only invoice heading and item information. Page two is moved up, with abbreviated heading information followed by the balance of the transactions, the marketing offer, the invoice totals, and the payment coupon.

466 CPU Parkway Vigorston, NJ 05020		 Super Sun Seeds A Growth Company		Office: 855-499-2367 Fax: 855-415-9794	
-- Bill To --				-- Ship To --	
Customer Number:		Invoice Number:		Invoice Date:	
Sales Rep:		Shipped Date:		Salesman:	
Qty	UOM	Trans #	Item Description	Price	Ytd/Avail

Figure 231. Overlay for the first page of a multi-page invoice (INVST)

400 CPT Parkway Teaneck, NJ 07666		 Super Sun Seeds A Growth Company		Office: 555-499-2367 Fax: 555-415-9794	
Customer Number:		Invoice Number:		Invoice Date:	
Qty	Unit	Trans #	Item Description	Price	Volume

Figure 232. Overlay for the middle page of a multi-page invoice (INVMID)

400 GPR Parkway Trenton, NJ 08600			 Super Sun Seeds A Growth Company		Office: 888-400-2267 Fax: 615-415-9794		
Customer Number		Invoice Number		Invoice Date		Payment Date	
Qty	UOM	Trans #	Trans Description			Price	Extension
This invoice overlay designed using IBM APP L686cs400						Total Due	
Return this wrap-off strip with your payment. Payment is due by:						Make Checks Payable to: Super Sun Seeds Amount Due is:	

Figure 233. Overlay for the last page of a multi-page invoice (INVLST)

The DDS source that produced this invoicing application (INVNEW1) is shown in Figure 234 on page 300 and Figure 235 on page 301.

```

A* INVNEW1 - Printer File DDS for Super Sun Seeds Invoice
A*      Example 1 (part 1 of 2)
A*
A*
A* Page 1 Top of Invoice
A*- include Name and Address and Invoice Heading information
A*
A      R  INVTOP                SKIPB(10)
A      ZIPPN                    9S      12  BARCODE(POSTNET)
A                                     SPACEA(2)
A      NAME                    25A     12
A      SINAME                   25A     48
A                                     SPACEA(1)
A      STREET                   25A     12
A      STSTRT                   25A     48
A                                     SPACEA(1)
A      CITY                     25A     12
A      STCITY                    25A     48
A                                     SPACEA(1)
A      STATE                    2A      12
A      ZIP                      9S      16  EDIWRD(' - ')
A      STSTE                    2A      48
A      STZIP                    9S      52  EDIWRD(' - ')
A                                     SPACEA(3)
A      CUST#                    6S  0   14  EDTCDE(Z)
A      INVC#                    6S  0   32  EDTCDE(Z)
A                                     49DATE EDTCDE(Y)
A      PAYDAT                   6S  0   66EDTCDE(Y)
A                                     SPACEA(2)
A      SHPVIA                   10A     14
A                                     34DATE EDTCDE(Y)
A      TERMS                    10A     47
A      SLSMAN                   16A     64
A                                     SPACEA(4)
A*
A* Page 2 Abbreviated Header
A*
A      R  INVTP2                SKIPB(10)
A      NAME                    25A     12
A                                     SPACEA(2)
A      CUST#                    6S  0   14  EDTCDE(Z)
A      INVC#                    6S  0   32  EDTCDE(Z)
A                                     49DATE EDTCDE(Y)
A      PAYDAT                   6S  0   66EDTCDE(Y)
A                                     SPACEA(4)
A*
A* Detail Lines
A*
A      R  DETLIN
A      QTY                      4S  0    8  EDTCDE(Z)
A      UOM                      2A     13
A      ITEM#                    8S  0   18
A      ITIMDES                   25A    28
A      SELPRC                    6S  2   58  EDTCDE(J)
A      EXTPRC                    7S  2   70  EDTCDE(J)
A                                     SPACEA(1)
A*
A* Multiple Page Message
A* - Text is in Helvetica 11-point (COH200A0) raster font, or
A* - Text is in Helvetica 11-point (CZH200) outline font
A      R  PAGEOF
A      PAGEON                    4A     POSITION(10.7 7.3)
A                                     FNTRSET(COH200A0 T1V10037)
A      PAGECNT                   2S  0   POSITION(10.7 7.8)
A                                     FNTRSET(CZH200 +
A*                                     (*POINTSIZ 11) T1V10037)
A      EDTCDE(Z)

```

Figure 234. DDS source for the invoicing application (Part 1 of 2)

```

A* INVNEW1 - Printer File DDS for Super Sun Seeds Invoice
A*      Example 1 (part 2 of 2)
A* Invoice Totals
A* - includes Interleaf 2 of 5 barcode
A*
A      R INVBOT                SKIPB(51)
A      TOIDUE                9S 2 67 EDITWRD(' , , $0. -')
A      SPACE(4)
A      PAYDA@                6S 0 25 EDTCDE(Y)
A      TOTD@2                9S 2 67 EDITWRD(' , , $0. -')
A      SPACE(2)
A      NAME@2                25A 12
A      SPACE(1)
A      STRE@2                25A 12
A      BARPRC                15S 0 52BARCODE(INTERL2OF5 3)
A      SPACE(1)
A      CITY@2                25A 12
A      SPACE(1)
A      STAT@2                2A 12
A*     ZIP@2                 9A 16
A*     ZIP@2                 9S 16 EDITWRD(' - ')
A*
A* Offer Print
A* - Font 92 is Courier Italic 12-pitch (printer-resident)
A*
A      R OFFER                SKIPB(43)
A      FONT(92)
A      OFFR@1                24A 36
A      SPACE(1)
A      OFFR@2                24A 36
A      SPACE(1)
A      OFFR@3                24A 36
A      SPACE(1)
A      OFFR@4                24A 36
A      SPACE(1)
A      OFFR@5                24A 36
A      SPACE(1)
A      OFFR@6                24A 36
A      SPACE(1)
A*
A* Images/Page Segments
A* - Dynamic page segment name passed from program
A*
A      R PAGSEG                PAGSEG(&PSEG 7.0 2.6)
A      PSEG                8A P
A*
A* Images/Page Segments
A* - variable overlay name from program
A*
A      R PRTOVL                OVERLAY(&OVLAY 0 0)
A      OVLAY                8A P
A*
A* Endpage forces page advance
A*
A      R ENDPAGE                ENDPAGE

```

Figure 235. DDS source for the invoicing application (Part 2 of 2)

Seven record formats are used in this DDS source:

- **INVTOP**: Full invoice heading information
- **INVTP2**: Abbreviated invoice heading information
- **DETLIN**: Transaction detail lines
- **INVBOT**: Invoice bottom (totals and payment coupon)
- **OFFER**: Marketing offer
- **PAGSEG**: Print variable page segment (image). Segment name passed from the program.

- **PRTOVL**: Print variable overlay. The following overlays are used:
 - **INVALL**: One page invoice
 - **INVFST**: First page of multi-page invoice
 - **INVMID**: Middle page of a multi-page invoice
 - **INVLST**: Last page of multi-page invoice

This invoicing example (INVNEW1) produces an effective business document, making use of electronic forms, barcoding, custom images, and tailored marketing messages. Because the entire document is electronic, it is easily changed. There are a number of enhancements that can be made to the application to further enhance its value.

A fixed overlay can be printed on the back side of selected pages. In the case of invoicing, this might be a page containing the terms and conditions of the invoice. This is called a constant back overlay. Additional electronic copies can be automatically produced and printed in collated sequence. In this example, you might have a customer invoice, a packing list, and a file copy. Information on each copy can be tailored. For example, pricing information can be suppressed on the packing list. Since all DDS document keywords provide for dynamic control, a completely dynamic or “floating” invoice could be produced. In this case, the document is precisely tailored for each customer. For example, if a given customer has 15 transactions, the invoice is designed for exactly 15 transactions.

There are two additional application examples (INVNEW2 and INVNEW3) that implement the preceding enhancements. INVNEW2 implements the copies, price suppression, and constant back overlay. INVNEW3 adds the dynamic (or floating) invoice format. The DDS source for these examples and a comprehensive library of AFP application examples can be found in the AS/400 AFP Programming Sampler at: <http://www.printers.ibm.com/as400>

Appendix C. Print openness

Various combinations of new and enhanced application program interfaces (APIs), new printer file parameters, new printer device description parameters, new output queue parameters, and new printer writer parameters were added in V3R7, and can be used to provide increased print functionality.

Print openness enables IBM or third parties to provide support for:

- Data stream transforms (to PCL, to PostScript)
- Better identification of supported personal print data streams
- Third-party attributes on printer file
- Third-party attributes on printer device description
- Third-party printer attachment
- TCP/IP LAN attached printers
- HP JetDirect LAN protocol printers

Figure 236 shows how the driver and data transform programs provided by the user interface with the open writer and other APIs provided by the system.

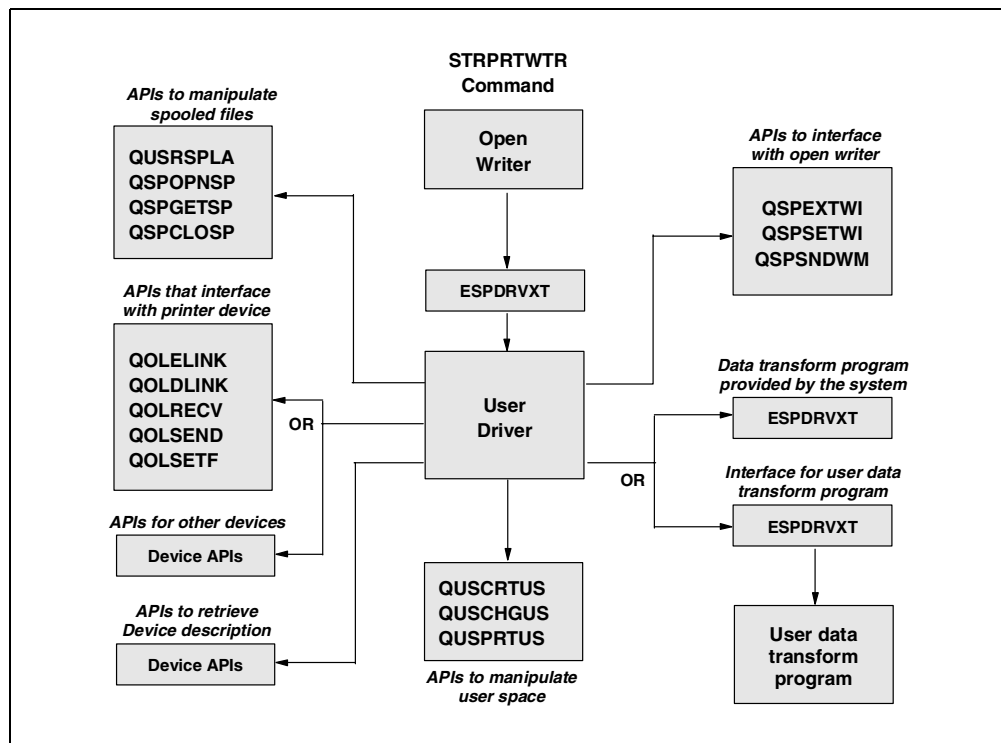

Figure 236. Interface to user driver and data transform programs

The user driver program or any other user application that processes spooled files can find information on how to process a spooled file using attributes such as user-defined options, user-defined data, and user-defined objects. These attributes are associated with output queues, printer devices descriptions, and spooled files.

C.1 Additional functions provided on the printer file

Additional functions provided on the printer file include new parameters on the following commands:

- CRTPRTF: Create Printer File
- CHGPRTF: Change Printer File
- OVRPRTF: Override Printer File

Note: All the parameters added are valid only with SPOOL(*YES).

The new parameters are:

- **USRDFNOPT:** User-defined options that can be used by user applications or user-specified programs that process spooled files. The maximum number of options is four, and the default for the parameter is *NONE. The user can enter any character.
- **USRDFNDA:** User-defined data that can be used by user applications or user-specified programs that process spooled files. The user can enter any character up to 255 characters. The default for the parameters is *NONE.
- **USRDFNOBJ:** User-defined object that can be used by user applications or user-specified programs that process spooled files. The parameter is made up of the qualified object name and the object type. The object name meets the AS/400 object naming convention. The possible choices for object types are: *DTAARA, *DTAG, *FILE, *USRIDX, *USRQ, *USRSPC, and *PSFCFG. The single default for the parameter is *NONE.

In addition, the following commands and APIs are enhanced:

- The Display File Description (**DSPFD**) command is enhanced to display the new parameters added to the printer file.
- The Display Override (**DSPOVR**) command is enhanced to display the new parameters added on the OVRPRTF command.
- The Work with Spooled File Attributes (**WRKSPLFA**) command is enhanced to display the new parameters added to the printer file.
- The Change Spooled File Attributes (**CHGSPLFA**) command is enhanced to support the parameters added to the printer file.
- The Retrieve Spooled File Attributes (**QUSRSPLA**) API is enhanced to support the new printer file level of functions as new attributes.
- The Create Spooled File (**QSPCRTSP**) API is enhanced to support the new printer file level of functions as new attributes.

C.2 Additional functions provided on the PRTDEVD commands

Additional functions are provided on the printer device description commands:

- CRTDEVPRT: Create Device Description Printer
- CHGDEVPRT: Change Device Description Printer
- DSPDEVD: Display Device Description

The new parameters are:

- **USRDFNOPT:** User-defined options that can be used by user applications or user-specified programs that process spooled files. The maximum number of options is four, and the default for the parameter is *NONE. The user can enter any character.
- **USRDFNOBJ:** User-defined object that can be used by user applications or user-specified programs that process spooled files. The parameter is made up of the qualified object name and the object type. The object name meets the AS/400 object naming convention. The possible choices for object type are *DTAARA, *DTAG, *FILE, *USRIDX, *USRQ, *USRSPC, and *PSFCFG. The single default for the parameter is *NONE.
- **USRDTATFM:** User-specified program to transform the spooled file data before it is processed by the driver program. The default value for the parameter is *NONE.
- **USRDRVPGM:** User-specified driver program to process the spooled file. The default value for the parameter is *NONE.
- **RMTLOCNAME:** Specifies the remote location name of printer device. This value may be an SNA network ID and control point name, an Internet protocol (IP) host name, or an Internet address.
- **LANATTACH:** Specifies the driver type that is used to attach the printer to the network. The possible values are:
 - *LEXLINK: LexLink attachment
 - *IP: TCP/IP attachment
 - *USRDFN: User-defined attachment

C.3 Additional functions provided on the output queue commands

Additional functions are provided on the output queue commands:

- CRTOUTQ: Create Output Queue
- CHGOUTQ: Change Output Queue

The added parameters are:

- **USRDFNOPT:** User-defined options that can be used by user applications or user-specified programs that process spooled files. The maximum number of options is four, and the default for the parameter is *NONE. The user can enter any character.
- **USRDFNOBJ:** User-defined object that can be used by user applications or user-specified programs that process spooled files. The parameter is made up of the qualified object name and the object type. The object name meets the AS/400 object naming convention. The possible choices for object type are *DTAARA, *DTAG, *FILE, *USRIDX, *USRQ, *USRSPC, and *PSFCFG. The single default for the parameter is *NONE.
- **USRDTATFM:** User-specified program to transform the spooled file data before it is processed by the driver program. The default value for the parameter is *NONE.

Note: In V4R2, a sample transform exit program that supports page range processing when using a remote output queue (LPR) is shipped in the QUSRTOOL library. The tool is called TSPRWPR.

- **USRDRVPGM**: User-specified driver program to process the spooled file. The default value for the parameter is *NONE.

In addition, the following parameters and commands are enhanced:

- New values in the **DESTTYPE** (Destination Type) parameter and the **CNNTYPE** (Connection Type) parameter to support Host-to-LAN printing with the Integrated PC Server NetWare.
- New parameter **SEPPAGE** (Separator Page) specifies whether to request a separator page when the connection type is *IP or *USRDFN.
- The **WRKOUTQD** command is enhanced to display the new and changed output queue attributes.

C.4 Additional functions

Other functions that are provided include:

- Two new APIs are added: Change Output Queue (**QSPCHGOQ**) and Change Configuration Description (**QDCCCFGD**). The first one can be used to change some attributes of an output queue, and the other one can be used to change some of the attributes of the device description. Also both can change a new attribute called User Defined Data. This parameter can be extracted by a driver program using either the QSPROUTQ (Retrieve Output Queue Information) API or the QSPRDEVD (Retrieve Device Description Information) API. The maximum length of the user-defined data is 5000 and the default for the attribute is *NONE.
- The User Data Transform (**USRDTATFM**) parameter is added to the Send TCP Spooled File (SNDTCPSPLF) command. The user can specify the name of a transform program to use instead of the host print transform.
- The Separator Page (**SEPPAGE**) parameter is added to the Send TCP Spooled File (SNDTCPSPLF) command that allows the user the option to print a banner page or not.
- The Start Print Writer (STRPRTWTR) command includes a new parameter called **INIT**. It allows the user to specify whether to initialize the printer device.
- The new DDS keyword Data Stream Command (**DTASTMCMD**) is added that allows users to store information in the data stream of the spooled file. The information is enclosed within an AFPDS NOOP command. This keyword is valid with AFPDS spooled files only.

C.5 Print openness: New APIs

The following APIs are added mainly to assist driver programs processing spooled files:

- **QSPEXTWI** (Extract writer status):
Can be used by a print driver exit program to extract information about the writer and about the spooled file the writer is processing.
- **QSPSETWI** (Set writer status):
Can be used by a print driver exit program to set information related to the spooled files the writer is processing.

- **QSPSNDWM** (Send writer message):
Can be used by a print driver exit program to send informational and inquiry messages to the writer's message queue.
- **ESPDRVXT** (Print driver exit):
Defines how a user-defined print driver exit program must be written to be used with the AS/400 print writer program.
- **ESPTRNXT** (Writer transform exit):
Defines the interface between a user-defined transform program and the AS/400 print writer program.
- **QWPZHPTR** (Host print transform API):
Host print transform API to access the SCS to ASCII transform or the AFPDS to ASCII transform.
- **QSPBSEPP** (Build separator page):
Builds the system separator page to be printed for the spooled file.
- **QSPBOPNC** (Build open time commands):
Builds “open time” commands for the spooled file. The “open time” commands contain most of the file level commands needed to format the printed output.
- **QGSLRSC** (List spooled file AFPDS resources):
Generates a list of the AFPDS resources found in the specified spooled file and returns the list in a user space.
- **QGSCPYRS** (Copy AFPDS resources):
Puts AFPDS data stream equivalent of the specified AFPDS resource into the specified user space.

For detailed information on APIs, see *AS/400 System API Reference*, SC41-5801.

Appendix D. Network Station printing

The IBM Network Station has both a parallel port and a serial port, either of which can be used to print to an attached printer. The ports appear to the internal operating system as TCP/IP sockets, to and from which bytes may be read and written. This is the mechanism that makes printing to a printer attached to the IBM Network Station parallel or serial port possible.

In addition, use the IBM Network Station Manager program (through the browser) to ensure that the “Parallel printer port” setting is “On” (the default) to enable printing support on the IBM Network Station.

D.1 Printing from OS/400

Each IBM Network Station can have a printer attached to either its parallel or serial port. The printer must also be supported by the OS/400 host print transform. Any AS/400 user in the network can print AS/400 output to the printers attached to the IBM network stations.

D.1.1 AS/400 Network Station printer driver

Printers attached to IBM Network Stations are supported through the standard printing subsystem through host print transform. You can use a wide variety of different models from different manufacturers. Also, all printing functions are supported such as:

- Printing page ranges
- Printing a separator page
- Limited printer status reporting

AS/400 Network Station print driver operation

Since the IBM Network Station is attached to a LAN, its printer can be shared between several hosts. This is made possible by the way the printer writer operates. The operation of the printer writer serving an IBM Network Station attached printer is slightly different than that of other printer writers.

When this printer writer is started, it establishes a session to the IBM Network Station and checks the availability of the printer. If the session cannot be established within the activation timer value, a message is sent to the operator. If there are spooled files on the output queue, the writer sends them to that IBM Network Station's printer. If there are no more spooled files on the output queue, the printer closes the session with the IBM Network Station printer after the inactivity timer expires. Closing this session allows other servers to print on the IBM Network Station printer. In addition, if you end the printer writer, it also closes the session with the printer.

If new files become ready on the output queue, the writer tries to establish a new session with the IBM Network Station printer.

D.1.2 Creating printer device descriptions

You must create a device description for each printer attached to an IBM Network Station. You can either use the IBM Network Station Setup Assistant (STRNSSA) Task 4300, or you can create the necessary printer device descriptions manually.

If you choose to create printer device descriptions with the CRTDEVPRT command, the following values *must* be used:

- **Device class:** Choose ***LAN**.
- **Device type:** Choose **3812**.
- **Device model:** Choose **1**.
- **LAN attachment:** Choose ***IP**. This indicates that the printer is using TCP/IP communications.
- **Port number:** Choose **6464** for a parallel port attached printer and **87** for a serial port attached printer.

Note: A serial port attached printer should have its serial interface set to the following values:

- Baud rate: 9600 bps
- Data bits: 8 bits
- Parity: none
- Stop bit: 1
- Handshaking: DTR/DSR

- **Activation timer:** This value specifies the amount of time (in seconds) to wait for the device to respond to an activation request. If a response is not received within this time, message CPA337B is returned. This message asks the operator if the request should be retried or canceled.

Choose any value that is suitable for your environment.

Note: If you use Task 4300 of the IBM Network Station Setup Assistant, this value defaults to 500 seconds.

- **Inactivity timer:** Choose ***ATTACH**. This value varies by the value on the physical attachment (ATTACH parameter) and certain values on the device class (DEVCLS) and application type (APPTYPE) parameters. For DEVCLS(*SNPT) or APPTYPE(*DEVINIT) support, *ATTACH maps to *NOMAX. For DEVCLS(*LAN), *ATTACH maps to *SEC15. For APPTYPE(*NRF) and APPTYPE(*APPINIT) support, *ATTACH maps to 1 minute.

You may specify an interval between 1 minute and 30 minutes or the special values *SEC15, *SEC30, or *NOMAX.

The IBM Network Station handles only one activation request at a time from any host. The Inactivity Timer parameter allows sharing the printer device among several hosts. After the time you specified has elapsed, the writer job releases the device if there are no more spooled files to print. If you specify *NOMAX for the Inactivity Timer parameter, the writer keeps the connection to printer active until you stop the printer writer. Therefore, using *NOMAX effectively prevents sharing the printer.

Note: If you use Task 4300 of the IBM Network Station Setup Assistant, this value defaults to 1 minute.

- **Host print transform:** Choose ***YES**. This is required to transform AS/400 EBCDIC data to ASCII data.
- **Manufacturer type and model:** Type in the value that reflects the printer to be configured. To determine that value, you can press the Help key to view the list of supported printers.

- **Remote location name:** Specify the IP address or the name of the IBM Network Station to which the printer is attached.

Note: If you want to specify the name, you must first create an entry in the TCP/IP Host Table.

- **System driver program:** Specifies the printer driver type to be used for this configuration. For IBM Network Station attached printers, this value must be *NETSTNDRV.

D.2 Local printing

This section outlines aspects of local printing.

D.2.1 5250 screen copy to a local printer

If you click the Print pull-down option in the 5250 emulator, you can select local or host print. If you click *Local*, the contents of the 5250 session window can be printed on the IBM Network Station directly-attached printer. If you click *Host*, the AS/400 system print function is invoked, and you see the message “Print operation complete to the default printer device file”.

D.2.2 Printing from Java

Java is the only language in which IBM Network Station applications can be written. Release 2.5+ of the IBM Network Station software includes an implementation of Sun's 1.1 JVM, which includes the ability to print with Java applications.

Note: All printing through the JVM generates PostScript output. Page Layout is the responsibility of the Java application. Untrusted applets are not allowed to create print jobs.

An overview for developers, written by Sun, can be found at:

<http://java.sun.com/products/jdk/1.1/docs/guide/awt/designspec/printing.html>

As part of this support, it is possible to send Java application output to the AS/400 system through LPR/LPD. Typically, you have a print dialog that allows you to specify a print destination of PARALLEL1, SERIAL1, or a remote print destination in the form of `QueueName@ServerName`. The first two values direct output to a locally attached printer, while the third value causes output to be sent to a remote system (which can be an AS/400 system) through LPR/LPD.

As previously noted, the output is generated in PostScript. Therefore, you need to make sure that the printer the AS/400 system ultimately routes the spooled data to is capable of printing PostScript.

Appendix E. Printer summary

This appendix provides a summary of AS/400 system-supported printers, including IBM production printers, IBM industrial printers, and IBM workgroup printers.

Table 24. IBM production printers for the AS/400 system

IBM AS/400 printer	Max speed	Technology	Resolution	Attachment	Data stream	Features
Infoprint 60	60 ipm	Laser	600 x 600 (240 and 300 dpi input accepted)	IP Token Ring IP Ethernet SNA Token Ring	IPDS PCL	High speed/capacity AFCCU control unit Up to 4 input bins 750,000 imp/month Cut sheet/duplex Multi-function finisher includes stapling, folding, saddle stitching, insertion
Infoprint 62	62 ipm	Non Contact Flash Fusing Laser	240 x 240 300 x 300	IP Token Ring IP Ethernet SNA Token Ring	IPDS	Continuous form AFCCU control unit Wide forms (to 14-1/2") Power Stacker option
Infoprint 70	70 ipm	Laser	600 x 600	IP Token-Ring IP Ethernet	IPDS PostScript/PCL (supported via a print server)	Homerun Control Unit High capacity input Finishing, including stapling 400k impressions/month
Infoprint 2000	110 ipm	Laser	600 x 600	SNA Token Ring, IP Token Ring IP Ethernet	PostScript 3 PCL IPDS Note: PCL and PostScript 3 support through print server transforms.	High speed, high volume, high fidelity Up to 2.0million imp/month Cut sheet
Infoprint 3000	Up to 334 ipm	Laser	600 x 600,	SNA Token Ring, IP Token Ring IP Ethernet	IPDS	High speed, high volume, 18" print width = 2-up Simplex, duplex, Intelligent Post-Processing, Up to 17.4 million imp/mo Continuous form
Infoprint 4000	Up to 1002 ipm	Laser	240 x 240, 300 x 300, 480 x 480, 600 x 600,	SNA Token Ring IP Token Ring IP Ethernet	IPDS	High speed, high volume, Resolution to 600 dpi 18" print web = 2-up Simplex, duplex, Intelligent Post-Processing, Up to 17.4 million imp/mo Continuous form
Infoprint 4000 HiLite Color	Up to 1002 ipm	Highlight Color Laser	240 dpi 300 dpi	Attaches to Infoprint 4000 and IBM 3900	IPDS	High speed, high volume color Continuous Form

Table 25. IBM industrial printers for the AS/400 system

IBM AS/400 printer	Speed	Technology	Resolution	Attachment	Data stream	Features
4230	375 cps - 600 cps	Dot Matrix	Varies by print quality mode	Twinax, Serial/Parallel IPDS LAN (7913) ASCII LAN (NPS)	IPDS SCS ProPrinter	Heavy Duty IPDS graphics, barcode Easy to use Very Quiet (53 dBA)
4232	600 cps	Dot Matrix	Varies by print quality mode	Serial or Parallel ASCII LAN (NPS)	ProPrinter or 4224-3XX	Heavy duty Easy to use Very quiet (53 dBA)
4247	700 cps	Dot Matrix	Varies by print quality mode	Twinax Serial/Parallel IPDS LAN (7913) ASCII LAN (7913)	IPDS SCS ProPrinter or Epson	Up to 6 inputs 2 continuous forms Up to 8-part forms Quiet (55 dBA)
6400 Cabinet	500 lpm 1000 lpm 1500 lpm	Line Matrix	Varies by print quality mode	Twinax, Serial/Parallel, IP Ethernet IPDS ASCII Ethernet	IPDS ProPrinter, Printronics Epson SCS Code V, IGP	Heavy Duty Very Quiet (52 dBA) Low cost of operation Web-controlled Op panel NPM support
6400 Pedestal	500 lpm 1000 lpm	Line Matrix	Varies by print quality mode	Twinax, Serial/Parallel, IP Ethernet IPDS IP Ethernet ASCII	IPDS ProPrinter, Printronics Epson SCS Code V, IGP	Heavy Duty Low cost of operation Web-controlled Op panel NPM support
4400 Thermal Label Printer	6-10 Inches Per Second	Thermal	300 dpi 203 dpi	Twinax Serial/Parallel IP Ethernet IPDS IP Ethernet ASCII	IPDS ProPrinter Printronics Epson SCS Code V, IGP	4, 6, 8 inch width models Heavy-duty Industrial Design Remote Web Management Barcode verifier Cutter

Table 26. IBM workgroup printers for the AS/400 system

IBM AS/400 printer	Speed	Technology	Resolution	Attachment	Data stream	Features
Infoprint Color 8 (4308)	8 ppm	Full Color Laser	600 x 600	Serial/Parallel, Ethernet, Token Ring	PCL5e PostScript 3	35,000 imp/month AS/400 Support via Host Print Transform
Network Printer 12 (4312)	12 ppm	Laser	300 x 300 600 x 600	Twinax, Serial/Parallel, Ethernet (10/100), Token Ring	IPDS SCS PCL5e PostScript	IBM Integrated AFP/IPDS 35,000 imp/month Edge to Edge Printing
Infoprint 12 (4912)	12 ppm	Laser	1200 x 1200	Parallel, Ethernet	PCL6 PostScript 3	Low cost, entry network printer 20,000 imp/month
Network Printer 17 (4317)	17 ipm	Laser	300 x 300 600 x 600	Twinax, Parallel, Ethernet, Token Ring	IPDS SCS PCL5e PostScript	IBM Integrated AFP/IPDS 65,000 imp/month 10 bin mailbox Cut sheet/duplex

IBMAS/400 printer	Speed	Technology	Resolution	Attachment	Data stream	Features
Infoprint 20 (4320)	20 ppm	Laser	600 x 600 1200 x 1200	Twinax, Parallel, Ethernet (10/100), Token Ring	IPDS SCS PCL5e PostScript 3	IBM Integrated AFP/IPDS 75,000 imp/month 11 by 17 support Cut sheet/duplex
Infoprint 21 (4321)	21 ppm	Laser	600 x 600 1200 x 1200	Twinax, Parallel, Ethernet (10/100), Token Ring	IPDS SCS PCL6 PostScript 3 PDF	IBM Integrated AFP/IPDS Integrated web server Label-ready Web-based management IPP-enabled
Infoprint 32 (4332 001)	32 ppm	Laser	600 x 600 1200 x 1200	Twinax, Parallel, Ethernet (10/100), Token Ring	IPDS SCS PCL5e PostScript 3	IBM Integrated AFP/IPDS 150,000 imp/month 11 by 17 support Cut sheet/duplex High-function finisher includes stapling, collation
Infoprint 40 (4332 002)	40 ppm	Laser	600 x 600 1200 x 1200	Twinax, Parallel, Ethernet (10/100), Token Ring	IPDS SCS PCL5e PostScript 3	IBM Integrated AFP/IPDS 200,000 imp/month 11 by 17 support Cut sheet/duplex High-function finisher includes stapling, collation

Appendix F. PSF/400 performance results

This appendix contains selected results from a PSF/400 V4R2 performance evaluation. The performance evaluation was performed by the IBM Printing Systems Company Performance Group in Boulder, Colorado.

F.1 Environment

PSF/400 V4R2 printing performance was measured using an AS/400 Model 510/2144 processor with IBM Network Printer 24, IBM Infoprint 60, and IBM Infoprint 4000 printers attached to a dedicated 16 MB Token-Ring. The AS/400 system was totally dedicated to printing with no other processes active except for measurement. The printer Token-Ring was connected only to the AS/400 system and one of the printers at any one time.

The AS/400 Model 510/2144 is a low to medium performance system relative to the other current AS/400 models. Based on V4R1 Commercial Processing Workload (CPW) ratings, the Model 510/2144 system's performance compares to other selected models as shown in Table 27.

Table 27. Performance comparison of some AS/400 models

Model	V4R1 CPW ratings
500	21.4 to 43.9
600	22.7 to 73.1
510/2144	111.5
620	85.6 to 464.3
530	148.0 to 650.0
640/2237	319.0
640/2238	563.3
640/2239	998.6
650	1,794.0 to 2,743.6
840	16,500

F.1.1 Software

The PSF/400 V4R2 software was preliminary GA level, believed to represent GA level performance. Software parameters relevant to performance were set to:

- 10,000 KB Spool (QSPL) Storage
- 8 KB Receive Buffer size
- 8 KB (NP24) and 32 KB (IP60 and IP4000) Send Buffer sizes
- 4096 byte MTU size
- 16 KB Maximum Frame size

F.1.2 Hardware

The AS/400 system that was used included this setup:

- Model 510
- Processor Type 2144
- 512 MB Memory
- 28 GB DASD
- 2619-001 IOP/Token-Ring adapter
- 16MB Token-Ring

Performance was evaluated using three printers, each attached to the AS/400 system by means of a 16 Mb Token-Ring.

- Network Printer 24 (NP24/4324):
 - IPDS, PCL, or PostScript
 - Cut-sheet
 - 24 pages per minute (PPM) simplex, 19 PPM duplex
 - 300 dpi resolution
 - 20 MB memory
- Infoprint 60 (IP60):
 - IPDS only
 - Cut-sheet
 - 60 PPM, both simplex and duplex
 - 240 and 300 dpi resolution (prints at 600 dpi)
 - 64 MB of memory
- Infoprint 4000 (IP4000):
 - IPDS only
 - Continuous forms
 - 708 PPM (2-up duplex)
 - 240 dpi resolution
 - 128 MB of memory

This IP4000 “printer” was actually a laboratory device that is based on a real IP4000 control unit, but simulates the paper and imaging hardware of the real IP4000. In function and performance, it represents the IP4000 faithfully except for the lack of printed output.

F.2 Methodology

The parameters for determining PSF/400 V4R2 performance are:

- **Time for the first page to print and total job time:** These are the elapsed times between job submission and printing the first page of the job, and between job submission and printing the last page of the job. For the IP4000, the time for the first page was assumed to be when the operator panel displayed “Printing”.
- **Spooled file conversion throughput:** This is defined as the rate of converting the spooled file in pages per minute (PPM), from the first page of the job until the last page of the job. This is determined from Start and End time stamps for the spooled file conversion process of PSF/400.
- **Printer throughput:** This is defined as the rate of printing in pages per minute (PPM), from the first page of the job until the last page of the job.

Instrumentation was used with the IP4000 to arrive at steady-state printing rates more accurately.

- **PSF/400 V4R2 use of the AS/400 system processor:** This is the use of the processor during both the PSF/400 spooled file conversion and printer driver phases, where appropriate. It is reported both as percent utilization and as processor time (milliseconds) per page converted and printed.

The procedure for PSF/400 V4R2 measurements begins with complete isolation of the AS/400 system from all connections other than the printer, and de-activation of all processes other than PSF/400 and the Performance Monitor. Files to be measured have already been placed on the spool. Each measurement is made using this procedure:

1. Print a few pages of the job to be measured to make sure fonts and other resources have been downloaded to the printer before the measurement starts.
2. Start PSF Trace to record start and stop times for the spooled file conversion and printer driver phases of PSF/400. While PSF Trace can have a large effect on performance if it is not used carefully, using it to record this limited data has no measurable effect.
3. Start the Performance Monitor to gather information about processor use while converting and printing.
4. Release the spooled file to be measured, starting a timer at the same time.
5. Record the time at which the first page has been printed and dropped into the output hopper (cut sheet printers) or shown as “printing” (IP4000).
6. Record the time at which the last page has been printed.
7. Stop the Performance Monitor and PSF Trace.
8. Retrieve start, stop, and processor use information for the spooled file conversion and printer driver from information recorded by PSF Trace and Performance Monitor.

This information is then processed as a spread sheet, and the results are tabulated.

F.3 Performance cases

Twenty-three print jobs were used, although not all with any one printer. Fifteen print jobs are native AS/400 applications. Many of these were produced as sample programs for marketing demonstrations (for example, Super Sun Seeds) or are variations of sample programs. AS/400 applications typically specify print-resident fonts.

One of the native AS/400 jobs and two others were printed using the host print transform facility of the AS/400 for a total of 26 distinct cases. These cases are shown in Table 28 on page 320 with descriptions of their origins and characteristics.

Eight print jobs are from a set of AFP (Performance Reference Pages that have been used to evaluate performance of PSF products and printers for some time). Some of them use downloaded fonts that are not in the current Core Interchange set, which can cause PSF/400 and printers to process the job differently.

Applications such as these (common in the MVS environment) typically specify and use downloaded fonts. These jobs represent complex AFP applications. They were imported to the AS/400 spool.

Some of these jobs produce output that appears the same as or similar to the output of another job, using a different form with different performance characteristics. These similarities in appearance are noted in the descriptions.

Table 28. Names and descriptions of performance cases

Case name	Case description
INVPRE	Text with overlay. Produces one version of the Super Sun Seeds invoice application. INVPRE is an SCS application where the invoice overlay has been added using the Printer File (that is, OVRPRTF). Sample output from this test case is shown in Figure 237 on page 334.
INVNEW2	Text with overlays and barcodes. Produces an AFP version of Super Sun Seeds invoice using DDS. Each invoice can have multiple customized pages. Each invoice has three collated copies—customer, packing list, and file—each of which is different. Sample output from this test case is shown in Figure 238 on page 334.
INVNEW2A	Same as INVNEW2 but without barcodes. Sample output from this test case is shown in Figure 239 on page 335.
INVNEW3	Text with overlays and barcodes. A more sophisticated version of Super Sun Seeds invoice using DDS. Each page is <i>drawn</i> (using dynamic variables in DDS) to match the number of customer transactions. Appearance is the same as INVNEW2. Sample output from this test case is shown in Figure 238 on page 334.
INVNEW3A	Same as INVNEW3 but without barcodes. Appearance is the same as INVNEW2A. Sample output from this test case is shown in Figure 239 on page 335.
INVSCS	Text with overlays. Advanced Print Utility (APU) version of Super Sun Seeds invoice application. INVSCS is the original application, creating flat SCS for a preprinted invoice form. Using an APU print definition, the SCS spooled file is transformed into an AFP spooled file. This case uses the AFP spooled file. Sample output from this test case is shown in Figure 240 on page 335.
INVPDEF	Text with overlays. This is a Super Sun Seeds invoicing application formatted by using page and form definitions. Using an override to the printer file, the original SCS application is switched to line data, and the page definition and form definition are added. Sample output from this test case is shown in Figure 241 on page 336.
INVPDEFA	An invoicing application similar to INVPDEF, using fewer overlays and different data. Appearance is somewhat similar to INVPDEF. Sample output from this test case is shown in Figure 241 on page 336.
SHLFLB	30 labels, with a barcode on each label. This shelf label application was created using the Print Format Utility (a module of AFP Utilities). Sample output from this test case is shown in Figure 242 on page 336.
SHLFLBA	30 labels, with a barcode on each. Shelf application from PFU. This is not the same application as SHLFLB, but it is similar in appearance. Sample output from this test case is shown in Figure 242 on page 336.
SCS	57 132-character lines of SCS data. Plain text in SCS format. Sample output from this test case is shown in Figure 243 on page 337.

Case name	Case description
SCSA	29 72-character lines of SCS data. Plain text in SCS format. This is not the same application as SCS. Sample output from this test case is shown in Figure 244 on page 337.
SCS-PT	57 132-character lines of SCS data printed using passthrough. The appearance is the same as SCS. Sample output from this test case is shown in Figure 243 on page 337.
SCS-PTA	29 72-character lines of SCS data printed using passthrough. The appearance is the same as SCSA. This is not the same application as SCS-PT. Sample output from this test case is shown in Figure 244 on page 337.
SCS-PDEF	57 132-character lines of unformatted line data. Same text as SCS printed with the same appearance using a page definition.
TXT8K-HPT	8000 text characters. This is the TXT08K case done with host print transform (for a PCL printer). The appearance is similar to TXT08K. Sample output from this test case is shown in Figure 245 on page 338.
CMLIM-HPT	Complex text with IM image, 49325 bytes total. This is the TXTTCMLIM case done with host print transform (for a PCL printer). The appearance is similar to TXTCMLIM. Sample output from this test case is shown in Figure 247 on page 339.
INVN2-HPT	Text with overlays. This is the INVNEW2 case done with host print transform (for a PCL printer). Appearance is similar to INVNEW2.
TXT08K	Simple DCF text pages of 8000 text characters each, format off, one downloaded font (gothic). Direction of printing is done, and there are 9346 bytes per page (text and controls). Sample output from this test case is shown in Figure 245 on page 338.
TXT32K	Simple DCF text pages of 32000 text characters each, format off, one downloaded font (gothic). Direction of printing is done and there are 35951 bytes per page (text and controls). Sample output from this test case is shown in Figure 246 on page 338.
TXTCMLIM	Complex DCF text pages of 4799 text characters each, two columns of justified text, with eight different downloaded fonts (Sonoran), three tables, and a 5.2 square inch GDDM (ceiled) image on each page. Direction of printing is down, and there are 40325 bytes per page (text, image and controls). Sample output from this test case is shown in Figure 247 on page 339.
STMTSHAD	Complex billing statement pages using OGL overlays. The overlay contains two images (3.36 square inches total), and 306 text characters, and has 19467 bytes total (text, image, and controls). 47 lines of 12 fields of variable data are printed on each page (using pagedef specifications) for another 7674 bytes per page (text and controls). Seven downloaded fonts are used (Sonoran and Prestige Pica). Note that the overlay is stored in the printer's memory and does not have to be retransmitted for every page. Sample output from this test case is shown in Figure 248 on page 339.
RAST24	Pages containing one simple image page segment of 24 square inches. Page segment source is PMF. 173138 bytes per page (image data and controls). Sample output from this test case is shown in Figure 249 on page 340.

Case name	Case description
RAST50	Pages containing one simple image page segment of 50 square inches. Page segment source is PMF. 360453 bytes per page (image data and controls). Sample output from this test case is shown in Figure 250 on page 340.
CHKSG410	Pages each containing 10CCITT Group 4 compressed 240 dpi IOCA checks of 4.09 square inches each. 43478 bytes per page (image data and controls). Sample output from this test case is shown in Figure 251 on page 341.
G479BO52	Pages each containing one 79 square inch CCITT Group 4 compressed 240 dpi IOCA image (5:1 compression). 109819 bytes per page (image data and controls). Sample output from this test case is shown in Figure 252 on page 341.

F.4 Results

Seven tables of performance information follow. Table 29, Table 30 on page 324, and Table 31 on page 325 show the number of pages printed and the performance results for each case used with the NP24, IP60, and IP4000 printers. Table 32 on page 326 and Table 33 on page 328 summarize and compare printing rates and processor use for the three printers. Table 34 on page 330 shows calculated AS/400 Model 510/2144 processor utilization based on measured processor use, at NP24, IP60, and IP4000 maximum printing rates. Table 35 on page 331 compares the performance effects of operating PSF/400 in simultaneous print and convert mode (Print While Convert (PNC) = YES) to operating with PWC=NO.

F.4.1 PSF/400 V4R2 with Network Printer 24

The NP24 printer is a cut-sheet printer with 300 dpi resolution, with maximum printing speeds of 24 PPM (simplex) and 19 PPM (duplex) using letter sized paper. Some jobs were printed in duplex, some in simplex, and one (INVSCS) is a mixed simplex and duplex application. All NP24 measurements were made with PWC=NO, which causes printing to wait until spooled file conversion is complete (Table 29).

Table 29. NP24 performance with PSF/400 V4R2 (AS400 Model 510/2144): Print While Convert=NO

Case	No. of pages	Page times		Conversion		Printing		Processor Time		
		(mins:secs)		Rate	Util	Rate	Util	per page (msec)		
		First	Last	(PPM)	(%)	(PPM)	(%)	Cvt	Prt	Tot
INVPRE	80	:19	3:35	1,811	26	24	.1	8.5	1.9	10.4
INVNEW2	80	:30	4:39	1,644	36	19	.1	13.3	2.0	15.3
INVNEW3	80	:30	4:42	623	37	19	.3	13.1	8.8	21.9
INVSCS	80	:30	6:13	1,733	33	13	.1	11.5	2.1	13.6
INVPDEF	80	:31	4:33	1,314	30	19	.0	13.5	1.3	14.7
SHLFLB(s)	80	:24	3:39	694	78	24	.1	67.6	2.5	70.1
SCS(s)	80	:19	3:34	1,890	51	24	.1	12.0	1.0	13.0

Case	No. of pages	Page times		Conversion		Printing		Processor Time		
		(mins:secs)		Rate	Util	Rate	Util	per page (msec)		
		First	Last	(PPM)	(%)	(PPM)	(%)	Cvt	Prt	Tot
SCS-PT(s)	80	:18	3:33	2,927	59	24	.0	12.0	1.0	13.0
SCS-PDEF	80	:19	3:33	2,133	22	24	.1	6.1	1.5	7.6
TXT8K-HPT	80	:54	4:56	na	na	19	4*	na	na	123.4
CMLIM-HPT	80	:1:15	5:16	na	na	19	10*	na	na	309.8
INVN2-HPT	90	1:30	6:02	na	na	19	12*	na	na	399.0
TXT08K	80	:26	4:35	5,926	54	19	.1	5.5	1.8	7.3
TXT32K	80	:31	4:42	1,638	31	19	.1	11.3	4.0	15.3
TXTCMLIM	80	:32	4:41	1,182	47	19	.2	23.6	5.3	28.9
STMTSHAD	80	:40	6:08	845	61	14	.0	43.4	2.0	45.4
RAST24	80	:41	4:50	612	42	19	.4	41.5	14.4	55.9
RAST50	80	:55	10:01	298	41	8	.6	82.3	43.9	126.1
CHKSG410	80	:36	4:44	1,069	61	19	.1	34.1	4.1	38.3
G479BO52	80	:43	13:14	740	39	6	.1	31.6	9.6	41.3

Notes:

(s) Indicates simplex printing.

* Since there are no distinct conversion and printing processes with HPT, all processor use and utilization are shown under "Printing".

- **No. Pages:** The total number of pages printed for the job. For duplex jobs, this is twice the number of sheets produced by the printer.
- **Page Times:** The number of minutes and seconds (from the time the job was released from the spool) until the first and last pages were printed.
- **Conversion Rate:** The rate in pages per minute at which the spooled file was converted prior to printing.
- **Conversion Util:** The percent of the time the AS/400 processor was busy while the spooled file was being converted. When no other work is using the processor (as in these measurements), the spooled file conversion process uses as much processor time as it can and converts at a high rate. When other processors are running, as they normally are, utilization for conversion is higher and the conversion rate is lower.
- **Printing Rate:** The rate in pages per minute at which pages were printed.
- **Printing Util:** The percent of the time the AS/400 processor is busy while the spooled file is being printed. For a given job, printing utilization is approximately proportional to the printing rate.
- **Processor Time per Page:** The milliseconds of time during which the processor is busy for each page converted, printed, and totalled. This number is independent of the rate at which pages are being printed.

F.4.2 PSF/400 V4R2 with IP60

The IP60 printer is a cut-sheet printer with both 240 dpi or 300 dpi resolutions. It prints at 600 dpi in either case. Its maximum printing speed is 60 PPM in both simplex and duplex when using letter sized paper. Some jobs are printed in duplex, some in simplex, and one (INVSCS) is a mixed simplex and duplex application. The IP60 measurements shown in Table 30 on page 324 were made with PWC=NO, which causes printing to wait until the spooled file conversion is

complete. IP60 measurements made with PWC=YES were also made. Results are compared to the PWC=NO results in Table 30 on page 324.

Table 30. IP60 performance with PSF/400 V4R2 (AS400 Model 510/2144): Print While Convert=NO

Case	No. of pages	Page times		Conversion		Printing		Processor Time		
		(mins:secs)		Rate	Util	Rate	Util	per page (msec)		
		First	Last	(PPM)	(%)	(PPM)	(%)	Cvt	Prt	Tot
INVPRE(s)	300	:26	5:25	5,488	47	60	2	5.1	17.5	22.6
INVNEW2	300	:35	6:03	4,478	53	52	1	7.0	11.1	18.1
INVNEW2A	300	:31	5:29	5,028	43	60	1	5.2	11.3	16.4
INVNEW3	300	:32	6:30	4,255	53	50	1	7.5	17.1	24.6
INVNEW3A	300	:35	5:33	4,255	39	60	1	5.4	14.0	19.4
INVSCS	300	:38	1:04	4,216	54	28	1	7.6	25.2	32.8
INVPDEF	78	:32	1:48	1,286	30	60	1	14.0	11.5	25.5
SHLFLB(s)	300	:52	5:50	892	98	60	1	65.8	9.9	75.7
SHLFLBA	300	1:04	6:05	861	93	59	.2	64.5	2.6	67.1
SCS(s)	240	:27	4:26	2,780	69	60	.2	14.9	1.7	16.6
SCS-PT(s)	240	:28	4:47	4,260	77	55	.1	10.8	1.2	12.0
SCS-PDEF(s)	240	:33	4:32	4,528	37	60	.3	4.9	3.4	8.3
TXT08K	320	:31	5:49	-	-	60	na	4.3	3.3	7.6
TXT32K	320	:38	5:56	2,365'	40	60	1	10.2	7.5	17.7
TXTCMLIM	320	:42	6:00	1,596	49	60	2	18.3	25.0	43.4
STMTSHAD	320	:45	6:03	2,520	71	60	1	17.0	14.6	31.6
RAST24	300	1:17	6:15	641	42	60	2	39.2	24.6	63.8
RAST50	300	1:39	6:37	300	39	60	4	78.0	45.4	123.4
CHKSG410	300	:51	5:49	1,243	76	60	1	36.8	6.5	43.3
G479BO52	300	:59	5:57	874	46	60	1	31.6	15.0	46.6

Case	No. of pages	Page times		Conversion		Printing		Processor Time		
		(mins:secs)		Rate	Util	Rate	Util	per page (msec)		
		First	Last	(PPM)	(%)	(PPM)	(%)	Cvt	Prt	Tot
Notes:										
(s) Indicates simplex printing.										
(msec) Stands for milliseconds or thousandths of a second.										
<ul style="list-style-type: none"> • No. Pages: The total number of pages printed for the job. For duplex jobs, this is twice the number of sheets produced by the printer. • Page Times: The number of minutes and seconds (from the time the job was released from the spool) until the first and last pages were printed. • Conversion Rate: The rate in pages per minute at which the spooled file was converted prior to printing. • Conversion Util: The percent of the time the AS/400 processor was busy while the spooled file was being converted. When no other work is using the processor (as in these measurements), the spooled file conversion process uses as much processor time as it can and converts at a high rate. When other processors are running, as they normally are, utilization for conversion is higher and the conversion rate is lower. • Printing Rate: The rate in pages per minute at which pages are printed. • Printing Util: The percent of the time the AS/400 processor is busy while the spooled file is being printed. For a given job, printing utilization is approximately proportional to the printing rate. • Processor Time per Page: The milliseconds of time during which the processor was busy for each page converted, printed, and totalled. This number is independent of the rate at which pages are being printed. 										

F.4.3 PSF/400 V4R2 with IP4000

The IP4000 printer is a continuous-forms printer that can be used in either 240 dpi or 300 dpi resolution. For this study, it was used in 240 dpi resolution. Its maximum printing speed is 708 PPM when printing two-up duplex on letter sized pages. All jobs were printed on the IP4000 in two-up duplex. The IP4000 measurements shown in Table 31 were made with PWC=NO, which causes printing to wait until the spooled file conversion is complete.

Table 31. IP4000 performance with PSF/400 V4R2 (AS/400 Model 510/2144): Print While Convert=NO

Case	No. of pages	Page times		Conversion		Printing		Processor Time		
		(mins:secs)		Rate	Util	Rate	Util	per page (msec)		
		First	Last	(PPM)	(%)	(PPM)	(%)	Cvt	Prt	Tot
INVPRE	3520	:25	5:23	12,857	83	708	25	3.9	21.8	25.6
INVNEW2A	3520	:20	5:18	15,589	81	708	14	3.1	12.5	15.6
INVNEW3A	3520	:25	5:27	12,512	75	708	21	3.6	17.9	21.5
INVPDEFA	804	:10	1:17	9,805	46	708	7	2.8	6.4	9.2
SHLFLBA	3480	4:03	8:58	880	97	708	3	66.2	2.2	68.4
SCSA	3520	:25	5:23	10,353	8	708	1	5.1	0.9	6.1
SCS-PTA	3520	:18	5:16	15,808	9	708	.4	3.5	0.4	3.8
TXT08K	3520	:30	5:28	8,322	58	708	4	4.2	3.3	7.5
TXT32K	2112	:54	5:51	2,715	45	478	4	9.9	5.3	15.3
TXTCMLIM	3520	1:59	9:47	1,880	54	389	17	17.4	23.2	40.5

Case	No. of pages	Page times		Conversion		Printing		Processor Time		
		(mins:secs)		Rate	Util	Rate	Util	per page (msec)		
		First	Last	(PPM)	(%)	(PPM)	(%)	Cvt	Prt	Tot
STMTSHAD	3520	1:06	7:36	3,621	92	538	15	15.3	17.3	32.6
RAST24	1200	2:00	5:59	638	43	288	11	40.6	21.6	62.2
CHKSG410	2300	1:43	5:36	1,427	79	589	6	33.3	6.1	39.5
G479BO52	2000	2:12	8:48	962	50	305	7	31.3	13.3	44.7

Notes:

(msec) Stands for milliseconds or thousandths of a second.

- **No. Pages:** The total number of pages printed for the job. For two-up duplex jobs, this is four times the number of sheets produced by the printer.
- **Page Times:** The number of minutes and seconds (from the time the job was released from the spool) until the first and last pages were printed.
- **Conversion Rate:** The rate in pages per minute at which the spooled file was converted prior to printing.
- **Conversion Util:** The percent of the time the AS/400 processor is busy while the spooled file is being converted. When no other work is using the processor (as in these measurements), the spooled file conversion process uses as much processor time as it can and converts at a high rate. When other processors are running, as they normally are, utilization for conversion is higher and the conversion rate is lower.
- **Printing Rate:** The rate in pages per minute at which pages are printed.
- **Printing Util:** The percent of the time the AS/400 processor is busy while the spooled file is being printed. For a given job, printing utilization is approximately proportional to the printing rate.
- **Processor Time per Page:** The milliseconds of time during which the processor is busy for each page converted, printed, and totalled. This number is independent of the rate at which pages are being printed.

F.4.4 Comparison: Printing rates using PSF/400 V4R2 on Model 510/2144

The printing rates (with PWC=NO) for NP24, IP60, and IP4000 are compared in Table 32. Explanations of less-than-maximum speed results are included after the table.

These rates were achieved when the AS/400 system was doing nothing else, when the Token-Ring was not shared with any other devices, and when the spooled file conversion had already completed. Some of these rates might not be achieved under other circumstances, especially with the high-speed IP4000.

Some jobs were not measured on all three printers because of functional differences.

Table 32. Printing rates (PPM) for NP24, IP60, and IP400: Print While Convert=NO

Case	NP24	IP60	IP4000
INVPRE	(s)24	(s)60	708
INVNEW2	19	52 ⁵	-
INVNEW2A	-	60	708
INVNEW3	19	50 ⁵	-
INVNEW3A	-	60	708
INVSCS	13 ⁶	28 ⁶	-

Case	NP24	IP60	IP4000
INVPDEF	19	60	-
INVPDEFA	-	-	708
SHLFLB	(s)24	(s)60	-
SHLFLBA	-	59 ⁵	708
SCS	(s)24	(s)60	-
SCSA	-	-	708
SCS-PT	(s)24	(s)55 ⁵	-
SCS-PTA	-	-	708
SCS-PDEF	(s)24	(s)60	-
TXT08K-HPT	19	-	-
CMLIM-HPT	19	-	-
INVN2-HPT	19	-	-
TXT08K	19	60	708
TXT32K	19	60	478 ¹
TXTCMLIM	19	60	389 ³
STMTSHAD	14 ¹	60	538 ³
RAST24	19	60	288 ²
RAST50	8 ¹	60	-
CHKSG410	19	60	589 ²
G479BO52	6 ¹	60	305 ²

(s) Printing in simplex.

1. Limited by printer control unit capability. That is, this model of the IP4000 is not capable of printing this case at maximum speed of 708 PPM.
2. Limited by Token-Ring attachments. The theoretical limitation of the 16 Mb per second Token-Ring is 2 MB per second and the practical data rate limitation of TCP/IP and the Token-Ring, including the effects of this printer's Token-Ring adapter, is below that. For example, printing the RAST24 case at 708 PPM requires an average sustained data rate to the printer of slightly more than 2 MB per second because of the amount of data contained in each page.
3. Limited by PSF/400 processing of downloaded fonts while printing. This job prints at a rated speed if printer-resident fonts are used. A PSF/400 improvement not yet available also eliminates this limitation.
4. Limited by PSF/400 processing of downloaded fonts. This job prints faster but not at a maximum speed (because of printer control unit limitations) if printer-resident fonts are used. A PSF/400 improvement not available in V4R2 also eliminates this limitation.
5. Limited by mechanical problems in the IP60, which prevented paper from being provided for each print cycle. The IP60 is capable of printing this job at 60 PPM.
6. Limited by switching between simplex and duplex.

F.4.5 Comparison of processor requirements

Processor requirements for printing are summarized in Table 33. The amounts of processor time used to convert and print each page have been calculated from the times for the entire file, and then added together to show the total processor time needed to convert and print each page.

These times are shown in milliseconds of processor time per page. Processor time to convert these cases is generally larger than the processor time to print, although there are exceptions. Those applications that use relatively large amounts of processor time per page to convert may convert slowly (maybe more slowly than the maximum speed of the printer), especially if the AS/400 processor is less powerful or is heavily used for other purposes than printing. The throughput of some applications can be limited by how fast the spooled file conversion can run, especially with high-speed or large numbers of printers, or with small or heavily loaded AS/400 systems. This can cause jobs to print more slowly than expected and continuous forms printers to pause.

Table 33. Processor usage for printing in milliseconds per page: Print with Convert=NO

Case	AS/400 Processor milliseconds per page								
	Model 519/2144 (measured)						Model 640/2237**		
	IP60			IP4000			IP400		
	Cvt	Prt	Tot	Cvt	Prt	Tot	Cvt	Prt	Tot
INVPRE	5.1	17.5	22.6	3.9	21.8	25.6	1.4	7.6	8.9
INVNEW2	7.0	11.1	18.1	-	-	-	-	-	-
INVNEW2A	5.2	11.3	16.4	3.1	12.5	15.6	1.1	4.4	5.5
INVNEW3	7.5	17.1	24.6	-	-	-	-	-	-
INVNEW3A	5.4	14.0	19.4	3.6	17.9	21.5	1.3	6.3	7.5
INVSCS	7.6	25.2	32.8	-	-	-	-	-	-
INVPDEF	14.0	11.5	25.5	-	-	-	-	-	-
INVPDEFA	-	-	-	2.8	6.4	9.2	1.0	2.2	3.2
SHLFLB	65.8	9.9	75.7	-	-	-	-	-	-
SHLFLBA	64.5	2.6	67.1	66.2	2.2	68.4	23.1	0.8	23.9
SCS	14.9	1.7	16.6	-	-	-	-	-	-
SCSA	-	-	-	5.1	0.9	6.1	1.8	0.3	2.1
SCS-PT	10.8	1.2	12.0	-	-	-	-	-	-
SCS-PTA	-	-	0	3.5	0.4	3.8	1.2	0.1	1.3
SCS-PDEF	4.9	3.4	8.3	-	-	-	-	-	-
TXT08K-HPT	-	-	-	-	-	-	-	-	-
CMLIM-HPT	-	-	-	-	-	-	-	-	-
INVN2-HPT	-	-	-	-	-	-	-	-	-
TXT08K	4.3	3.3	7.6	4.2	3.3	7.5	1.5	1.2	2.6

Case	AS/400 Processor milliseconds per page								
	Model 519/2144 (measured)						Model 640/2237**		
	IP60			IP4000			IP400		
	Cvt	Prt	Tot	Cvt	Prt	Tot	Cvt	Prt	Tot
TXT32K	10.2	7.5	17.7	9.9	5.3	15.3	3.5	1.9	5.3
TXTCMLIM	18.3	25.0	43.4	17.4	23.2	40.5	6.1	8.1	14.2
STMTSHAD	17.0	14.6	31.6	15.3	17.3	32.6	5.3	6.0	11.4
RAST24	39.2	24.6	63.8	40.6	21.6	62.2	14.2	7.5	21.7
RAST50	78.0	45.4	123.4	-	-	-	-	-	-
CHKSG410	36.8	6.5	43.3	33.3	6.1	39.5	11.6	2.1	13.8
G479BO52	31.6	15.0	46.6	31.3	13.3	44.7	10.9	4.6	15.6
<p>* These particular HPT jobs, which are measured using the default customization table (this includes the “mapping” option), require large amounts of processor time to print. This is required for conversion from AFPDS to PCL to allow printing on PCL printers (on the NP24 in PCL mode, in this case). For comparison, see the processor time per page for the same jobs printed directly to the NP24 in IPDS mode (TXT08K, TXTCMLIM, and INVNEW2).</p> <p>** The processor times per page for the AS/400 Model 640/2237 are not measured results. They were extrapolated from the Model 510/2144 results using the V4R1 CPW ratings for the two models (111.5 and 319.0) to demonstrate the effect of using a more powerful processor. Extrapolations to less powerful processors result in proportionally larger processor milliseconds per page, according to the ratio of their CPW ratings and the Model 510/2144 CPW rating.</p>									

The SHLFLB case, consisting of 30 barcodes per page and nothing else, uses a significant amount of processor time. Differences in processor time between INVNEW2 and INVNEW2A, and between INVNEW3 and INVNEW3A, which differ mostly by inclusion of less than one barcode per page, also support the conclusion that applications that use BCOCA barcodes heavily require significant processor time and may not convert at high-speed printer rates.

Image-intensive applications, such as RAST24, RAST50, and CHKSG410, also use significant amounts of processor time per page, mostly due to the amounts of data that must be processed. These applications may also convert more slowly than the maximum speeds of some printers. Using image compression can minimize this effect.

F.4.6 Predictions of processor utilizations at printing speeds

Calculated processor utilizations for printing at various aggregate rates on two different AS/400 models are shown in Table 34 on page 330. Model 510/2144 has a V4R1 CPW rating of 111.5, and Model 640/2238 (a 2-way system) has a V4R1 CPW rating of 583.3 (about 5.2 times as powerful). Using a more powerful system has the effect of reducing the average processor utilization needed to print a particular file at a certain rate by the difference in processing power, in this case, approximated by the difference in CPW ratings of the two AS/400 models. The utilizations represent the average processor utilization needed to convert and

print each application at the maximum speeds of the three printers. As you can see from previous tables, not all of these applications print on all three printers (for example, the HPT ones), and some that print on a particular printer do not print at maximum speed. Furthermore, some that printed at maximum speed might not on different AS/400 configurations or under different circumstances.

The utilizations represent the theoretical processor loads if each application is printed at the speeds shown. Where predicted utilizations are high, especially when over 100%, the application requires more processor power than the AS/400 model shown to print at the desired speed, even with no other loads on the system.

Note that this does not guarantee the ability to convert and print these applications at the indicated speeds (on these AS/400 configurations or any other).

Table 34. Predicted total processor utilization for printing, in percent: Print While Convert=NO

Case	Calculated AS/400 processor utilization					
	Model 510/2144			Model 640/2238		
	60PPM	480PPM	960PPM	60PPM	480PPM	960PPM
INVPRE	2.3	18.1	36.2	0.4	3.5	6.9
INVNEW2	1.8	14.8	29.0	0.3	2.8	5.5
INVNEW2A	1.6	13.1	26.3	0.3	2.5	5.0
INVNEW3	2.5	19.7	39.3	0.5	3.8	7.5
INVNEW3A	1.9	15.6	31.1	0.4	3.0	5.9
INVSCS	3.3	26.3	52.5	0.6	5.0	10.0
INVPDEF	2.6	20.4	40.8	0.5	3.9	7.8
INVPDEFA	0.9	7.4	14.8	0.2	1.4	2.8
SHLFLB	7.6	60.6	121.1	1.4	11.6	23.2
SHLFLBA	6.7	53.7	107.4	1.3	10.3	20.5
SCS	1.7	13.3	26.6	0.3	2.5	5.1
SCSA	0.6	4.9	9.8	0.1	0.9	1.9
SCS-PT	1.2	9.7	19.3	0.2	1.8	3.7
SCS-PTA	0.4	3.1	6.1	0.1	0.6	1.2
SCS-PDEF	0.8	6.7	13.3	0.2	1.3	2.5
TXT08K-HPT	12.3	98.7	197.4	2.4	18.9	37.7
CMLIM-HPT	31.0	247.9	495.7	5.9	47.4	94.8
INVN2-HPT	39.9	319.2	638.4	7.6	61.0	122.0
TXT08K	0.8	6.4	12.2	0.1	1.2	2.3
TXT32K	1.8	14.4	28.3	0.3	2.7	5.4
TXTCMLIM	4.3	34.4	69.4	0.8	6.6	13.3

Case	Calculated AS/400 processor utilization					
	Model 510/2144			Model 640/2238		
	60PPM	480PPM	960PPM	60PPM	480PPM	960PPM
STMTSHAD	3.2	25.6	50.6	0.6	4.8	9.7
RAST24	6.4	51.2	102.1	1.2	9.8	19.5
RAST50	12.3	98.4	197.4	2.4	18.9	37.7
CHKSG410	4.3	34.4	69.3	0.8	6.6	13.2
G479BO52	4.7	37.6	74.6	0.9	7.1	14.3

F.4.7 Print While Convert (PWC)=Yes compared to PWC=NO

Most PSF/400 V4R2 measurements were done with PWC=NO for repeatability and control of the experiments, but PSF/400 Spool File Conversion is normally done while printing (PWC=YES). Measurements were made to compare PWC=YES performance to PWC=NO performance using the IP60 printer.

Selected results are compared in Table 35. The general differences are:

- Time to first page is shorter with PWC=YES. This is no surprise, since printing can start before the entire file is converted.
- Conversion rates are generally a little slower with PWC=YES, but not always in these measurements (this may reflect on the accuracy of the measurements). This might also be expected, since the conversion and printing processes are competing for processor and other resources. However, this difference is not large in this dedicated environment where other demands do not exist.

Other consistent differences are not obvious. The total processor time for converting and printing is generally about the same for both cases.

Table 35. Print While Convert (PWC) YES compared to PWC NO: AS/400 Model 510/2144

Case	First page times		Conversion		Average		Processor time	
	(mins:secs)		Rates (PPM)		Utilizations		per Page	
	No	Yes	No	Yes	No	Yes	No	Yes
INVPRE	:26	:27	5,488	3,724	2	2	22.6	20.3
INVNEW2	:35	:32	4,478	4,157	2	2	18.1	17.2
INVNEW3	:32	:38	4,255	3,947	2	2	24.6	19.9
INVSCS	:38	:42	4,216	3,871	2	1	32.8	30.1
INVPDEF	:32	:41	1,286	1,333	2	2	25.5	25.1
SHLFLB	:52	:28	892	799	7	7	75.7	75.2
SCS	:27	:27	2,780	2,764	2	2	16.6	19.9
SCS-PT	:28	:22	4,260	4,022	1	1	12.0	12.1
SCS-PDEF	:33	:30	4,528	4,103	1	1	8.3	8.3

Case	First page times		Conversion		Average		Processor time	
	(mins:secs)		Rates (PPM)		Utilizations		per Page	
	No	Yes	No	Yes	No	Yes	No	Yes
TXT08K	:31	:33	-	5,439	-	1	7.6	7.6
TXT32K	:38	:30	2,365	2,308	2	2	17.7	17.7
TXTCMLIM	:42	:37	1,596	1,479	4	4	43.4	42.5
STMTSHAD	:45	:37	2,520	2,212	3	3	31.6	28.1
RAST24	1:17	:36	641	605	6	6	63.8	59.5
RAST50	1:39	:35	300	293	11	14	123.4	25.6
CHKSG410	:51	:37	1,243	1,266	4	4	43.3	40.0
G479BO52	:59	:32	874	856	4	5	46.6	46.3

F.5 Application of results

Some practical conclusions and observations can be made from this information:

- Most of the printing applications used in these measurements, particularly the native AS/400 applications, are practical on at least one high speed printer such as the IP4000, given a powerful enough AS/400 system and spare capacity.
- It is possible to determine the amount of processor power needed to print at a certain rate (for example, on two IP60 printers at 120 PPM) using the information in this appendix. Where processors other than the Model 510/2144 are involved, CPW ratings are used to adjust the data to get an approximate answer.

Where large numbers of printers are involved, and where other key applications place heavy requirements on the AS/400 system, you must use more care with this approach.

- Characteristics of applications have large effects on throughput, on the AS/400 power required to achieve it, on the printer attachment bandwidth needed, and on a printer's ability to print at its maximum rate.

Some applications, then, may be too demanding to print on high speed or large numbers of printers, using slow or heavily loaded AS/400 systems.

The processor power needed to convert and print at a given rate depends almost entirely on application characteristics, and not on the printer. In particular, these applications may require more of an AS/400 processor than others, and may be more likely to print at less than the maximum speeds of some printers.

- Those using significant numbers of barcodes implemented in BCOCA. The spooled file conversion may use a lot of processor time and run at a slow rate (PPM). However, BCOCA applications implemented using Page Definition support in Page Printer Formatting Aid (PPFA) can be much more efficient than the applications used here, because PPFA produces BCOCA objects that can require significantly less processing by PSF/400.

- Those using significant amounts of image data, especially if it is not compressed. The spooled file conversion may use a lot of processor time and run at a slow rate, and attachment limitations may prevent data from being delivered to a printer at the rate needed to print at its maximum speed.
- Those using host print transform to print an AFPDS spooled file on a PCL printer.
- Those using downloaded fonts on every page with a printer that supports both downloaded raster and downloaded outline fonts (that is, all “AFCCU” printers such as the IP60 and IP4000, or any other printer that supports both the LF1 and LF3 font subsets). Applications that use printer-resident fonts do not need this additional processing, and a planned improvement to PSF/400 will reduce processor use for applications that download fonts.
- The spooled file conversion may use much more processor resource than printing. This can limit printing throughput with combinations of high speed or large numbers of printers, and with slow or heavily loaded AS/400 systems.
- The data in this appendix can also be adjusted to approximate the effects of multiple printers, other printers, or other AS/400 models, for example:
 - An application, such as INVPDEFA, is expected to need about 11% of a Model 510/2144 AS/400 system to print at 708 PPM. For the same application, two 708 PPM printers are expected to need about 22% of the processor.
 - An application, such as the SHLFLB application, which uses about 90% of the system to print at 708 PPM, is not feasible for two 708 PPM printers (it is not really feasible for one unless almost the entire processor is available for printing) on a Model 510/2144 AS/400 system.
 - An application, such as the SHLFLB application, if printed on an AS/400 Model 650/2240 (V4R1 CPW rating of 1,794.0), needs only about 5% utilization of the eight processors in that model instead of almost 90% utilization on the Model 510/2144 when printing on a single 708 PPM IP4000.

F.6 Sample output

Figure 237 on page 334 through Figure 252 on page 341 show examples of the output from the test cases described in this appendix. The quality of these illustrations is not representative of the high quality output produced from PSF/400, but is a function of the processes used to produce this publication.

Super Sun Seeds
A Growth Company

UNIONED FARMING CORP
PERFORMANCE BOULEVARD
MILWAUKEE, WI
45788-2837

SAGE

Customer Number: 100 Order Number: 91320 Order Date: 12/19/97 Order Total: 57139.97

Ship Via: **EMV** Ship Date: 12/19/97 Order Ref: **00** Customer: **YOUR FUTURE REP**

QTY	UNIT	ITEM #	DESCRIPTION	PRICE	AMOUNT
1	CT	02070300	HYUN ALTIMOR VETERANION	1.01	1.01
1	PK	01110517	SPARTAN SEEDS	2.89	2.89
8	PK	04588700	NORTHERN LITE BLUE SPRUCE	875.50	7,004.00
14	PK	11055004	SUN GREEN SEEDS	2.50	35.00
12	CT	11055011	LARGO RED SEEDS	802.25	10,027.00
26	PK	11057318	SEALS BANTON SEEDS	.38	9.88
2	PK	11057322	AFRICA WILSON SEEDS	2.50	5.00
1	PK	18910100	SEEDS	139.00	139.00
1	PK	18740510	SEEDS	2.50	25.00
6	PK	18579310	SEEDS	69.00	414.00
2	PK	58142335	SEEDS	7.85	15.70
8	PK	08412384	SEEDS	888.00	7,104.00
1	PK	84123223	SEEDS	.97	.97
2	PK	93335744	SEEDS	.20	0.40
1	PK	98412306	SEEDS	2.50	25.00
1	PK	98541100	SEEDS	109.90	109.90

Total Due: **57,139.97**

THANK YOU
Because you have ordered over \$50 of seeds this year, we will receive a 1% discount.

This invoice is being printed using TRILAF 4.000000

Payment to due by: 12/19/97 Amount Due to: Super Sun Seeds 57,139.97

UNIONED FARMING CORP
PERFORMANCE BOULEVARD
MILWAUKEE, WI
45788-2837

Page 1

Figure 237. INVPRE

Super Sun Seeds
A Growth Company

UNIONED FARMING CORP
PERFORMANCE BOULEVARD
MILWAUKEE, WI
45788-2837

SAGE

Customer Number: 100 Order Number: 91320 Order Date: 12/19/97 Order Total: 57139.97

Ship Via: **EMV** Ship Date: 12/19/97 Order Ref: **00** Customer: **YOUR FUTURE REP**

QTY	UNIT	ITEM #	DESCRIPTION	PRICE	AMOUNT
1	CT	02070300	HYUN ALTIMOR VETERANION	1.01	1.01
1	PK	01110517	SPARTAN SEEDS	2.89	2.89
8	PK	04588700	NORTHERN LITE BLUE SPRUCE	875.50	7,004.00
14	PK	11055004	SUN GREEN SEEDS	2.50	35.00
12	CT	11055011	LARGO RED SEEDS	802.25	10,027.00
26	PK	11057318	SEALS BANTON SEEDS	.38	9.88
2	PK	11057322	AFRICA WILSON SEEDS	2.50	5.00
1	PK	18910100	SEEDS	139.00	139.00
1	PK	18740510	SEEDS	2.50	25.00
6	PK	18579310	SEEDS	69.00	414.00
2	PK	58142335	SEEDS	7.85	15.70
8	PK	08412384	SEEDS	888.00	7,104.00
1	PK	84123223	SEEDS	.97	.97
2	PK	93335744	SEEDS	.20	0.40
1	PK	98412306	SEEDS	2.50	25.00
1	PK	98541100	SEEDS	109.90	109.90

Total Due: **57,139.97**

THANK YOU
Because you have ordered over \$50 of seeds this year, we will receive a 1% discount.

This invoice is being printed using TRILAF 4.000000

Payment to due by: 12/19/97 Amount Due to: Super Sun Seeds 57,139.97

UNIONED FARMING CORP
PERFORMANCE BOULEVARD
MILWAUKEE, WI
45788-2837

Customer Copy Page 1

Figure 238. INVNEW2 and INVNEW3



Super Sun Seeds
 A Growth Company

IMPROVED PRINTING CORP
 PERFORMANCE BOULEVARD
 PAINTEWILLE, IL
 60 45782-2637

--- Bill To ---

Company # 100 Division # 31300 Invoice Date 07/27/98 Invoice To 5/12/98
 Order # 8887 WAX Original Date 2/12/98 Invoice # 03 Customer 5045 PUNTER REP

QUO	LOT	ITEM #	DESCRIPTION	QUAN	UNIT PRICE	TOTAL
1	SK	0112043	SPARTAN SEEDS	2.38		2.38
9	PK	0458870	NORTHERN LINE BLUE SERVICE	858.32		7,724.08
14	SK	1102504	SOY BEAN SEEDS	2.38		20.00
13	CT	1102501	1480 RED SEEDS	852.25		10,706.76
26	PK	1102502	PALM HAYAT SEEDS	.38		9.88
5	SK	1107893	ARLON HAYAT SEEDS	2.38		11.78
7	PK	1897520	HEAVY OAK	129.09		129.09
13	SK	1724510	HORN BREASTING SEEDS	1.20		19.60
1	PK	1557841	SEED SAVORITY SEEDS	58.00		170.00
2	PK	8513213	SOY BEAN	9.00		19.00
80	PK	8541228	SEED SAVORITY	208.79		71,178.20
1	PK	8481225	CAROL SPRING CORN SEED	.97		.97
2	SK	9531224	TITANIC CORN SEEDS	2.38		2.38
1	SK	9481206	GRAND HAYAT SEEDS	2.38		25.38
5	SK	9481220	TROUS OIL SEEDS	109.90		549.80
1	PK	0202010	HIGH ALPINE WATERMELON	.01		1.01

Thank You
 Because you have ordered
 over \$500 of seeds this
 year, on your next seed
 order you will receive
 a 10% discount.

This invoice is designed using UELAFF Utilities® Total Due: \$97,852.27

Payment is due by: 8/3/98 Amount Due is: \$97,852.27

IMPROVED PRINTING CORP
 PERFORMANCE BOULEVARD
 PAINTEWILLE, IL
 60 45782-2637

Customer Copy Page 1

Figure 239. INVNEW2A and INVNEW3A



Super Sun Seeds
 A Growth Company

IMPROVED PRINTING CORP
 PERFORMANCE BOULEVARD
 PAINTEWILLE, IL
 60 45782-2637

--- Bill To ---

Company # 100 Division # 31300 Invoice Date 10/21/97 Invoice To 11/21/97
 Order # 8888 WAX Original Date 10/21/97 Invoice # 03 Customer 5045 PUNTER REP

QUO	LOT	ITEM #	DESCRIPTION	QUAN	UNIT PRICE	TOTAL
1	CT	0202010	HIGH ALPINE WATERMELON	1.01		1.01
1	PK	0112043	SPARTAN SEEDS	2.38		2.38
9	PK	0458870	NORTHERN LINE BLUE SERVICE	858.32		7,724.08
14	SK	1102504	SOY BEAN SEEDS	2.38		30.00
13	CT	1102501	1480 RED SEEDS	852.25		10,706.76
26	PK	1102502	PALM HAYAT SEEDS	.38		9.88
5	SK	1107893	ARLON HAYAT SEEDS	2.38		11.78
7	PK	1897520	HEAVY OAK	129.09		129.09
58	SK	3214510	HORN BREASTING SEEDS	1.20		30.60
8	SK	4581225	SEED SAVORITY SEEDS	60.00		300.00
2	PK	8541228	SEED SAVORITY	7.00		25.00
80	PK	8541228	SEED SAVORITY	208.79		71,178.20
1	PK	8481225	CAROL SPRING CORN SEED	.97		.97
1	PK	9531224	TITANIC CORN SEEDS	1.20		2.38
1	SK	9481206	GRAND HAYAT SEEDS	2.38		25.38
5	SK	9481220	TROUS OIL SEEDS	109.90		549.80

Thank You
 Because you have ordered
 over \$500 of seeds this
 year, on your next seed
 order you will receive
 a 10% discount.

This invoice is designed using UELAFF Utilities® Total Due: \$97,852.27

Payment is due by: 11/21/97 Amount Due is: \$97,852.27

IMPROVED PRINTING CORP
 PERFORMANCE BOULEVARD
 PAINTEWILLE, IL
 60 45782-2637

Customer Copy Page 1

Figure 240. INVSCS



Super Sun Seeds
A Carolina Company

201 CUST Invoice
Durham, NC 27709 (919) 286-2100
Fax: 919-286-2100

DEST COMPANY
DEST ORDER
DEST CITY
SN 12245-4720

SANS

Customer Number: JRG Invoice Number: 51303 Invoice Date: 11/26/95 Order Date: 11/23/95

Item # DEST Pkg In-stock Item UOM QTY Unit Price Net Amt Tax Total

1	OT	80800000	BLUE ALPINE WATERMELON	1.00		1.00		1.00
2	TS	01100011	SPEARHEAD CORN	2.25		2.25		2.25
9	DE	04240010	BRONZE LEAF BLUE SPINACH	826.81		7,124.89		7,124.89
12	DL	11000004	FRESH CORN SEEDS	3.00		30.00		30.00
13	CP	11000011	CARROT SEED SEEDS	692.22		10,700.78		10,700.78
26	WE	11000010	SHRIMP HERRING SEEDS	1.00		1.00		1.00
5	DE	11000010	ARIZONA CHILE PEPPERS	3.00		31.75		31.75
1	PE	13010000	HEAVY PAL	127.00		129.00		129.00
33	DL	23700000	WAX BEAN SEEDS	1.00		30.00		30.00
32	DL	23700010	WAX BEAN SEEDS	1.00		30.00		30.00
4	KA	40700010	SEED SENSITIVE SEEDS	50.00		100.00		100.00
7	DK	04010010	WAX BEAN	7.00		20.00		20.00
8	PE	04010010	WAX BEAN	650.00		71,100.00		71,100.00
1	PE	04010010	CANTON STREET TOMATO SEED	1.00		1.00		1.00
2	DE	04010010	100% PLEASANT SEEDS	1.00		2.50		2.50
11	DK	04010010	ULACIN BEAUTY SEEDS	1.00		25.00		25.00
2	KA	04010010	SEED SENSITIVE SEEDS	100.00		540.00		540.00

Seed

Thank you for your order. Please pay here within 30 days of invoice date. If you have any questions, please call our toll-free number 1-800-286-2100.

This invoice is subject to our 1995 Terms & Conditions Total Due \$93,691.50

Amount Due by: 12/26/95 Amount Due is: \$93,691.50

Page

01CUST

Figure 241. INVPDEF and INVPDEF A

HIGH ALTITUDE WATERMELON 1-21-2	HIGH ALTITUDE WATERMELON 1-21-2	HIGH ALTITUDE WATERMELON 1-21-2
HIGH ALTITUDE WATERMELON 1-21-2	HIGH ALTITUDE WATERMELON 1-21-2	HIGH ALTITUDE WATERMELON 1-21-2
HIGH ALTITUDE WATERMELON 1-21-2	HIGH ALTITUDE WATERMELON 1-21-2	HIGH ALTITUDE WATERMELON 1-21-2
HIGH ALTITUDE WATERMELON 1-21-2	HIGH ALTITUDE WATERMELON 1-21-2	HIGH ALTITUDE WATERMELON 1-21-2
HIGH ALTITUDE WATERMELON 1-21-2	HIGH ALTITUDE WATERMELON 1-21-2	HIGH ALTITUDE WATERMELON 1-21-2
HIGH ALTITUDE WATERMELON 1-21-2	HIGH ALTITUDE WATERMELON 1-21-2	HIGH ALTITUDE WATERMELON 1-21-2
HIGH ALTITUDE WATERMELON 1-21-2	HIGH ALTITUDE WATERMELON 1-21-2	HIGH ALTITUDE WATERMELON 1-21-2
HIGH ALTITUDE WATERMELON 1-21-2	HIGH ALTITUDE WATERMELON 1-21-2	HIGH ALTITUDE WATERMELON 1-21-2
HIGH ALTITUDE WATERMELON 1-21-2	HIGH ALTITUDE WATERMELON 1-21-2	HIGH ALTITUDE WATERMELON 1-21-2
HIGH ALTITUDE WATERMELON 1-21-2	HIGH ALTITUDE WATERMELON 1-21-2	HIGH ALTITUDE WATERMELON 1-21-2
HIGH ALTITUDE WATERMELON 1-21-2	HIGH ALTITUDE WATERMELON 1-21-2	HIGH ALTITUDE WATERMELON 1-21-2
HIGH ALTITUDE WATERMELON 1-21-2	HIGH ALTITUDE WATERMELON 1-21-2	HIGH ALTITUDE WATERMELON 1-21-2
HIGH ALTITUDE WATERMELON 1-21-2	HIGH ALTITUDE WATERMELON 1-21-2	HIGH ALTITUDE WATERMELON 1-21-2
HIGH ALTITUDE WATERMELON 1-21-2	HIGH ALTITUDE WATERMELON 1-21-2	HIGH ALTITUDE WATERMELON 1-21-2

Figure 242. SHLFLB and SHLFLBA

H04481 94890 94048		Display Order Description - Farm		
Item#	QOH			
Object	Type	Attribute	Size	Unit
QYPR241	*FCM	CR104	5.2000	
QYPR241F	*FCM	CR1	70487	
QYPR242	*FCM	CR2	94245	
QYPR243	*FCM	CR3	372456	
QYPR244	*FCM	CR4	86436	
QYPR245	*FCM	CR5	400312	
QYPR246	*FCM	CR6	136636	
QYPR247	*FCM	CR7	28075	
QYPR248	*FCM	CR8	7328	
QYPR249	*FCM	CR9	18090	
QYPR250	*FCM	CR10	130264	
QYPR251	*FCM	CR11	200704	
QYPR252	*FCM	CR12	3785	
QYPR253	*FCM	CR13	29932	
QYPR254	*FCM	CR14	24128	
QYPR255	*FCM	CR15	24128	
QYPR256	*FCM	CR16	192267	
QYPR257	*FCM	CR17	79924	
QYPR258	*FCM	CR18	6235	
QYPR259	*FCM	CR19	24128	
QYPR260	*FCM	CR20	24128	
QYPR261	*FCM	CR21	230443	
QYPR262	*FCM	CR22	33248	
QYPR263	*FCM	CR23	40902	
QYPR264	*FCM	CR24	38004	
QYPR265	*FCM	CR25	6235	
QYPR266	*FCM	CR26	98504	
QYPR267	*FCM	CR27	5238	
QYPR268	*FCM	CR28	9604	
QYPR269	*FCM	CR29	61442	
QYPR270	*FCM	CR30	132887	
QYPR271	*FCM	CR31	38284	
QYPR272	*FCM	CR32	19285	
QYPR273	*FCM	CR33	61442	
QYPR274	*FCM	CR34	25124	
QYPR275	*FCM	CR35	192313	
QYPR276	*FCM	CR36	61442	
QYPR277	*FCM	CR37	34128	
QYPR278	*FCM	CR38	60120	
QYPR279	*FCM	CR39	48728	
QYPR280	*FCM	CR40	30728	
QYPR281	*FCM	CR41	128270	
QYPR282	*FCM	CR42	229370	
QYPR283	*FCM	CR43	18720	
QYPR284	*FCM	CR44	15424	
QYPR285	*FCM	CR45	28720	
QYPR286	*FCM	CR46	9268	
QYPR287	*FCM	CR47	6144	
QYPR288	*FCM	CR48	48020	
QYPR289	*FCM	CR49	78677	
QYPR290	*FCM	CR50	28642	
QYPR291	*FCM	CR51	28642	
QYPR292	*FCM	CR52	28642	
QYPR293	*FCM	CR53	28642	
QYPR294	*FCM	CR54	28642	
QYPR295	*FCM	CR55	28642	

Figure 243. SCS and SCS-PT

IMPROVED FENCING GOOD PERFORMANCE BOULEVARD		SAME	
COMAPBURY LLC			
DO 487892837			
LOC	31300	2/13/98	3/13/98
BMSJ Max	2/13/98	NET 33	YOUR FALHER REP
1 CT	02000300	HIGH ALTITUDE WINDMILLION	1.01
5 FR	01100919	SPARK SEEDS	2.38
12 SB	04388810	NOCTURN LIGHT BIRD SEEDS	68.30
12 SB	11000000	SOFT BROWN SEEDS	2.38
12 CT	11000011	LASSO RED SEEDS	682.22
20 FR	11000010	TARLE BROWN SEEDS	1.38
5 SB	11000002	AFRICAN DAISSY SEEDS	1.38
5 FR	14000065	HEAVY 745	129.03
33 SB	33000010	BOSS BURNING LIGHT	1.38
6 TR	25000015	SEED PURVING MIX	60.00
6 TR	35000015	TOP MIX	7.65
60 TR	60000004	SEED SORTING	682.75
6 TR	84500028	ORANGE SPRING TOMATO SEED	1.47
6 TR	48000074	STRAFFLE-ORANGE SEEDS	1.28
1 TR	48000006	TRUMP BEAUTY SEEDS	2.33
5 TR	48500020	TROCK MIXER SEEDS	109.40

Thank You
 Because you have ordered
 over 400 lb seeds this
 year, or your best seed
 order you will receive
 a 1% discount.

90,652.27

3/13/98

90,652.27

IMPROVED FENCING GOOD
 PERFORMANCE BOULEVARD
 COMAPBURY LLC
 DO 487892837

Page 1

Figure 244. SCSA and SCS-PTA

DOCUMENT PAGE TABLE: See Figure 245

FIGURE 245

This is one of several document page tables created for the IBM family of page printers. The purpose of these page tables is to characterize printer performance. Actual printer timing values are used to determine the timing of the printer. The timing of the printer is determined by the printer's internal clock. The timing of the printer is determined by the printer's internal clock. The timing of the printer is determined by the printer's internal clock.

FIGURE 246

This is one of several document page tables created for the IBM family of page printers. The purpose of these page tables is to characterize printer performance. Actual printer timing values are used to determine the timing of the printer. The timing of the printer is determined by the printer's internal clock. The timing of the printer is determined by the printer's internal clock. The timing of the printer is determined by the printer's internal clock.

Figure 245. TXT08K and TXT8K-HPT

DOCUMENT PAGE TABLE: See Figure 246

FIGURE 246

This is one of several document page tables created for the IBM family of page printers. The purpose of these page tables is to characterize printer performance. Actual printer timing values are used to determine the timing of the printer. The timing of the printer is determined by the printer's internal clock. The timing of the printer is determined by the printer's internal clock. The timing of the printer is determined by the printer's internal clock.

FIGURE 247

This is one of several document page tables created for the IBM family of page printers. The purpose of these page tables is to characterize printer performance. Actual printer timing values are used to determine the timing of the printer. The timing of the printer is determined by the printer's internal clock. The timing of the printer is determined by the printer's internal clock. The timing of the printer is determined by the printer's internal clock.

Figure 246. TXT32K

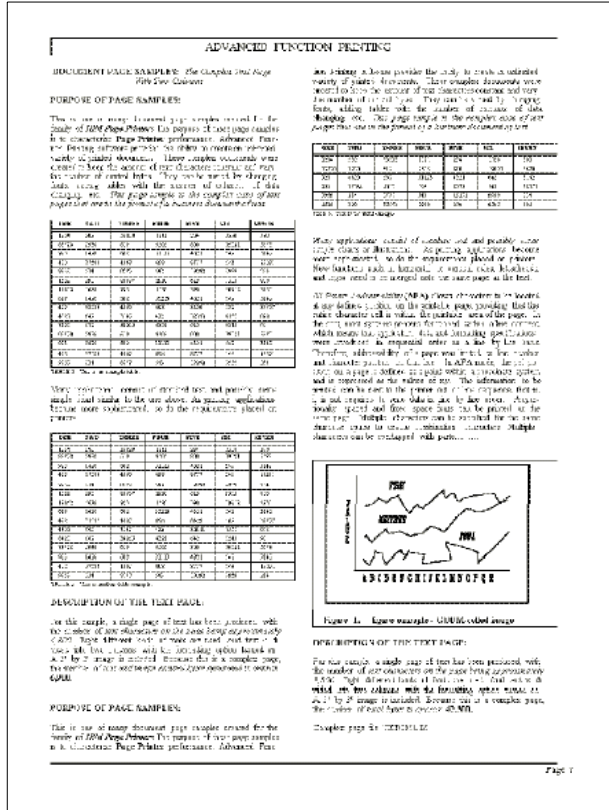

Figure 247. TXTCLIM and CMLIM-HPT

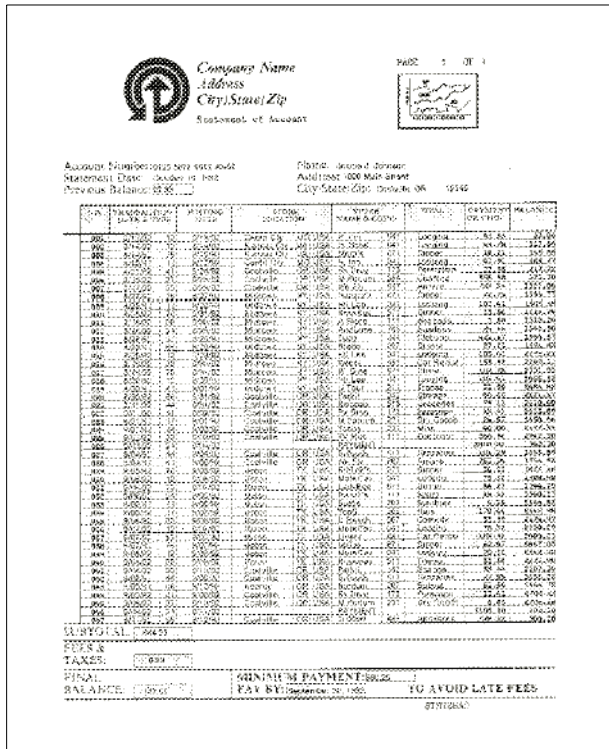

Figure 248. STMTSHAD

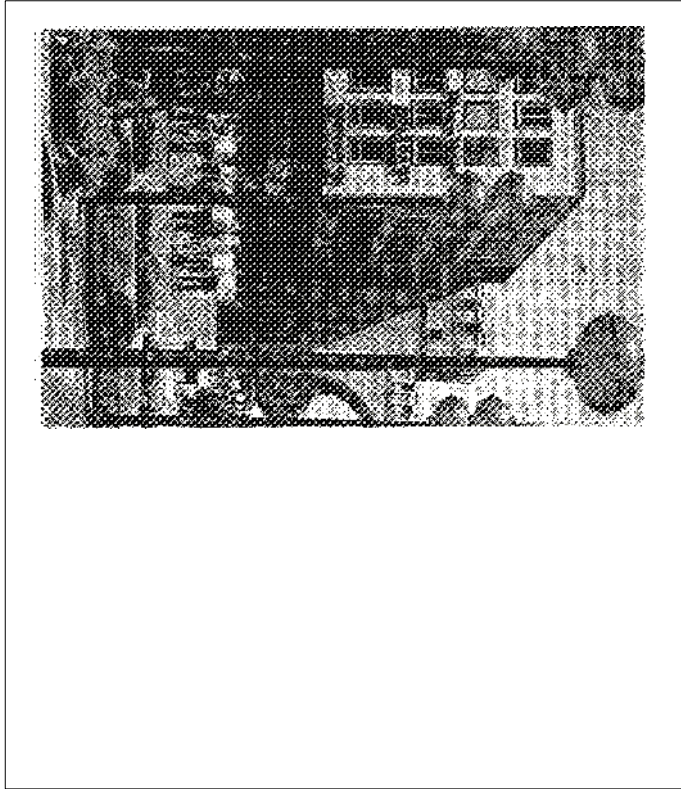

Figure 249. RAST24

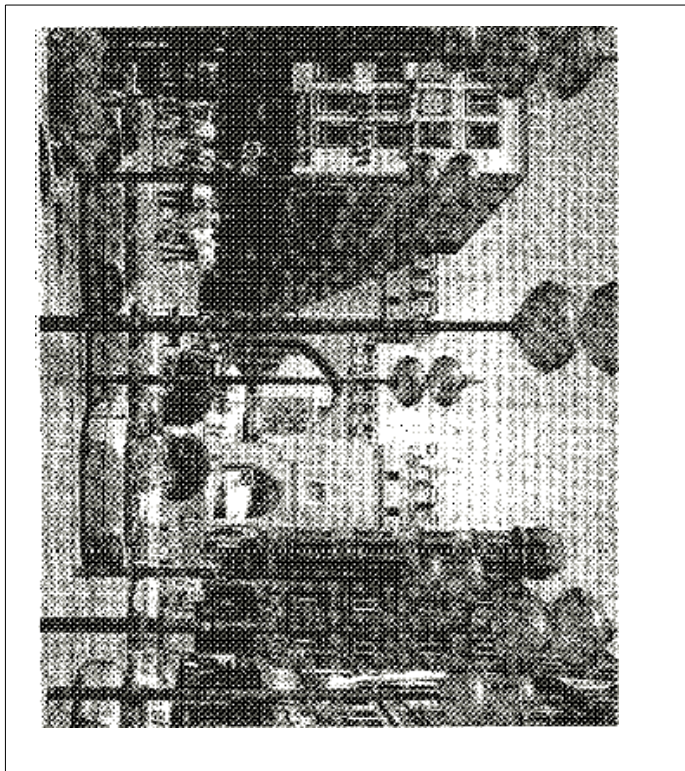

Figure 250. RAST50

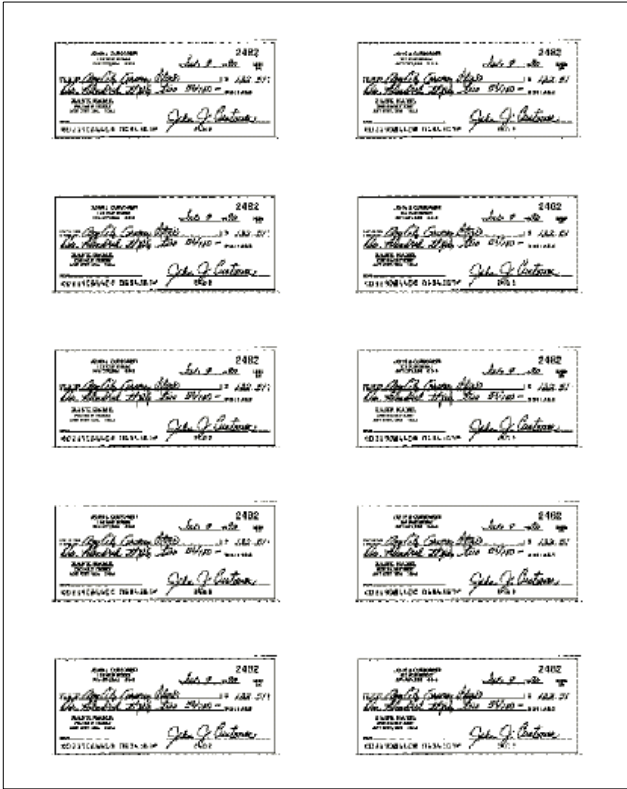

Figure 251. CHKSG410

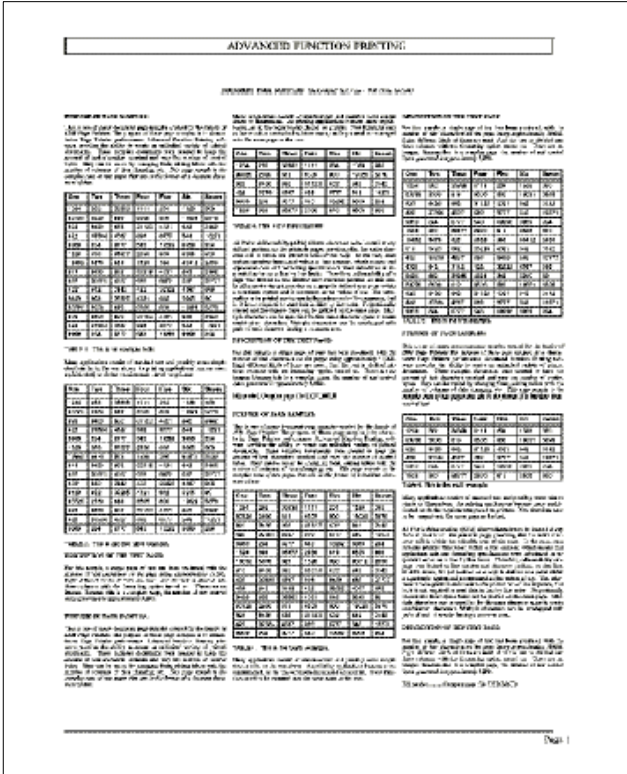

Figure 252. G479B052

Appendix G. Advanced Print Utility implementation case study

This appendix helps you implement a typical printing solution from start to finish. The project involves the conversion from pre-printed, continuous forms stationery to plain, cut-sheet, laser-printed pages. The solution is based on Advanced Function Presentation and, in particular, the Advanced Print Utility (APU) program product. In addition to printing enhanced copies of your documents, it offers the foundation for related activities, such as faxing, viewing, and archiving.

There are several useful references for using APU itself:

- Chapter 2, “Advanced Function Presentation” on page 35
- *Advanced Print Utility User’s Guide*, S544-5351
- *AS/400 Guide to AFP and PSF*, S544-5319 (Chapter 12)

In particular, you will find it useful to work through the tutorial in the *User’s Guide*. Once you have the basic skills needed, you can adopt some of the hints and tips described at the end of this chapter.

G.1 Ordering printers

This section provides details of three typical printer configurations:

- **Low End:** For printing AFP jobs and occasional PC LAN jobs
- **Departmental:** Ability to print more complex AFP and PC LAN jobs
- **Production:** Can print complex AFP production jobs plus PC LAN jobs, segregated by input and output bins

G.1.1 Low-end printer: IBM Network Printer 12

This printer configuration can accept AFP print jobs and seamlessly print PC jobs from a LAN. If required, it can be expanded with additional paper trays, a duplex unit, and more memory. See Table 36.

Table 36. IBM Network Printer 12 hardware expansions

Product/feature name	Feature code
4312 printer	Model 001, 002, 003 depending on country voltage (120, 220 or 100 V)
IPDS SIMM	4820
Extra 8 Mb memory	4308
Network Interface Card - 1 of:	
Token Ring	4120
Ethernet 10BaseT/2	4161
Fast Ethernet 10/100 Base TX	4402
Twinax SCS	4141

G.1.2 Departmental printer: IBM Infoprint 21

This printer is suitable for printing more complex AFP jobs, as well as PC LAN jobs. The extra paper tray provides flexibility, for example different colored paper or a pre-printed letterhead. The duplex unit enables duplex printing, for example

printing an AFP overlay of terms and conditions on the back or simply reducing paper use for PC word-processing documents. See Table 37.

Table 37. IBM Infoprint 21 hardware expansions

Product/feature name	Feature code
4322 printer	Model 001 (low voltage) Model 002 (high voltage)
IPDS SIMM	4820
Extra 16Mb memory	4316
Network Interface Card - 1 of: Token Ring Ethernet 10BaseT/2 Fast Ethernet 10/100 Base TX Twinax SCS	4120 4161 4162 4141
Duplex Unit	4402
Additional Input Drawer and Tray	4501
Note: The AS/400 print kit that is available, which includes Ethernet and IPDS, is a single package.	

G.1.3 AS/400 production printer and PC LAN departmental printer

This configuration provides a fast, well-equipped printer suitable for use as the main production printer for a small company or one of several departmental printers in a larger enterprise. The numerous input drawers and output bins provide great flexibility in paper handling. The hard drive provides a copier-like "Repro" facility for generating multiple copies of PC jobs without additional printer processing. See Table 38.

Table 38. AS/400 production printer and PC LAN departmental printer hardware expansions

Product/feature name	Feature code
4332 printer	Model 004 (low voltage) Model 005 (high voltage)
IPDS SIMM	4820
Extra 32Mb memory	4332
Network Interface Card - 1 or 2 of: Token Ring Ethernet 10BaseT/2 Fast Ethernet 10/100 Base TX Twinax SCS	4120 4161 4162 4141
Duplex Unit	4402
2,500 sheet input unit	4520
2,000 sheet finisher	4620 (low voltage) 4621 (high voltage)
Face-up output tray	4630
Hard Drive	4320

G.2 Ordering and obtaining software

The following software is required:

- Print Services Facility/400 (PSF/400)
- IBM AFP PrintSuite for AS/400, Advanced Print Utility feature
- AFP Font Collection

The following software is useful but not essential:

- AFP Utilities/400
- IBM AFP Driver for Windows
- Client Access/400, Operations Navigator feature

Note that ValuPak for AS/400 Printing (5769-PPK) includes the following software products:

- IBM AFP PrintSuite for AS/400, Advanced Print Utility feature
- IBM AFP PrintSuite for AS/400, PPFA/400 feature
- AFP Font Collection
- AFP Utilities/400

Note: At V4R5, AFP Font Collection is included with new orders of PSF/400.

G.2.1 Checking whether the software is already installed

On an OS/400 command line, type:

```
DSPSFWRSC
```

A screen similar to the example shown in Figure 253 appears.

Display Software Resources				System: DEMO720A
Resource ID	Option	Feature	Description	
5769999	*BASE	5050	AS/400 Licensed Internal Code	
5769SS1	*BASE	5050	Operating System/400	
5769SS1	*BASE	2924	Operating System/400	
5769SS1	1	5050	OS/400 - Extended Base Support	
5769SS1	1	2924	OS/400 - Extended Base Support	
5769SS1	2	5050	OS/400 - Online Information	
5769SS1	2	2924	OS/400 - Online Information	
5769SS1	3	5050	OS/400 - Extended Base Directory Support	

Figure 253. Display Software Resources

Note: The Enhanced Print Kit combines the Ethernet and IPDS features.

G.2.1.1 PSF/400

Page down through the list, and look for an entry similar to the example in Figure 254 (OS/400 V4R4) or Figure 255 on page 346 for releases prior to OS/400 V4R4. Both screens confirm that you have PSF/400 installed.

Resource			
ID	Option	Feature	Description
5769SS1	36	5112	OS/400 - PSF/400 1-20 IPM Printer Support

Figure 254. PSF/400 installed confirmation screen: OS/400 V4R4

Resource			
ID	Option	Feature	Description
5769SS1	17	5102	OS/400 - Print Services Facility
5769SS1	17	2924	OS/400 - Print Services Facility

Figure 255. PSF/400 installed confirmation: Releases prior to OS/400 V4R4

G.2.1.2 AFP PrintSuite/400: APU feature

Page down through the list, and look for an entry similar to the example shown in Figure 256.

Resource			
ID	Option	Feature	Description
5798AF3	*BASE	5050	AFP PrintSuite for AS/400
5798AF3	*BASE	2924	AFP PrintSuite for AS/400
5798AF3	1	5101	Advanced Print Utility for AS/400
5798AF3	1	2924	Advanced Print Utility for AS/400

Figure 256. APU feature list display

You can also access the main menu by typing the command:

```
GO QAPU/APU
```

If you do not see option 8 (Configure APU Monitor Action), you are using the V3R7M0 (or V3R2M0) product version. Contact your IBM representative to order the no-charge maintenance upgrade of V3R7M1.

G.2.1.3 AFP Font Collection

You might have noticed AS/400 AFP font products installed on your system in the above displays. The AFP Font Collection is not installed as a licensed program product and, therefore, does not show up in these displays. Typically the various font libraries are installed into libraries such as QFNT300LA1. To check whether these libraries are present, type:

```
WRKLIB QFNT*
```

If the only library displayed is QFNTCPL, this contains the original 240-pel fonts supplied with OS/400 and is unlikely to be of use. You may also see libraries QFNT00 to QFNT15 and QFNT61 to QFNT65. These also contain 240-pel fonts.

Assuming you use 300-pel fonts, the only sure way to check for the presence of these fonts on your system is to type:

```
WRKFNTRSC FNTRSC(*ALL/*ALL) OBJATR(FNTCHRSET)
```

From the list of fonts returned, use option 5 (Display attributes) to check the pel density of the selected font. If you do not have any 300-pel fonts installed, you need to order the AFP Font Collection.

Note

You may also find outline (resolution-independent) fonts installed (with a pel density attribute of "OUTLINE"). These are a good choice of font, but you must ensure your printer is capable of using them. Examples include IBM Infoprint 20, 21, 32, and 40.

G.2.1.4 AFP Utilities/400

Use the DSPSFWRSC command again, and look for a screen similar to the example shown in Figure 257.

Resource ID	Option	Feature	Description
5769AF1	*BASE	5050	IBM AFP Utilities for AS/400
5769AF1	*BASE	2924	IBM AFP Utilities for AS/400

Figure 257. AFP Utilities/400 resource display

G.2.1.5 IBM AFP Driver for Windows

From your chosen Windows PC, select **Add Printer**. Follow the wizard instructions through the first few screens until the printer manufacturer and model appears, which is shown in Figure 258.

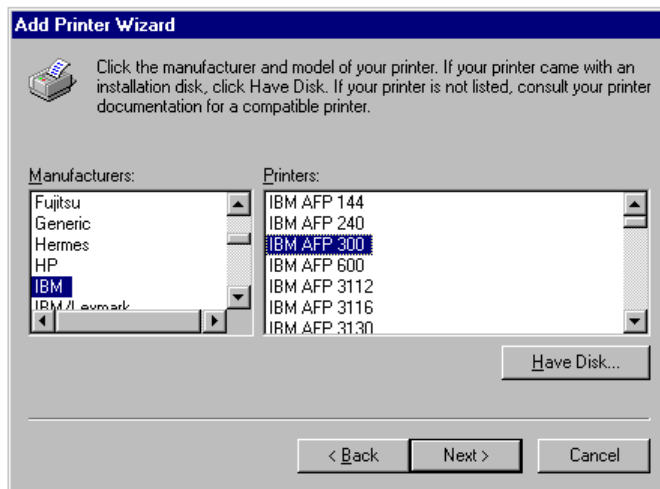

Figure 258. Printer manufacturer and model display

If you see the display shown in Figure 258, you have at least one of the IBM AFP Drivers installed or have the ability to install it.

G.2.1.6 Client Access/400: Operations Navigator feature

Click **Start->IBM Client Access**. Verify that the AS/400 Operations Navigator appears in the list of components. You can use either Client Access Express for Windows or the original Client Access for Windows 95/NT.

For further information about Operations Navigator, refer to the Client Access documentation and *Managing AS/400 V4R4 with Operations Navigator*, SG24-5646.

G.3 Installing the software

All the software may be installed “in-flight” without affecting system operations. We recommend that you follow this sequence:

1. PSF/400
2. AFP Utilities/400
3. AFP Font Collection
4. Advanced Print Utility

Instructions for installing each software product are included in the “Program Directory” page shipped with the product. However, a quick guide to the installation is covered in the following section.

G.3.1 PSF/400

On a command line, type:

```
GO LICPGM
```

Select option **11** (Install licensed programs). For V4R3 and earlier versions, install Option 17 (Print Services Facility/400). For V4R4 and later versions, install option 36, 37 or 38, depending on which software tier you purchased. See Figure 259.

Option	Licensed Program	Product Option	Description
	5769SS1	36	OS/400 - PSF/400 1-20 IPM Printer Support
	5769SS1	37	OS/400 - PSF/400 1-45 IPM Printer Support
	5769SS1	38	OS/400 - PSF/400 Any Speed Printer Support

Figure 259. V4R4 and higher install options

G.3.2 AFP Utilities/400

This product may be on the same CD as the PSF/400 feature. Again, go to the Install Licensed Programs menu. You will install product 5769-AF1. This may be at release V4R2 or V4R4.

G.3.3 AFP Font Collection

There is no need to install all the 70 and greater font libraries on the CD or tape media. The most likely ones you will want to install are listed in Table 39, together with their name on the CD-ROM and an explanation of what they contain.

See 4.4.1, “Making the fonts available” on page 97, for a font utility that assists in installing the AFP Font Collection.

Table 39. Commonly installed font libraries

AS/400 font library name	File name on CD-ROM media	What they contain	When to install
QFNTCDEPAG	CDEPAG	Code Pages	Always
QFNT300CPL	300CPL	300-pel versions of the standard OS/400 fonts in QFNTCPL	If printing to 300-pel printers ^{1 3}

AS/400 font library name	File name on CD-ROM media	What they contain	When to install
QFNT300LA1	300LA1	300-pel Expanded Core fonts for the Latin 1 language group	If printing to 300-pel printers and using the Latin1 language group ²
QFNT240LA1	240LA1	240-pel Expanded Core fonts for the Latin 1 language group	If printing to 240-pel printers ³
QFNTOLNLA1	OLNLA1	Outline fonts for the Latin 1 language group	If printing to printers capable of using downloaded outline fonts ³
<p>Notes:</p> <ol style="list-style-type: none"> 1. Or higher-resolution printers emulating 300-pel printers 2. The various language groups and the languages they support are defined in the Program Directory. Therefore, you might install a different font library, for example QFNT300LA3. 3. To determine the relevant characteristics of your printer, refer to the table in Appendix E, "Printer summary" on page 313. 			

Additional font libraries you may want to install are listed in Table 40. The 240-pel versions of these libraries are also available.

Table 40. Additional font libraries

AS/400 font library name	File name on CD-ROM media	What they contain	What they provide
QFNT300OCR	300OCR	300-pel Optical Character Recognition fonts	Support for OCR characters and additional monospaced fonts
QFNTOLNOCR	OLNOCR	Outline Optical Character Recognition fonts	Support for OCR characters and/or additional monospaced fonts
QFNT300APL	300APL	300-pel APL programming language fonts	Support for APL characters and/or additional monospaced fonts
QFNTOLNAPL	OLNAPL	Outline APL programming language fonts	Support for APL characters and additional monospaced fonts
QFNT300BM	BM300	300-pel IBM BookMaster fonts	To provide additional monospaced fonts
QFNTOLNBM	BMOLN	Outline IBM BookMaster fonts	To provide additional monospaced fonts
QFNT300SYM	SYM300	300-pel Symbols fonts	To provide additional scientific, mathematical and special purpose characters

AS/400 font library name	File name on CD-ROM media	What they contain	What they provide
QFNTOLNSYM	SYMOLN	Outline Symbols fonts	To provide additional scientific, mathematical and special purpose characters

G.3.4 Advanced Print Utility

You cannot install this product through the GO LICPGM menu. Instead, use the following two commands (assuming the media is CD-ROM in a device named OPT01):

- RSTLICPGM LICPGM(5798AF3) DEV(OPT01) OPTION(*BASE)
- RSTLICPGM LICPGM(5798AF3) DEV(OPT01) OPTION(1)

The most current release of this product is V3R7M1.

G.3.5 Additional steps that may be required

The software is now installed and ready to use. The following steps customize the software according to your local requirements.

G.3.5.1 Setting the APU defaults

Go to the main APU menu which is accessed by typing:

```
GO QAPU/APU
```

While you have a command line present, add any required font libraries to your library list, for example:

```
ADDLIB QFNTCDEPAG
ADDLIB QFNT300LA1
```

Create libraries for the APU print definitions and AFP resources, for example:

```
CRTLIB LIB(APUDATA) TEXT('APU Print Definitions')
CRTLIB LIB(IMAGES) TEXT('AFP Images')
CRTLIB LIB(OVERLAYS) TEXT('AFP Overlays')
```

Select option 6 (Set APU Defaults) and fill in the fields as desired. An *example* is shown in Figure 260.

```

Set APU Defaults

Type choices, press Enter.
Unit of measure . . . . *CM          *INCH, *CM, *ROWCOL, *UNITS
Decimal point character . . . . . . . or ,
Font family . . . . . COURIER LATIN1 Value          F4 for List
Color . . . . . *DEFAULT          *DEFAULT, Value F4 for List
Definition library . . . APUDATA     Name
Code Page . . . . . T1V10285       Name          F4 for List

Addl. resource libs. . . IMAGES      Name
                             OVERLAYS Name
                             Name
                             Name

Job description . . . . . QYPUJOB     Name
Library . . . . . *LIBL             Name, *LIBL

```

Figure 260. Set APU Defaults example

G.3.5.2 Program temporary fixes for APU

While you are setting up your APU environment, consider ordering PTF SF62571. This may be loaded and applied immediately. The PTF fixes several minor APU problems, including AFP overlay and page segments moving with APU page margins, and only one SCS spooled file being displayed when selecting a spooled file for creating print definitions.

G.3.5.3 APU font database synchronization

If for any reason you did not install APU after installing the AFP Font Collection, the internal fonts database that APU uses will not reflect what is installed on the system. This situation might also arise if you later add a font library, or add custom fonts. To re-synchronize the fonts database, type:

```
CALL QAPU/QYPUSYNC
```

This may take a few minutes to run. You can run it at any time, but if the fonts are in use by an application (for example, being applied in an APU print definition) the program may fail. Wait a few moments, and then call the program again.

G.4 Designing electronic documents

There are many guides to creating printed documents, from typographer's guides to magazine articles. While a complete understanding of this extensive skill is not required, a few simple guidelines will improve the quality and comprehension of your documents.

First decide whether you are directly replicating your pre-printed stationery, or completely re-designing it. The former is easier, but this is also an ideal time to bring your documents up-to-date, so perhaps a combination of the two would be appropriate. For example you might keep the general look of an invoice, but with a new company logo. A more radical change would be to move from a landscape to portrait format. This will make the presentation more consistent, from paper to fax, for example. Now is a good time to question whether the information you have on the form really needs to be there, whether it is on the pre-printed form or printed from the application. You can also cut down on the number of additional

copies generated. Conversely, you can determine if an additional, automatic copy of the document would benefit your organization.

Ideally, choose a single document (such as an invoice) and re-design it, keeping in mind that a similar document, such as a credit note or purchase order, may have slightly different fields. Allow space and the correct registration for addresses, especially if you use window envelopes. White (empty) space does not necessarily have to be filled and often adds clarity.

If you or another department have a “mock-up” prepared using a Windows application, remember that this can form the basis for the actual AFP overlay, using the IBM AFP Driver for Windows. However most users tend to cram too much detail onto such forms and in particular do not consider registration of addresses within window envelopes (and concealment of confidential data away from the window). If the mock-up design does not contain more advanced features such as curved boxes and lines, you will later find it much easier to map text using APU if the AFP overlay is constructed using AFP Utilities/400. The latter method will also construct a much more efficient overlay, in terms of printing performance.

G.4.1 Which fonts to use

Fonts are a potential area of conflict, between the wishes of the marketing department and the document ease of creation. Sans serif fonts, such as Helvetica make bold headings, while a serif font, such as Times New Roman, provides a more formal look and makes large areas of text easier to read. An example of the latter might be Terms and Conditions printed as an AFP overlay on the back of an invoice. Numeric data needs to be in a monospaced font (where every character is of equal width) so that the figures align. Examples include Courier, Prestige, Gothic Text, Letter Gothic, and IBM BookMaster.

Using fonts within the IBM AFP Font Collection will pay dividends if and when you move to alternative means of presentation for example faxing or viewing. Otherwise, you may need to create an AFP version of your corporate font. If this exists as a PostScript (Adobe Type 1) font, you can use the IBM Type Transformer product to create these fonts, in 240, 300, or AFP Outline format. Remember that you will still need a monospaced font if you have columns of figures to be aligned. See Chapter 4, “Fonts” on page 89, for more information on Type Transformer.

A common technique is to construct all static areas of the form (for example, the overlay) in a typographic font, such as Helvetica and Helvetica Bold. Then map the variable text using a monospaced font throughout, such as Courier, Letter Gothic or BookMaster. This helps the recipient identify which data applies to them and which data is standard text. This is more appropriate for business documents such as statements, invoices and purchase orders. It is less appropriate for individual documents such as letters.

G.5 Creating the resources

With the above advice in mind, you can now start to create your company logos, signatures, electronic forms, and fonts. There are many tools available, but the ones provided in the ValuPak for AS/400 Printing should be sufficient. Table 41 compares and contrasts the different tools.

Table 41. Font creation tools comparison

Tool	Advantages	Disadvantages
AFP Utilities/400	<ul style="list-style-type: none"> • Easy to use, Quick learning curve • Call to AFP Viewer provides WYSIWYG view of electronic form • Produces efficient overlays • Overlay source created, stored, and saved as OS/400 objects on the AS/400 system • May be used from any OS/400 5250 session • Easy to correlate overlay elements positioning with that of the variable text • PC-sourced and designed elements, such as company logos or signatures may be created separately but built into the AFP Utilities/400 overlay 	<p>Only a near-WYSIWYG view in design mode</p>
IBM AFP Driver for Windows	<ul style="list-style-type: none"> • May be used from any Windows application • Permits use of advanced design elements, such as curved lines and boxes, angled text, corporate PC fonts, easy access to clip-art, etc. • Allows use of PC word-processor functions, such as spell-checking and text alignment 	<ul style="list-style-type: none"> • Requires setup and management of the creation process, for example shared folder, AS/400 database file, and driver installation • Backup and storage of the source Windows documents is a separate process to be managed • May be difficult to correlate characteristics of the overlay with that of the AS/400 system, for example lines per inch • Produces relatively inefficient AFP overlays; complex overlays may print slowly on smaller printers

Note that you may use both tools together: AFP Utilities/400 for the bulk of the document, with text, shaded boxes and lines, the IBM AFP Driver to create page

segments of the company logo and signatures, the IBM AFP Driver to create an overlay of Terms and Conditions. Use the appropriate tool for the appropriate task!

An additional possibility is to use the “Define boxes” facility within APU itself. This is a very limited method. There is no WYSIWYG facility at all, nor shaded or curved boxes. Even lines must be drawn as boxes. However if your form is very simple, it may be appropriate to use this facility and, therefore, keep all design elements within APU.

G.6 Building and testing APU print definitions

This step involves mapping the variable text in your spooled files to the new positions in the electronic form. Before you start, we advise that you collect several different examples of your spooled files and place them in a special output queue. One is supplied with APU (QYPUOUTQ in QAPU), but we suggest you create one in the same library you use for your print definitions, for example:

```
CRTOUTQ OUTQ (APUDATA/APUTEST)
```

In addition, create two queues for handling successful and unsuccessful processing of APU print definitions, for example:

```
CRTOUTQ OUTQ (APUDATA/APUOK)
CRTOUTQ OUTQ (APUDATA/APUFAIL)
```

Now you need to locate several sample spooled files that you will use to build your new documents. Pick a simple one, a complex one, and any that are slightly different, for example extending to several pages or with different sequences of data. Store them in the APUTEST queue and ensure they have SAVE=*YES set.

We will refer to these spooled files as the “original SCS spooled files”. It may be helpful to print them out, but do not worry about the fonts or page rotation. We will use APU to set these as required.

Follow the APU User’s Guide to set up the basic elements of the print definition. If you have directly replicated your pre-printed stationery through the AFP overlay, you may not even need to perform any text mapping (“field mapping”). As a minimum, we suggest the following settings:

- **Print definition name:** Same as the spooled file name
- **Set print definition attributes:** Hard-code the page size (for example, US Letter 11 by 8.5 inches or A4 size 11.69 x 8.27 inches), the page rotation (probably 0 or 90), and the margins (set to 0). Set the default font family to a monospaced font, such as Courier, for now.

Save this print definition. Then in the **Define a Copy** section, use the following settings:

- **Set page layout options:** Leave these options at their default settings for now, unless you want to name a Back Overlay.
- **Define field mapping; Define constants; Define boxes; Define page segments:** Leave these settings at their default settings.
- **Define overlays:** Name your AFP overlay here.

You now have enough set up in APU to print one of your original SCS spooled files. Refer to “Manually Associating a Print Definition with a Spooled File” in Chapter 5 of the *APU User's Guide*. Fill in the names of the print definition and the print definition library name (you may be able to select the default settings). In the Post processing SUCCESS/FAILURE fields, set each of these to *OUTQ, and name the output queues as APUOK and APUFAIL respectively. On the second panel, set the output queue name to that of your actual printer output queue (for example, PRT01).

Now press Enter, and observe the bottom left of your screen. A sequence of equals signs and asterisks indicates the progress of the Apply Print Definition process. If a message tells you that the print definition was applied successfully, go to the output queue for your printer and observe the new AFP spooled file there. When this is printed, decide which, if any, of your variable text requires mapping into position and return to the APU Print Definition (Define field mapping) section.

If the print definition was not successfully applied, check your job log as to the cause of the failure. The most common causes of failure are:

- The original SCS spooled file was not in a RDY state (for example it was HLD or SAV)
- The name of your print definition was not found or did not agree with the exact name of the original SCS spooled file
- You do not have the APU print definition library in your library list

If there was a problem, the original SCS spooled file should have been moved to the APUFAIL queue. You can move it back to the APUTEST queue, correct the problem as above, and re-run the test. If successful, the original SCS spooled file will have been moved to the APUOK queue, and you can again move it back to the APUTEST queue or simply use the APUOK queue as your source for further tests. The flowchart in Figure 261 on page 356 shows the possible results of APU processing.

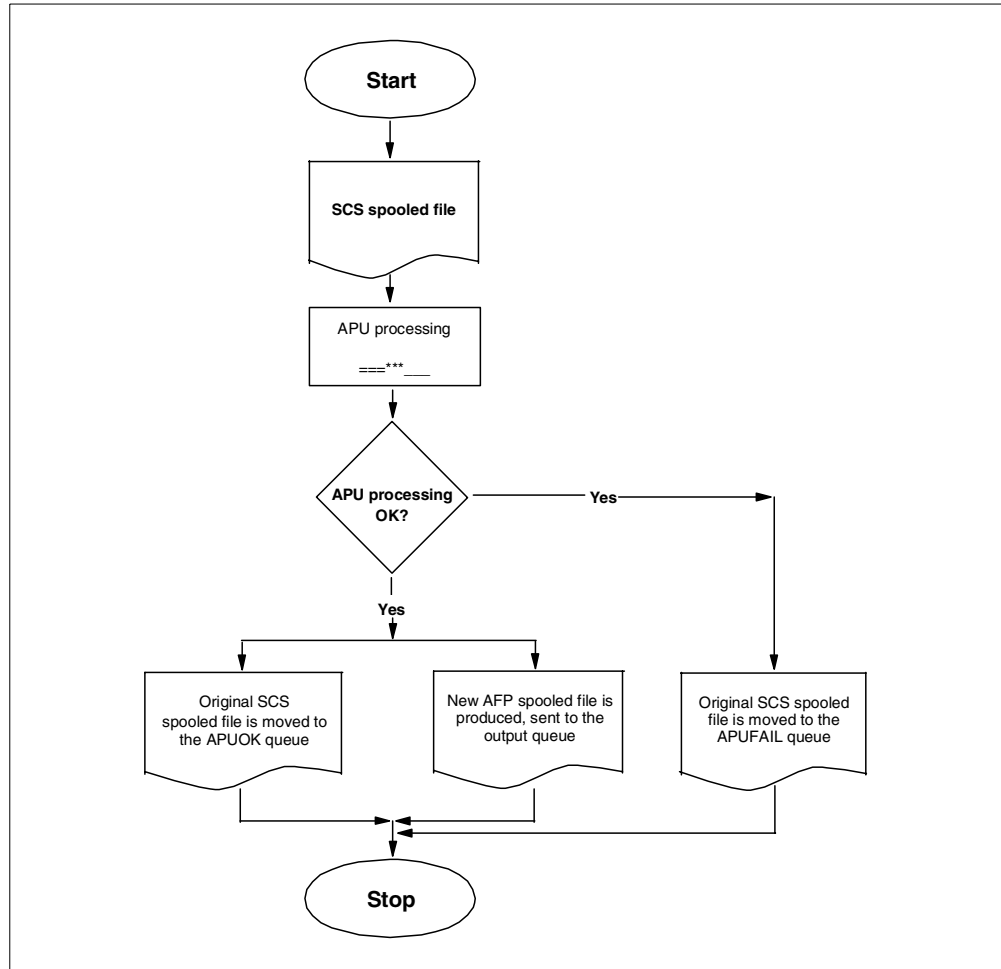

Figure 261. APU processing flowchart

G.6.1 Other common problems

- **Q.** I can't see my sample spooled file on the Select A Sample Spooled File screen

A. Change the output queue to reflect the one you are working with (APUTEST for example) or change the User to *ALL, or your current user ID, or that of the person who produced the sample spooled file. You cannot change the default output queue or user ID for this screen.

Note: If you can only see one sample spooled file in the list, but you know you have several in the test queue, this is a bug that can be fixed by using PTF SF62571.

- **Q.** The APU process produced an AFP spooled file, which printed with my remapped text but with no AFP overlays, or printed in the wrong font.

A. Ensure the library containing your AFP resources, fonts, overlays, page segments, is in your library list

- **Q.** Some of my text was formatted correctly, but some is missing, and there are random characters on the page.

A. The formatting you created in the “Define field mapping” section does not exactly match the underlying data. *Unmapped data will still be printed.* This unmapped data may be partial elements of your data, therefore the appearance of “random” characters!

G.6.2 Viewing APU output

You may find it convenient to view your APU-enhanced spooled files while developing and testing them. It’s also possible for this to be a low-cost means for users to view output instead of printing it.

To do this, start the Operations Navigator component of Client Access/400 from your PC. This assumes you have already set up Operations Navigator within Client Access/400. Select **Basic Operations** and either **Printer Output** or **Printers** as preferred. These are the equivalents of the AS/400 WRKSPLF and WRKWTR commands. If you have a lot of spooled files or output queues, you will improve screen refresh performance by highlighting one of the above choices, and selecting **Options->Include** from the menu bar. Specify your preferred printer and output queues to filter the view. See Figure 262.

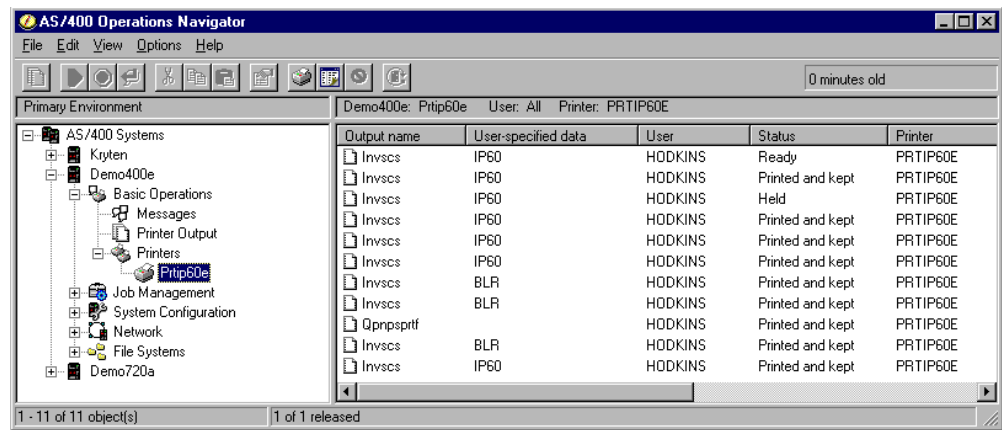

Figure 262. Specifying preferred printer and output queues

When you double-click on a spooled file, the AFP Viewer is invoked automatically and your output may be seen in a WYSIWYG view (see Figure 263 on page 358 for an example). This may save you several trips to the printer and a lot of paper!

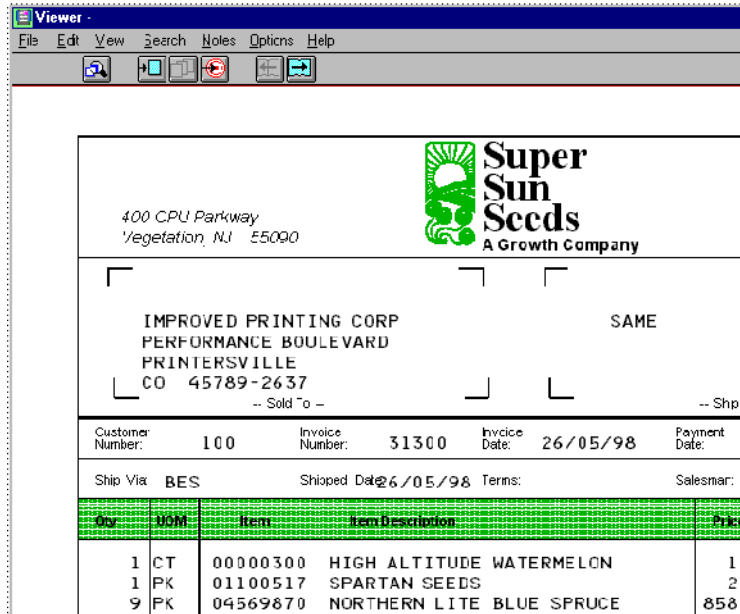

Figure 263. AFP Viewer: Spooled file

If you find that the AFP viewer cannot locate the AFP resources, check the settings of **Options->Preferences->More->Resource Path**. Ensure that you are pointing to an appropriate path, for example the network drive on the AS/400 system where the AFP resources were created.

G.7 Automatically starting the APU Monitor

This section provides advice about using the automated process of capturing SCS spooled files, applying the APU print definitions, and sending the new AFP spooled files to various destinations.

It is intended that the APU Monitor batch process be started from the main APU menu (option 4), for example interactively. Many customers prefer that the job be automatically started along with their other jobs at system startup.

In addition, there is an issue with the APU Monitor that, by default, it runs in QBATCH as a never-ending job (QYPUMON). If QBATCH has a limit on the number of active jobs (such as just 1), this will prevent other batch jobs from starting in QBATCH unless QYPUMON is ended.

There are at least two ways of handling these issues:

- Create an entirely new subsystem, just for the APU Monitor
- Modify QBATCH to allow multiple jobs to run

G.7.1 Creating a separate APU subsystem

The following procedure creates a new subsystem for the APU Monitor. If the naming convention is followed, this procedure still allows you to view the APU Monitor status, and to stop and restart it from the main APU menu if required.

1. Create a new subsystem called APUMON by copying the QBATCH subsystem description:

```
CRTDUPOBJ OBJ(QBATCH) FROMLIB(QSYS) OBJTYPE(*SBSD) NEWOBJ(APUMON)
```

2. Remove the three default job queue entries from APUMON:

```
RMVJOBQE SBSDB(QSYS/APUMON) JOBQ(QGPL/QBATCH)
RMVJOBQE SBSDB(QSYS/APUMON) JOBQ(QGPL/QS36EVOKE)
RMVJOBQE SBSDB(QSYS/APUMON) JOBQ(QGPL/QTXTSRCH)
```

3. Create a job queue called APUMON in QSYS:

```
CRTJOBQ JOBQ(QSYS/APUMON) TEXT('Job Q for APU Monitor')
```

4. Add a new job queue entry to the APUMON subsystem:

```
ADDJOBQE SBSDB(QSYS/APUMON) JOBQ(QSYS/APUMON)
```

5. Make a copy of the APU-supplied job description QYPUJOB in library QAPU, place it somewhere convenient such as QSYS:

```
CRTDUPOBJ OBJ(QYPUJOB) FROMLIB(QAPU) OBJTYPE(*JOB) TOLIB(QSYS)
```

6. Change QSYS/QAPUJOB to refer to job queue QSYS/APUMON:

```
CHGJOB JOB(QSYS/QYPUJOB) JOBQ(QSYS/APUMON) PRTDEV(PRT01)
```

The reference to PRT01 is useful if you know you will always be printing to a single printer (the system printer) or if you want to define a default printer device for APU jobs to use.

7. Modify the APU Defaults (option 6 from the main APU menu) to use the customized job description, for example QSYS/QYPUJOB. Make sure you have the required font, code page, and APU print definition libraries in your library list first. Otherwise, you won't be able to successfully exit option 6.

8. Test the new subsystem by starting it interactively:

```
STRSBS(APUMON)
```

Then start the APU monitor from the main APU menu, option 4. Test with an SCS spooled file placed on a monitored output queue. It should be picked up, and a print definition should be applied and printed.

If the SCS spooled file is already on the output queue, it may be necessary to hold and release it to initiate the process.

9. End the APU monitor by selecting option 5 from the main APU menu, and end the APUMON subsystem:

```
ENDSBS SBS(APUMON) OPTION(*IMMED)
```

10. Test the job to see if it can be started in batch by using the following command:

```
STRSBS(APUMON)
SBMJOB CMD(CALL PGM(QAPU/QYPUDQMN) JOB(QYPUMON)
          JOBD(QSYS/QYPUJOB))
```

11. Test the job again with an SCS spooled file. If it is successful, create a small CL program with the above two lines of code, and add the program to your startup procedures.

Note: You could use any JOB name above, but if you use QYPUMON, you can then check the status of the APU Monitor from the main APU menu using option 3. Also note that you can stop and start the APU Monitor using options 4 and 5.

The above is one method of automating the APU Monitor. It creates a totally separate subsystem that you can take down or bring up at will without disturbing

any other batch operations. Because it is called APUMON, it is more likely to appear at the top of the list in WRKACTJOB, which is convenient.

Another method of automating the APU Monitor is to modify QBATCH itself.

G.7.2 Modifying QBATCH to allow multiple jobs to run

You *could* use either of the following commands:

```
CHGJOBQE SBSDB(QBATCH) JOBQ(QBATCH) MAXACT(n+1)  
MAXACT(*NOMAX)
```

Here, *n* is the current number of maximum active jobs, and *n+1* is simply your adding an extra job to the MAXACT number.

There are several issues here. One is the performance implication of unlimited jobs running in QBATCH. Another is that if there is still a limit, QYPUMON may still be unable to run or may prevent another job from running.

If you continue with this procedure, you must add the CL command (CALL PGM(QAPU/QYPUDQMN) from the procedure above to your startup CL programs. Instead of starting a separate APUMON subsystem though, you need an instruction that says, “Whenever the QSPL subsystem starts, I want QYPUMON to start as well”. This is called an *auto-start job entry*. Use a command similar to:

```
ADDAJE SBSDB(QSPL) JOB(QYPUMON) JOBD(QAPU/QYPUJOB)
```

G.8 Using APU for production printing

Only when you have created some working APU print definitions and started to have them automatically applied through the APU Monitor, you will see how powerful the APU batch process is. This section describes case studies where various elements of AFP and APU have been exploited to meet real customer requirements.

G.8.1 Using APU Monitor Actions

An APU Monitor Action is a single or repeated application of your APU print definition to an SCS spooled file. You might use this process to:

- Produce two copies of an AFP spooled file, sent to two or more different printers, perhaps in different locations
- Perform some other form of output, for example to fax the AFP spooled file or send it to an archival system, as well as printing it
- Store a copy of the AFP spooled file on an output queue for reprinting in case the output becomes damaged or spoiled
- Route a non-AFP spooled file to a different printer or location

The above list largely assumes you are generating multiple identical copies of the AFP spooled file. There is no reason why the AFP spooled files should not differ slightly. The following section describes how to setup the different APU Monitor Actions to realize the sample requirements presented previously.

G.8.1.1 Sending an AFP spooled file to multiple destinations

Let's suppose you want to print a formatted AFP report in two different locations. The data in the report is identical in all respects. You want to print the address of the receiving location at the top of the report. Obviously, this address will be different. Traditionally, the printers would have been loaded with pre-printed headed stationery to achieve this. Let's assume you created an electronic overlay of just the address, called ADDRESS. You store this in a location-specific library, for example LONDON. The overlay for the second location is also called ADDRESS, but stored in a library called DUBLIN.

The APU print definition is common to both locations, so you store that in your general-purpose library (for example APUDATA, along with any other general-purpose overlays: with lines, boxes, and shading for example).

Finally, you add the libraries to the PSF configuration objects for the location printers. LONDPRT1 has libraries APUDATA and LONDON, and DUBPRT1 has libraries APUDATA and DUBLIN.

The APU Monitor action looks like the display shown in Figure 264.

```

Define action for output spooled file

Sequence . . . . . : 100
Text . . . . . : Send report to LONDON printer
Action . . . . . : 1 / 1
Panel . . . . . : 1 / 2
Type choices, press Enter.
User exit before . . . *NONE          Name, *NONE
Library . . . . .      Name, *LIBL
User parameter . . .   Value
Print Definition . . . *SPOOLFILE     Name, *SPOOLFILE, *NONE
Library . . . . .      *PRTDEFLIB     Name, *PRTDEFLIB, *LIBL
Run option . . . . .  *NORMAL          *NORMAL, *NOCOPY, *REPRINT
User exit middle . . . *NONE          Name, *NONE
Library . . . . .      Name, *LIBL
User parameter . . .   Value
Output device . . . . . *JOB           Name, *JOB
Output queue . . . . . LONDPRT1      Name, *DEV, *SPOOLFILE
Library . . . . .      *LIBL          Name, *LIBL
More...
F12=Cancel                      F15=Next action

```

Figure 264. APU Monitor action display

The settings on the next page can be changed as required. Now press F15 (Next Action), and repeat the above settings except for the following two parameters:

```

Run option . . . . .      *REPRINT    *NORMAL, *NOCOPY, *REPRINT
Output queue . . . . .    DUBPRT1    Name, *DEV, *SPOOLFILE

```

Note the use of the *REPRINT run option. This is very important from an AS/400 performance point of view. Since you have already created the AFP spooled file, there is no need to go through the processing of it again. Simply send it to the remote printer. The AFP spooled file is already “tagged” with a reference to use the Dublin address overlay. This is found in the printer’s Device Resource library list in the PSF configuration object.

The above approach also has benefits in maintaining the forms. If and when the location telephone or fax number changes, you simply make *one* small change to *one* overlay object. No other important parts of the print production are affected. Conversely, if the company decides on a change to the font or lines/boxes on the Invoice overlay, the main Invoice overlay can be changed, and the updated result will be in immediate effect at all locations, local and remote.

G.8.1.2 Sending (slightly different) AFP spooled files to multiple destinations

You should be able to see that the above example may easily be extended to placing the AFP spooled file copies on output queues that actually point to other devices, such as a fax output queue or an output queue monitored by an archiving process.

You could enhance the process slightly and request that the faxed AFP spooled file contains a fax message along the lines of “This is your faxed copy; a printed confirmation will be with you in 24 hours”. We can easily generate an overlay to convey this message. However, the addition of this overlay is no longer location-specific (London/Dublin), but action-specific (print and fax? or just print?).

Let’s assume that to generate a combined faxed/printed document, the application places the SCS spooled file on a specific output queue, called FAXPRINT (this could also be a manual process). You have a print definition called INVOICE, in library APUDATA. You also have a copy of this print definition, called INVOICEF, which is the same print definition but with the “Fax Message” overlay described above included in all the page formats. There are two keys to make this work. First, you monitor the FAXPRINT output queue in Define Selection for Input Spooled File. Second, having made a successful selection, you have two APU Monitor actions as before, in Define Action for Output Spooled File. The difference this time is that, as well as different printer output queues (one of them being the fax queue LONDFAX), the second APU Monitor Action specifies a different print definition name as shown in Figure 265 through Figure 267.

```

Define selection for input spooled file
Sequence . . . . . : 110
Text . . . . . : Send report to LONDON fax queue & printer

Type choices, press Enter.

File . . . . . *ALL      Name, Generic*, *ALL
Output queue . . . . . FAXPRINT Name, Generic*, *ALL
  Library . . . . . *LIBL    Name, *LIBL
User . . . . . *ALL      User, Generic*, *ALL
User Data . . . . . *ALL    User Data, Generic*, *ALL
Form Type . . . . . *ALL    Form Type, Generic*, *ALL
Program . . . . . *ALL     Name, Generic*, *ALL
  Library . . . . .      Name, *LIBL

```

Figure 265. APU Monitor Action: Specifying a different print definition

```

Define action for output spooled file

Sequence . . . . . : 110
Text . . . . . : Send report to LONDON fax queue & printer
Action . . . . . : 1 / 1
Panel . . . . . : 1 / 2
Type choices, press Enter.
User exit before . . . *NONE          Name, *NONE
Library . . . . .      Name, *LIBL
User parameter . . .   Value
Print Definition . . . *SPOOLFILE     Name, *SPOOLFILE, *NONE
Library . . . . .      *PRIDEFLIB      Name, *PRIDEFLIB, *LIBL
Run option . . . . .   *NORMAL         *NORMAL, *NOCOPY, *REPRINT
User exit middle . . . *NONE          Name, *NONE
Library . . . . .      Name, *LIBL
User parameter . . .   Value
Output device . . . . . *JOB          Name, *JOB
Output queue . . . . . LONDPRT1      Name, *DEV, *SPOOLFILE
Library . . . . .      *LIBL          Name, *LIBL
More...
F12=Cancel          F15=Next action

```

Figure 266. Define action for output spooled file (Part 1 of 2)

```

Define action for output spooled file

Sequence . . . . . : 110
Text . . . . . : Send report to LONDON fax queue & printer
Action . . . . . : 2 / 2
Panel . . . . . : 1 / 2
Type choices, press Enter.
User exit before . . . *NONE          Name, *NONE
Library . . . . .      Name, *LIBL
User parameter . . .   Value
Print Definition . . . INVOICEF      Name, *SPOOLFILE, *NONE
Library . . . . .      *PRIDEFLIB      Name, *PRIDEFLIB, *LIBL
Run option . . . . .   *NOCOPY       *NORMAL, *NOCOPY, *REPRINT
User exit middle . . . *NONE          Name, *NONE
Library . . . . .      Name, *LIBL
User parameter . . .   Value
Output device . . . . . *JOB          Name, *JOB
Output queue . . . . . LONDFAX      Name, *DEV, *SPOOLFILE
Library . . . . .      *LIBL          Name, *LIBL
More...
F12=Cancel  F14=Previous action  F15=Next action

```

Figure 267. Define action for output spooled file (Part 2 of 2)

Note the different Run option. The *NOCOPY name is a little misleading. The “no copy” refers to the internal process of copying the original SCS spooled file and, in this case, no internal copy is required. What actually happens is that only some re-processing is necessary, for example the application of a different print definition.

For a summary, see Table 42.

Table 42. APU action and Run option summary

If you have:	Use Run option:
Only one APU Monitor Action	*NORMAL
Second, or subsequent Action, same print definition	*REPRINT
Second, or subsequent Action, different print definitions	*NOCOPY

G.8.1.3 Saving a copy of the AFP spooled file

You may decide to keep a copy of the AFP spooled file for 24 hours to guard against the printed documents being spoilt (for example being torn in a mailing machine). You could keep a copy of the original SCS spooled file, but you would then have to go through the APU processing again. To do this, simply create additional output queues, for example LONDPRT1S (“S” for “save”). Name this queue in the last APU Monitor Action, with a Run option of *REPRINT and Save *YES. You could devise a manual or automatic process for clearing down the output queue daily, using the CLROUTQ command.

G.8.1.4 Routing non-AFP spooled files through APU

As a bonus, the APU Monitor Actions provide a reasonable method of spooled file re-routing. Suppose there is the possibility that users might send spooled files ineligible for AFP processing to the printer, for example a screen print. You need to handle these cases (referred to as a “drop-through” because the spooled file does not meet any of the APU Monitor Action criteria and “drops through” the list of actions to the end).

To do this, add an action entry near the end of the list to capture these cases. It is likely that the spooled file name or the output queue will be generic, with use of the “*” wildcard. On the third Action Entry (Define Action for Output Spooled File), the print definition name is set as *NONE. That is, no APU print definition will be applied, and no AFP spooled file will be created. The re-routing is done in the second Action Entry (Define action for input spooled file). In the Success field, enter the name of the desired target output queue. See Figure 268 for an example.

```

Define action for input spooled file

Sequence . . . . . : 900
Text . . . . . : Drop through for screen prints

Type choices for input spooled file after successful
or failed processing respectively, press Enter.

Success . . . . . *OUTQ *NONE, *HOLD, *DELETE, *OUTQ
  Output queue . . . . . QPRINT Name
  Library . . . . . *LIBL Name, *LIBL

Failure . . . . . *HOLD *NONE, *HOLD, *DELETE, *OUTQ
  Output queue . . . . . Name
  Library . . . . . Name, *LIBL

```

Figure 268. Define action for input spooled file: Success field

G.9 Documentation

It is important to define a good naming convention for all your AFP resources, print definitions, libraries, and so on, from the beginning. Remember that OS/400 is much more limited in its names than Windows. For example, an overlay name is restricted to eight characters.

G.9.1 Documenting APU component names

Items that you should record include:

- APU Defaults (option 6 from the main APU menu)
- APU Print Definition names and libraries
 - Page Format names and copy names
- APU Print Definition Attributes
- AFP resource names and libraries:
 - Overlays
 - Page segments
 - Fonts
 - Page segments and fonts used *within* an overlay
- Source document names and location if not on the AS/400 system
- APU Print Definition page format selection rules
- APU Monitor Action Entries
- Any special notes about the application

A working spreadsheet is very useful to have alongside you while creating the documents. It then becomes a valuable documentation source for the completed project. See Table 43 for an example.

Table 43. Working spreadsheet example

IBM AFP Naming Conventions - London								
Spool File Number	Print Definition Name	APU Page Formats	APU Copies	Overlays	AS/400 Library	APU Monitor Steps	WinNT Path for source overlay documents	Notes
LONDON INVOICES								
INV694000	INV694000	INVFIRST	CLIENT	INVFIRST	APUDATA	10	N:\AFP\INVOICE\INVFIRST.DOC	Picked from Bin 1 (plain paper)
				INVBAC			N:\AFP\INVOICE\INVBAC.DOC	INVBAC prints on reverse side
			OFFICE	INVFIRST				Picked from Bin 2 (yellow paper, pre-punched)
				OFFICE			N:\AFP\INVOICE\OFFICE.DOC	OFFICE overlay prints on front side
		INVANY	CLIENT	INVANY			N:\AFP\INVOICE\INVANY.DOC	Picked from Bin 1 (plain paper)
				INVBAC				INVBAC prints on reverse side
			OFFICE	INVANY				Picked from Bin 2 (yellow paper, pre-punched)
				OFFICE				OFFICE overlay prints on front side

The example in Table 43 shows only a suggestion for the column headings. For example, if you were also using AFP Utilities/400 to create the overlays, you might have a column to indicate their names and locations. The example also shows another column for any page segments used *within* the AFP Utilities overlays.

A separate page in the spreadsheet could record the APU Monitor Action steps. See Table 44 for an example.

Table 44. Spreadsheet recording APU Monitor Action steps

IBM AFP APU Monitor Actions															
Action No.	Action Name	Selection for Input Spooled File			Action for Input Spooled File				Action #1 for Output Spooled File						
		SPLF name	OUTQ	USER	Success	OUTQ	Failure	OUTQ	Print Definition	Run opt	Device	OUTQ	Hold	Save	Outbin
10	London Invoices	INV694000	PRT01A	*ALL	*HOLD	n/a	*OUTQ	APUFAIL	APUDATA\INV694000	*NORMAL	PRT01	PRT01	*NO	*YES	*DEVD

Such spreadsheets are valuable only if they are kept up-to-date! Much of the required information may be printed directly from APU, using option 5 (Display contents) or option 6 (Print contents) from the Work with Print Definitions menu in APU. Note that option 6 may generate many pages. It is usually better to copy and paste the required information into a spreadsheet or other PC document.

G.9.2 Where APU print components are stored

For the purposes of backup or transfer to another system, Table 45 records how and where the main APU components are stored on the AS/400 system.

Table 45. APU component storage information

APU component	OS/400 object type	Object attribute	Object name	Library
APU print definition	*USRSPC	APUPRTDEF	User-defined	User-defined
APU Monitor Action Rules	*FILE	PF	QAYPUMA0	QUSRSYS
APU fonts database	*FILE	PF	QAYPUFN0	QUSRSYS

Appendix H. AS/400 to AIX printing

There are a number of ways of sending AS/400 spooled files to an Infoprint Manager for AIX server. Each one has different advantages depending on a variety of considerations, such as the data stream type of the spooled file and the supported target printer, number and diversity of applications and printers, customer preference, and available programming skills.

This appendix attempts to provide guidelines to the different approaches, when they could be used, and additional tips. This appendix has been written from the view point of an AS/400 user, and assumes that an Infoprint Manager for AIX specialist is available.

H.1 TCP/IP versus SNA

There are basically two diverse ways of using Infoprint Manager for AIX as a server for AS/400 printing. Sending files to the server over TCP/IP allows you to take advantage of many of the features of Infoprint Manager for AIX to manage your output, such as queue management, printer pooling, and sharing printers with other clients. PSF Direct, over an SNA connection, allows the AS/400 system to use the Infoprint Manager for AIX connected printer as if it were attached to the AS/400 system directly.

H.1.1 Sending spooled files using TCP/IP

The TCP/IP command to send a spooled file from the AS/400 system to Infoprint Manager for AIX is LPR. The AS/400 system has an alias for LPR, which is SNDTCPSPLF. These two commands are equivalent. You can use either command directly on the command line or in a CL program, or indirectly by setting up a remote output queue.

H.1.1.1 Remote Output Queue

Figure 269 on page 368 shows an example of creating a Remote Output Queue. In this particular example, all spooled files are of DEVTYPE(*AFPDS). No transformation needs to happen to these types of files.

```

                                Create Output Queue (CRTOUTQ)
Output queue . . . . . OUTQ          > IP60AIX
  Library . . . . .                > QUSRSYS
Maximum spooled file size:      MAXPAGES
Number of pages . . . . .          *NONE
Starting time . . . . .
Ending time . . . . .
                                + for more values
Order of files on queue . . . . SEQ   *FIFO
Remote system . . . . . RMTSYS      > 'INFOPRNT'
Remote printer queue . . . . RMTprtQ > 'IP60-1'
Writers to autostart . . . . . AUTOSTRWTR > 1
Queue for writer messages . . . MSGQ  QSYSOPR
  Library . . . . .                *LIBL
Connection type . . . . . CNNTYPE   > *IP
Destination type . . . . . DESTTYPE > *OTHER
Host print transform . . . . . TRANSFORM > *NO
Manufacturer type and model . . MFRTYPMDL *IBM42011
Workstation customizing object WSCST  *NONE
  Library . . . . .
Image configuration . . . . . IMGCFG  *NONE
Internet address . . . . . ININETADR >
Destination options . . . . . DESTOPT > '-odatat=afpds'
Print separator page . . . . . SEPPAGE *YES
User defined option . . . . . USRDFNOPT *NONE
User defined object:           USRDFNOBJ
  Object . . . . .                *NONE
  Library . . . . .
  Object type . . . . .
User driver program . . . . . USRDRVPGM *NONE
  Library . . . . .
Spooled file ASP . . . . . SPLFASP   *SYSTEM
Text 'description' . . . . . TEXT    > 'OutQ to send AFPDS to IP60
attached to IPM for AIX'

Display any file . . . . . DSPDTA    *NO
Job separators . . . . . JOBSEP      0

Operator controlled . . . . . OPRCTL  *YES
Data queue . . . . . DTAQ           *NONE
  Library . . . . .
Authority to check . . . . . AUTCHK   *OWNER
Authority . . . . . AUT              *USE

```

Figure 269. Remote Output Queue creation example

The parameter descriptions shown in Figure 269 are explained here:

- **OUTQ:** Give the output queue on the AS/400 system a meaningful name that corresponds to the destination on the Infoprint Manager for AIX system.
- **RMTSYS:** Remote System. This is the system name of the Infoprint Manager for AIX server. Enter the actual name here, and then add the AIX system's host name to the AS/400 host table using the AS/400 CFGTCP option 10. Alternately, you can enter the value *INTNETADR, and then use the INTNETADR field to specify the address directly. If the name is in lower case, enclose it between single quotes.
- **RMTprtQ:** Remote Printer Queue. This corresponds to the Infoprint Manager for AIX Logical Destination (not the Infoprint Manager for AIX queue). If the name contains lower case, enclose it between single quotes.

- **CNNTYPE:** Connection Type. Must be specified as *IP.
- **DESTTYP:** Destination Type. Must be specified as *OTHER.
- **TRANSFORM:** Host print transform. This parameter determines whether the AS/400 spooled file is sent as is or is translated to ASCII. For example, *AFPDS spooled files are not transformed. Spooled files that are *SCS will need to be transformed. This will be discussed further in H.2, “AS/400 spooled file data streams” on page 372.
- **MFRTYPMDL:** Manufacturer Type and Model. If you specify TRANSFORM(*YES), use this parameter to specify how the transform is to take place. If you are using an IBM supplied transformation, you would enter the name here, such as *IBM4332 or *HP5SI. If you create a Workstation Customization Object, enter the value *WSCST here, and use the next parameter to name the object and its library.
- **WSCST:** Workstation Customizing Object. Use this entry to name your own Workstation Customization Object.
- **DESTOPT:** Destination Options. This parameter allows you to specify some of the processing options to Infoprint Manager for AIX. Enclose the options in single quotes. Details on using the DESTOPT are in H.4.4, “Destination Options” on page 381.

All files that arrive in this queue will be sent to the same Infoprint Manager for AIX Logical Destination and will have the same Destination Options. This method can be used when you have a limited number of destinations with a limited variety in how each file will be handled.

H.1.1.2 SNDTCPSPLF command (LPR)

For greater flexibility in how each file is handled, use the SNDTCPSPLF command and specify the Remote Printer Queue, Destination Options and other parameters as appropriate. Section H.3.3, “Output queue monitor” on page 377, covers how to build a monitor application to automate the selecting of spooled files and setting the parameters for the SNDTCPSPLF command.

Figure 270 on page 370 shows an example of the SNDTCPSPLF command. In this particular example, the spooled file to be sent is DEVTYPE(*SCS). It will be transformed to “flat ASCII” using host print transform and a custom Workstation Customization Object. See H.4.1, “Processing line AS/400 SCS files as ‘flat ASCII’” on page 378, for more information on processing “flat ASCII”. The destination options name the form definition to be used and a file on the AIX system that contains additional processing instructions.

```

Send TCP/IP Spooled File (SNDTCPSPLF)
OR
Send TCP/IP Spooled File (LPR)

Remote system . . . . . RMTSYS      'INFOPRNT'
Printer queue . . . . . PRTQ        'IP60-1'
Spooled file . . . . . FILE         QSYSVRT
Job name . . . . . JOB              DSP01
  User . . . . .                   MIRA
  Number . . . . .                   013140
Spooled file number . . . . . SPLNBR *ONLY
Destination type . . . . . DESTTYP  *OTHER
Transform SCS to ASCII . . . . . TRANSFORM *YES
User data transform . . . . . USRDTATFM *NONE
  Library . . . . .
Manufacturer type and model . . . MFRTPMDL *WSCST
Internet address . . . . . INTNETADR
Workstation customizing object   WSCST
  Library . . . . .                   QUSRSYS
Delete file after sending . . . DLTSPFL *NO
Destination-dependent options . DESTOPT '-of=FLSTD -odatat=line'
-oparmdd=/u/afpres/parmstd132'
Print separator page . . . . . SEPPAGE *YES

```

Figure 270. SNDTCPSPLF or LPR command screen

Using RMTSYS, RMTVRTQ, DESTTYP, TRANSFORM, MFRTPMDL, WSCST, and DESTOPT is the same as using the remote output queue described in H.1.1.1, “Remote Output Queue” on page 367.

- **FILE:** Spooled file. The name of the spooled file to send.
- **JOB:** Job name/user/number. Specify the three components of the Job identifier. In an interactive environment, these values can be retrieved from the WRKSPLF or WRKOUTQ panels and either pressing F11 to see the appropriate view or entering an 8 to view the spooled file attributes. For an automated batch process, see H.3.3, “Output queue monitor” on page 377, for a discussion on the DTAQ (Data Queue) parameter in an Output Queue Description.
- **SPLNBR:** Spooled file number. If there is only one spooled file of a given name in the Job, you can specify *ONLY. Otherwise, specify the exact number or *LAST.

H.1.2 PSF Direct

PSF Direct provides a direct-print connection between an MVS, VSE, VM, or AS/400 system and a printer defined to IBM Infoprint Manager for AIX. PSF Direct gives you control of key print processes from your AS/400 system. An Infoprint actual destination appears to be directly attached to your AS/400 system. Jobs print without delay because they are not spooled by the Infoprint Manager server. Because the AS/400 controls the print process, it returns job-completion and error messages to the AS/400 systems operator.

To use PSF Direct, you need the IBM Communications Server for AIX to communicate between the AS/400 system and AIX. You create printer and APPC definitions on the AS/400 system so that print jobs can be directed to the Infoprint Manager for AIX printer. All spooled data on the AS/400 system is converted to IPDS before being sent to the server.

The printer is defined to IBM Infoprint Control on AIX. A host receiver on AIX passes the IPDS from the AS/400 system to a secondary print process, depending on the connection type and data stream of the destination printer. If the target printer uses the PCL or PPDS data streams, this process will perform the appropriate translation.

After PSF Direct is configured, users or applications can use normal print submission processes to send AS/400 spooled files to the Output Queue corresponding to the PSF Direct printer. PSF/400 automatically directs the output to the PSF Direct server.

Only one host can print to a given device at a time using a PSF Direct. The session needs to be ended or released before you can use the printer for a PSF Direct session from another mainframe or from IBM Infoprint Control. On the AS/400 system, you can use the timer values in the PSF Configuration Object to automatically release the writer from one system so another can use the printer. See the appropriate version of *AS/400e Printer Device Programming*, for more details on sharing IPDS printers. Other PSF hosts have similar timers. See the documentation for each product respectively.

The differences between PSF Direct, using SNA, and printing over TCP/IP are illustrated in Table 46.

Table 46. Differences between PSF Direct, using SNA, and printing over TCP/IP

Function	TCP/IP printing to Infoprint Manager for AIX	PSF Direct
Resources	Must reside on the Infoprint Manager for AIX server.	Reside on AS/400
AS/400 Spooled file types supported.	*SCS (using HPT), *AFPDS, *USERASCII	*SCS, *IPDS, *AFPDS, *LINE, *AFPDSLIN
Output Printer Data Streams supported	Any data stream supported by Infoprint Manager for AIX: IPDS, PCL, PPDS, PostScript (PostScript would only work if it is generated by a user program as a *USERASCII spooled file.)	IPDS, PPDS, PCL4, PCL5, PCL5c
Sharing	Multiple systems may send output to the same printer at the same time. Infoprint Manager for AIX will print according to queue definitions.	Only one Host may print to the printer at one time. Sharing can be set up on a time-out basis using PSFCFG.
Data Stream Conversions	*SCS to "flat ASCII" or PCL is done using HPT on the AS/400 system. This must be explicitly defined in the Remote Output Queue or the SNDTCPSPLF command. All other conversions are done on Infoprint Manager for AIX.	All file types are automatically converted to IPDS by PSF/400 before being sent to the Infoprint Manager server.

Function	TCP/IP printing to Infoprint Manager for AIX	PSF Direct
PSF/400 required	PSF/400 is not required if all AFP printing is done at the server.	Yes
Queue Management	Infoprint Manager for AIX panels or Java GUIs.	Done using AS/400 commands.
Message handling (for example, a paper jam)	Infoprint Manager for AIX panels or Java GUIs; can interface with Network Printer Manager tool for supported printers	Messages are sent to AS/400 Systems Operator
Communication protocol between AS/400 and Infoprint Manager for AIX.	TCP/IP	SNA LU6.2 (printer may be connected to Infoprint Manager for AIX using TCP/IP, Channel, or parallel)

You may want to consider PSF Direct if you do not need dynamic switching between hosts. For example, you print AS/400 “batch” jobs at night using PSF Direct, and during the day, the printer is used by other users. PSF Direct allows you to send *SCS spooled files without conversion to ASCII, and *LINE or *AFPDSLIN, which would not work at all over TCP/IP.

There is currently no single document that offers specific setup instructions for using PSF Direct for AIX with an AS/400 system. The *IBM Infoprint Manager for AIX PSF Direct Network Configuration Guide for System/370*, S544-5486 has information on configuration SNA and the Host Receiver on the AIX system. For the AS/400 system, refer to the configuration samples for SNA printing to PSF/2 in the *IBM AS/400 Printing III*, GG24-4028. Additional information on the AS/400 configuration for PSF Direct can also be found in the *IBM Infoprint Manager for Windows NT*.

The *PSF Direct: AS/400 Configuration* manual written for Infoprint Manager for Windows NT. This manual can be found online at:
<http://www.printers.ibm.com/R5Psc.nsf/web/ntpsfd>

H.2 AS/400 spooled file data streams

The following sections describe the different data streams that can be created as AS/400 spooled files. They also explain how they can be sent to and printed on an Infoprint Manager for AIX server.

H.2.1 *SCS

The default data stream on the AS/400 system is known as SNA Character Stream (SCS). This is an EBCDIC data stream with a minimum of control characters for setting LPI and CPI, for example. This is the data stream generated by system applications such as screen prints, compile listings, job logs, or queries. Many packages from AS/400 software vendors generate SCS.

Infoprint Manager for AIX does not support processing SCS spooled files. You would have to perform one of the following actions to handle them:

- Convert the application to generate *AFPDS.
- Convert the SCS spooled files to “flat ASCII” and then apply a form definition and page definition to format the data.
- Convert the SCS spooled file to PCL.
- Use PSF Direct.

H.2.1.1 Converting to *AFPDS

If you have access to the original application or the printer file for the application, you can change or override the printer files to generate *AFPDS spooled files, which are supported on Infoprint Manager for AIX.

Another option is Advanced Print Utility (APU), a part of PrintSuite for AS/400. APU is designed to re-engineer simple SCS output into sophisticated fully graphical AFP pages. It could be used to convert AS/400 *SCS spooled files to *AFPDS without needing to change the original application.

H.2.1.2 Converting to ‘flat ASCII’ and add form and page definitions

You can use host print transform with a default Workstation Customization object to send *SCS files as “flat ASCII” to Infoprint Manager for AIX. The instructions on how to create the *WSCST are explained in H.4.1.1, “WSCST for ‘flat ASCII’” on page 378. The EBCDIC characters are converted to ASCII, and all control codes are removed except Carriage Return, Line Feed, and New Page. This works best if the applications were generated using Program Defined Printer Files. Externally Defined Printer Files work, but you will lose any controls such as LPI or CPI changes.

To print this file correctly on Infoprint Manager for AIX, the data will have to be matched up with the appropriate form definition and page definition. This can be done using Default Documents on the Infoprint Manager for AIX side, or using the Destination Options of the SNDTCPSPLF Command or Remote Output Queue on the AS/400 system. These alternatives are described in greater detail in the following section.

H.2.1.3 Converting to PCL

In your Remote Output Queue or SNDTCPSPLF command, you can indicate that PCL is to be generated by specifying a Manufacturer Type and Model, such as *IBM4332. This is probably the easiest from a programming point of view, and is most appropriate if the target printer is a PCL printer. If that is the case, you may even choose to print these file to the PCL printer without any additional conversions on Infoprint Manager for AIX. Along with the usual restrictions of host print transform there are other points to consider:

- If the application references printer resident fonts, a font mapping is done, which may or may not match your original document.
- If the spooled file references the front or back overlay, they will not be included. One overlay per document can be added back in using the Destination Options. See H.4.4.2, “Overlays with the SCS file” on page 381.
- Some users are not satisfied with the results of PAGRTT(*COR) or (*AUTO) when using host print transform, because it defaults to 15 cpi instead of 13 cpi.
- If the target printer is ultimately an IPDS printer, this method means you will be translating the spooled file twice, with more chances of fidelity being lost.

- User exit programming may be required on Infoprint Manager for AIX to support multiple drawer selections in PCL.
- Finally, the PCL data stream generated is likely to take much more bandwidth than the corresponding AFPDS or “flat ASCII” file generated using the other two methods listed above.

H.2.1.4 PSF Direct

*SCS spooled files can be sent to an Infoprint Manager for AIX printer using PSF Direct. The spooled files are translated to IPDS by PSF/400.

H.2.2 OV/400 and Final Form Text

Extensions to the SCS data stream, called Final Form Text Document Content Architecture, are used in generating the output of Office Vision/400 (OV/400). There are more controls supported, such as for font selection, line justification, and the ability to include IOCA images. These files cannot be sent “as is” to Infoprint Manager for AIX over TCP/IP. If the file is converted to “flat ASCII”, all formatting controls will be lost. Unless they were extremely predictable, the document cannot likely be recreated using page and form definitions.

One option is to convert OV/400-generated spooled files to PCL. The same restrictions described under *SCS apply.

OV/400 documents can be printed on Infoprint Manager for AIX using PSF Direct.

Note: Support for OV/400 will end in May 2001.

H.2.3 *AFPDS

AFPDS can be generated in a number of ways, including:

- The printer file used by a high level program or system application can be created (or changed or overridden) to use DEVTYPE(*AFPDS).
- APU can be used to convert existing SCS spooled files to AFPDS.
- AFPU/400 (Advanced Function Printing Utilities/400) has a component called Print Format Utility that can generate AFPDS spooled files.
- ERP applications, such as J. D. Edwards OneWorld, can create AFPDS directly from the line-of-business application programs.
- Third-party applications, such as Doc/1 and Custom Statement Formatter, create AFPDS directly.
- PostScript and image print files can be transformed by Image Print Transform (a component of host print transform) into AFPDS.
- ImagePlus and Facsimile Support/400 and other image products produce MODCA-P, which is equivalent to AFPDS.

For the most part, AFPDS spooled files can be sent to Infoprint Manager for AIX over TCP/IP for printing. Use TRANSFORM(*NO) in the Remote Output Queue or the SNDTCPSPLF command. AFP resources will need to be moved to the server and placed in appropriate directories.

There is one very important exception. Many printer files take advantage of Computer Output Reduction (COR) on the AS/400 system, either explicitly with

PAGRTT(*COR) or implicitly with PAGRTT(*AUTO). This includes most system supplied printer files as well as the output generated by many user or vendor programs. The idea is to take output that was normally formatted for the large paper supported on line printers and reduce and rotate it to fit on the smaller paper used by cut-sheet laser printers. Neither *COR nor *AUTO is supported by Infoprint Manager for AIX. If you simply take your SCS printer file and change it to create AFPDS, you will not see the same results when printing through Infoprint Manager for AIX as printing on the AS/400 system. To compensate for this, you would have to explicitly specify in the printer file PAGRTT(90 or 270), FRONT & BACKMGN (.5 .5), FNTCHRSET (a 13 cpi font such as C0D0GT13 or C0620090), and LPI (8 or 9) to have similar results.

You can print all *AFPDS spooled files using PSF Direct. PAGRTT(*AUTO) and (*COR) will be supported. External resources will be managed from the AS/400 system and do not need to be manually transferred to Infoprint Manager for AIX server.

H.2.4 *IPDS

A version of IPDS that is specific to some of the older twinax IPDS printers, such as 3812 and 4224 may be generated on the AS/400 system, and printed without using PSF/400 to some printers. It is not a full implementation of that data stream. Some of the features supported in this data stream are barcodes, printer resident fonts, and embedded IOCA images. Overlays, page segments, host fonts, and other AFP resources are not supported.

This subset of IPDS data stream is not supported on Infoprint Manager for AIX. You cannot send these files to the server that is using TCP/IP. The applications would have to be changed to generate *AFPDS.

You can use PSF Direct to send *IPDS spooled file to the printer via Infoprint Manager for AIX since they are converted to full IPDS by PSF/400.

H.2.5 *LINE or *AFPDSL

PSF/400 has supported *LINE and *AFPDSL (or Mixed) data streams for quite some time. Only recently, it could be generated by standard programming techniques using printer files. Form definitions and page definitions are used to format these types of files. Although Infoprint Manager for AIX also supports Line and Mixed data streams, you cannot send the AS/400 files to Infoprint Manager for AIX using TCP/IP, since the AS/400 system adds some control characters between records, and these are not recognized by Infoprint Manager for AIX.

You can use PSF Direct to send *LINE or *AFPDSL to printers via Infoprint Manager for AIX as they are converted to *IPDS by PSF/400.

H.2.6 *USERASCII

OS/400 does not explicitly generate spooled files that contain ASCII data streams. However, user or vendor applications may generate spooled files that contain ASCII. The AS/400 system does no checking on the validity of the content of those files. Some of the third-party packages use this capability to generate PCL or PostScript. Client Access/400 allows you to generate ASCII data streams on a PC client using an ASCII driver. This output can be placed on the AS/400 Output Queue transparently.

Spooled files that contain *USERASCII may be sent over TCP/IP to Infoprint Manager for AIX. Use TRANSFORM(*NO) when sending these files using TCP/IP.

PSF Direct cannot be used to send *USERASCII files to Infoprint Manager for AIX.

H.3 Automating the process

Depending on the complexity and variety of the applications, there are a few different ways to automate the process of sending the spooled files over TCP/IP and selecting the correct transformation options and processing resources.

H.3.1 Default Document

If all your spooled files use a very limited number of printing characteristics such as data stream type, form and page definitions, etc., you can set up a Logical Destination and Default Document on Infoprint Manager for AIX. In the default document, you name the AFP resources, and you set up the Logical Destination to use that Default Document. On the AS/400 side, you would direct those files needing those resources to that Logical Destination. If you are using AS/400 Remote Output queues, you would need one queue for each Logical Destination.

Assume most of your output from your AS/400 system consists of system generated SCS spooled files that are 132 columns by 66 lines. These are going to be converted to “flat ASCII”, and a form and page definition will be used to format the page. The chain of definitions might look something like the AS/400 Remote Output Queue shown in Figure 271.

```
CRTOUTQ  OUTQ(STD132)
          RMTSYS (INFOPRINT)
          RMTPRTO ('STD132-1')
          CNNTYPE (*IP)
          DESTTYPE (*OTHER)
          MFRTYPMDL (*WSCST)
          WSCST (FLATASCII)
          TEXT ('Remote outq for logical destination STD132-1')
```

Figure 271. AS/400 Remote Outut Queue

On Infoprint Manager for AIX, you would have a Logical Printer that references a Default Document:

```
Logical-Printer-Name = STD132-1
Default-Document    = STD132-dd
```

The Default Document that looks similar to the example in Figure 272 would be created to define the formatting options.

```

Default-document-name           = STD132-dd
Document-format                 = line-data
Resource-context-font           = /usr/lpp/afpfonts
Resource-context-form-definition = /usr/lpp/psf/fontlib
Resource-context-overlay        = /usr/lpp/psf/fontlib
Resource-context-page-definition = /usr/lpp/psf/fontlib
Form-definition                 = F1STD132
Convert-to-ebcdic               = true
page-definition                 = P1STD132
Carriage-control-type          = ansi-ascii
Input-exit                      = /usr/lpp/psf/bin/asciinpe

```

Figure 272. Default document example

H.3.2 Destination options in the remote output queue

Another approach for the one or few formatting combinations is to hard code the appropriate parameters in the Destination Options (DESTOPT) of a Remote Output queue on the AS/400 system.

For the same example, you could use the parameters shown in Figure 273.

```

CRTOUTQ      OUTQ(STD132)
              RMTSYS (INFOPRINT)
              RMTPRTO ('STD132-1')
              CNNTYPE (*IP)
              DESTTYPE (*OTHER)
              MFRTYPMDL (*WSCST)
              WSCST (FLATASCII)
              DESTOPT ('-of=F1STD132 -odatat=line -oparmdd=/u/afpres/parmstd132')
              TEXT ('Remote outq for logical destination STD132-1')

```

Figure 273. Destination Options (DESTOPT) of a Remote Output Queue on the AS/400 system

In the above two methods, you would need one Infoprint Manager for AIX Logical Destination and one AS/400 Remote Output queue for each different application being sent to each printer. For example, if you have two printers and three applications, you would have to set up six AS/400 Remote Output Queues and six Logical Destinations on Infoprint Manager for AIX. For more information, see H.4.4, “Destination Options” on page 381.

H.3.3 Output queue monitor

The final method is to use build an output queue monitor application that watches for files arriving on AS/400 output queues, and then builds the Destination Option string and sets other SNDTCPSPLF parameters on the fly.

The parameter, DTAQ, in the create or change output queue command, allows you to name a data queue. Any time a spooled file is placed in that output queue in a RDY state, or its state changes to RDY, a record is written to the Data Queue with information about that file. A monitor program is set up to receive the data queue records, and takes appropriate action for the spooled file it references.

Depending on the situation, you may need to use a combination of the following elements in your monitor application:

- Lookup tables or files. These can be used to match up the name of the original AS/400 output queue to the target Infoprint Manager for AIX logical destination name, or match up the AS/400 spooled file name or other attribute with a Destination Options string.
- Calls to system API QUSRSPLA to Retrieve Spooled File Attributes. The information retrieved includes information about the spooled file, such as data stream type, page size, overlay name. For more information, see *AS/400 System API Reference*, SC41-3801 or SC41-5801.

A combination of CL and RPG (or other language) may be needed.

Along with the monitor program, a robust system may need some house keeping functions such as error checking and table maintenance. If there is a problem and the monitor needs to be ended, spooled files may have to be held and released in order to put a record back in the data queue.

H.4 Special considerations

The following sections cover several special considerations that you may encounter in your specific implementation of AS/400 to AIX printing.

H.4.1 Processing line AS/400 SCS files as ‘flat ASCII’

There may be times when the you choose to convert the existing AS/400 SCS spooled files to “flat ASCII” and then format them with form and page definitions when they arrive at the Infoprint Manager for AIX server. “Flat ASCII” refers to a simple ASCII file that contains only text and simple line and page controls. The basic steps are:

1. Create a WSCST that converts the spooled file to “flat ASCII”.
2. Create form and page definitions on Infoprint Manager for AIX.
3. Create a “parmdd” file with parameters for the Infoprint Manager for AIX **line2afp** program. The *line2afp* program processes the line data against the form and page definition, producing a fully resolved AFPDS file. Line2afp is an alias for ACIF, AFP Conversion, and Indexing Facility.
4. Send the spooled file from the AS/400 system to Infoprint Manager for AIX using the SNDDTCPSPFL command, or use a Remote Output Queue. You must specify:
 - a. TRANSFORM(*YES)
 - b. MFRTRPMDL(*WSCST)
 - c. WSCST(FLATASCII)
5. Specify Destination Options using the DESTOPT parameter as required, or use a Default Document on Infoprint Manager for AIX.

H.4.1.1 WSCST for ‘flat ASCII’

Here is an example of the source for a Workstation Customization Object used to convert simple SCS spooled files to ASCII. As you can see, only a few of the original SCS controls are converted. Any other controls are dropped. Contrast this to the sample WSCST for IBM4039HP shown in Chapter 6 of *IBM AS/400 Printing IV*, GG24-4389.

```

:WSCST DEVCLASS=TRANSFORM.
:TRANSFRMTBL.
:SPACE
  DATA = '20'X.
:FORMFEED
  DATA = '0C'X.
:LINEFEED
  DATA = '0A'X.
:LPI
  LPI = 8
  DATA = '0D'X.
:EWSCST.

```

The tags for SPACE, FORM-FEED, and LINEFEED are fairly obvious, converting those to the required ASCII equivalents. The LPI tag was inserted to resolve a problem we had at one account that was printing at 8 LPI and had more than 66 lines on the page. HPT was inserting a new form feed after 66 lines by default. This tag eliminated that problem, and has no effect on other spooled files.

To create the WSCST, type the source into a Source Physical File member. The Type field for the member should be blank or *NONE. Use the `CRTWSCST` command to create the object. Here is an example of the command:

```

CRTWSCST WSCST(mylib/FLATASCII)
  SRCMBR(FLATASCII)
  TEXT('Convert SCS to Flat ASCII')
  SRCFILE(mylib/mysrc)

```

This WSCST can now be used in the `SNDCPSPLF` command or in a definition for a Remote Output Queue.

H.4.2 Sample page and form definition for STD132

The most common of the AS/400 spooled files has a record length of 132 and a page length of 66. Figure 274 on page 380 shows a sample of a form definition and page definition source used to format these files once they arrive on Infoprint Manager for AIX. This assumes they have been converted to ASCII using the above FLATASCII Workstation Customization Object.

```

SETUNITS 1 IN 1 IN
        LINESP 8.8 LPI;

FORMDEF STD132
  OFFSET .25 .5
  REPLACE YES;

PAGEDEF STD132
  REPLACE YES
  WIDTH 10 IN HEIGHT 7.5 IN
  DIRECTION DOWN;

FONT CR13 CS 420090 CP V10500;

PRINTLINE CHANNEL 1 REPEAT 66
  FONT CR13
  POSITION MARGIN TOP;
ENDSUBPAGE;

PRINTLINE CHANNEL 1 REPEAT 1 FONT CR13 POSITION 1 MM 1 MM;
PRINTLINE REPEAT 1 FONT CR13 POSITION 1 MM NEXT;
CONDITION TEST
  START 1 LENGTH 1
  WHEN GE X'00' BEFORE SUBPAGE
  CURRENT CURRENT;

```

Figure 274. Sample form and page definition source

The source may be compiled using PPFA on either the AS/400 system or on the Infoprint Manager for AIX system.

When the AS/400 WSCST converts an SCS spooled file to ASCII, it inserts a form feed at the end of every page, including the last page. The CONDITION TEST in the page definition prevents a blank page from being generated.

H.4.3 Parmdd file

The parmdd file may be used to set some of the parameters used by the line2afp program, which converts the “flat ASCII” data to AFPDS. Using a parmdd file is optional. You could specify these parameters in the Destination Options. There is a limit of 132 characters for DESTOPT, so we chose to use a parmdd file. Here is an example of a parmdd file:

```

cc=yes
cctype=z
fdeflib=/u/afp/resources
formdef=f1std132
pdeflib=/u/afp/resources
pagedef=p1std132
inpexit=/usr/lpp/psf/bin/asciinpe

```

The Parameter Descriptions are explained in the following list:

- **Cc=yes or no:** Specifies whether the input file has carriage-control characters.
 - **yes:** The file contains carriage-control characters. “yes” is the default.
 - **no:** The file does not contain carriage-control characters.

Carriage-control characters, if present, are located in the first byte (column) of each line in a document. They are used to control how the line will be formatted (single space, double space, triple space, and so forth). In addition, other carriage-controls can be used to position the line anywhere on the page. If there are no carriage-controls, single spacing is assumed.

- **inpexit=/usr/lpp/psf/bin/asciinpe:** Converts unformatted ASCII data into a record format that contains an American National Standards Institute (ANSI) carriage control character in byte 0 of every record, and then converts the ASCII stream data to EBCDIC stream data.
- **cctype=z:** The file contains ANSI carriage-control characters that are encoded in ASCII. “z” is the default.

For more information on other parameters used in the parmdd file, refer to the section on line2afp in the *IBM Infoprint Manager for AIX Reference*, S544-5475.

H.4.4 Destination Options

Destination Options provide a means to specify how a file being sent from the AS/400 system to a print server is to be processed. For a complete description of all available options, see the *IBM Infoprint Manager for AIX Reference*. The maximum length of the field is 132 characters.

H.4.4.1 Basic SCS spooled file

The DESTOPT parameter to match up an SCS printer file with the STD132 form definition appropriate parmdd file would look something like this example:

```
-of=f1std132 -odatat=line -oparmdd=/u/afpres/parmstd132
```

See the previous section for information on the parmdd file.

The form definition name ends up being specified twice. Once within the parmdd file, where it is used by the line2afp program and again in the Destination Options for use at print time.

These destination options could be hard coded into a Remote Output queue. If you are using the Monitor program described above, you could create a lookup table that selects different Destination Options based on the spooled file name or other parameters.

H.4.4.2 Overlays with the SCS file

If you have an SCS spooled file that references an overlay, the overlay will not be sent (nor any reference to it) if the file is converted to ASCII using host print transform. An overlay reference can be added using the Destination Options. If the overlay name is always the same for given spooled files, you can use a lookup table. If not, for even greater flexibility use the QUSRSPLA API to retrieve spooled file attributes into a program.

The overlay name is added to the Destination Options using the format:

```
-coverlay=myovl
```

In the following example, we check to see if there is a value to OVL, and if so, it is concatenated to the DESTOPT field which will be used subsequently in the SNDTCPSPLF command:

```

IF          COND(&OVL *NE '*NONE')
THEN (CHGVARVAR(&DESTOPT)
      VALUE(&XOPT *BCAT '-overlay=' *CAT &OVL))

```

XOPT contains the base options as in H.4.4.1, “Basic SCS spooled file” on page 381. The overlay specified will print on every page of the document. If you have a different overlay specified as a BACKOVL in your AS/400 spooled file, you may need to build a page definition to handle this. Be aware that this may not be practical for OV/400 documents.

H.4.4.3 User name

If you are using the SNDTCPSPLF command, the user name that is printed on the Infoprint Manager for AIX cover sheet will be the name of the person issuing the SNDTCPSPLF command, not the user who created spooled file on the AS/400 system. If you are using a monitor program, it will be the person who started the monitor job.

To help the users sort their output, use the -userid option in DESTOPT to specify the name, which will show up on the Infoprint Manager for AIX queues and on any cover sheets printed. The monitor program can obtain this value from the information it picks up from the data queue. Here is an example of adding the user name to the destination options (XOPT contains the base options as in H.4.4.1, “Basic SCS spooled file” on page 381):

```

CHGVAR VAR(&DESTOPT) VALUE(&XOPT *BCAT '-userid=' *CAT &USER )

```

This is not a problem if you are using remote output queues. The name of the owner of the spooled file will print on the cover sheet.

H.4.5 Output from the AS/400 query

When a user generates a query report, there is an option to select the form size to print. When the file is printed on an AS/400 attached laser printer, the output could look quite different, depending on the value of width selected.

- If the width is less than 85, the data is printed in portrait format at 10 characters per inch, 6 lines per inch.
- If the width is greater than 85, but less than or equal to 132, the spooled file is generated at 10 cpi, but Computer Output Reduction is invoked, and the result is landscape print at 13.3 cpi, and approximately 8.5 LPI.
- If the width is greater than 132, the spooled file is generated at 15 cpi. Computer Output Reduction is evoked, and the output is converted to 20 cpi.

If the customer desires that the output have similar characteristics when printed via Infoprint Manager for AIX, it takes a little more work than needed for other system generated files. One cannot rely on a simple lookup by spooled file name. The attributes for CPI and WIDTH need to be retrieved using QUSRSPLA to determine the appropriate combination of form and page definitions to use.

H.4.6 Transferring resources

AS/400 overlays and page segments must be converted to a physical file before they can be transferred to AIX. Use the Convert Overlay to Physical File Member (CVTOVLPFM) and the Convert Page Segment to Physical File Member (CVTPAGSPFM) commands, which are included in AFPU/400 (Figure 275).

```

                                Convert Overlay to PFM
Overlay . . . . . : myovl
Library . . . . . : mylib

Type choices, press Enter.

Format of data . . . . . 2          1=Fixed, 2=Continuous
To file . . . . . Myovlpf        Name, *VM, *MVS
Library . . . . . *CURLIB        Name, *CURLIB
To member . . . . . *OVL         Name, *OVL
Text 'description' . . . . . *OVLTXT

Replace . . . . . N              Y=Yes, N=No
Create file . . . . . Y          Y=Yes, N=No
Text 'description' . . . . . Physical file for my overlay

```

Figure 275. Convert Overlay to PFM

Make sure you select option 2 (Continuous) for the Format of data. The Convert Page Segment to PFM has a similar structure.

Transfer the resource to the Infoprint Manager for AIX using FTP. Make sure the file is sent in binary format. Place the resource in a directory that will be found by Infoprint Manager for AIX. See *Infoprint Manager for AIX Reference Manual*, S544-5475, for information on the search order.

H.4.7 Large spooled files

In a couple of cases, customers have experienced problems sending very large spooled files from the AS/400 system to Infoprint Manager for AIX. Smaller spooled files work fine, but when they send large files, they receive error messages TCP3405 and TCP3701, Send Request Failed. No messages are issued on Infoprint Manager for AIX. It was ultimately determined to be a problem with the /var file space on the server side. Have the AIX System Administrator increase the size of this file space.

H.5 Case studies

The following case studies are based on actual Infoprint Manager for AIX customer situations. In some cases, the situations were simplified for emphasis of certain points.

H.5.1 One printer, all AFPDS

This customer had been a faithful user of AFP on the AS/400 system for some time, and most applications had already been formatted with DEVTYPE(*AFPDS). They were adding an Infoprint Manager for AIX server so they could share their large printer with other users.

It was a fairly straightforward task to create one remote output queue to point to the Logical Destination used for the printer. The only destination option used was '-odatat=afpds'. Overlays and page segments had to migrate to Infoprint Manager for AIX.

H.5.2 One printer, four document types

This example was not actually from an AS/400 host, but the situation can apply to the AS/400 system.

This customer was migrating from a non-IBM printer to an IBM AFP Printer. They only had three distinct applications that required special formatting. All the rest was equivalent to STD132 earlier in this chapter.

With the previously installed printer, all the formatting was done at the printer, so it was decided to maintain that philosophy by setting up four remote output queues on the host to point to separate Logical Destinations on Infoprint Manager for AIX, one per application and one for STD132. The rest of the resource selection was to be done based on Default Documents that were associated with the Logical Destinations.

H.5.3 70 printers, 12 applications, SCS spooled files

The customer had a third-party application package that generated SCS spooled files. They were migrating from impact printers using preprinted forms and had about 11 applications with specific formatting requirements for overlays and font changes, along with unformatted system printing. They could not modify the source.

They chose to use form and page definitions to do their formatting. All the AFP resources were created on Infoprint Manager for AIX. Remote output queues with hard coded Destination Options to name resources would not be practical because 1400 would be required for all the valid combinations. A monitor program was written. On the AS/400 system, one (local) output queue was set up for every destination on Infoprint Manager for AIX. Each output queue pointed to one common data queue. The monitor program read the entries from the data queue and used lookup tables to match the name of the application to a Destination Option string, and the name of the AS/400 Output Queue to the name of an Infoprint Manager for AIX Logical Destination. This program also modified the user name as described above.

H.5.4 Multiple printers, many data streams

This customer was installing Infoprint Manager for AIX to share printing between AS/400, MVS, and LAN users on a wide variety of printers over four buildings, ranging from PCL printers to the IBM Infoprint 4000. On the AS/400 system, the applications included:

- Basic system printing STD132
- Query reports of different sizes
- SCS spooled files that had overlays
- OV/400 documents, some of which had overlays
- AFPDS spooled files.

We started with the basic monitor, similar to the one used in the previous example. However, much more logic had to be applied to build the appropriate Destination Options and set the appropriate Transformation parameters in the SNDCPSPLF command. Lookup tables were used to gather general information about each spooled file type, and to match up the target Logical Destination. The QUSRSPLA API was used to gather information such as data stream, if it was generated using Final Form Text Document Content Architecture, query size,

overlay names, and user name. Some files were sent with TRANSFORM(*NO), some with MFRTYPMDL(*HP5SI), and others used the FLATASCII custom *WSCST.

H.6 Sending AS/400 spooled files to OnDemand for UNIX

Automating the process of moving AS/400 spooled files to an AIX platform for loading into OnDemand for UNIX can be accomplished. The degree of automation that you want, as well as the volumes that will be moved, will affect the effort you need to expend to get the job done.

Following is an outline of the tasks required to automatically move financial statements from an AS/400 system to OnDemand for UNIX. IBM Global Services recently completed this work at a number of customer situations, with very satisfactory results.

H.6.1 AS/400 side tasks

You may also want to perform these tasks for the AS/400 system:

- Write a program to monitor for spooled files entering an output queue (see above notes).
- Using the spooled files APIs, open the spooled file object, extract the report data stream, and write it to a stream file in the IFS.
- Write another program that uses the automated FTP functions to send the stream file in the IFS to the AIX server.

H.6.2 AIX side tasks

For AIX, you may want to perform these tasks:

- Write a program which monitors the arrival of the stream file in the designated directory on the server.
- Have the OnDemand load process execute to load the stream file received into the proper Application Group in OnDemand.

While the high level tasks are quite straightforward, the details of the implementation are where you may become overwhelmed. For example, how do you differentiate between different report types, and how do you manage the growth of the addition of new report types over time? Or, how do you handle different data streams that may be created, SCS or AFPDS?

In addition, the degree of automation required will determine how much effort you put into table definitions, error monitoring, reporting, and so on. These are all components of the implementation that add complexity and effort to the overall project.

H.7 AS/400 printing to an Infoprint Manager for Windows NT or 2000 server

Some of the techniques described above for printing to an Infoprint Manager for AIX server also apply to Infoprint Manager for Windows NT or 2000. The remainder of this section will refer to Windows NT, but it also applies to Infoprint Manager for Windows 2000.

Spooled files can be sent from the AS/400 system to the Infoprint Manager for Windows NT server via TCP/IP. This can be done using a Remote Output Queue or the SNDTCPSPLF command, as described in H.1.1.1, “Remote Output Queue” on page 367, and H.1.1.2, “SNDTCPSPLF command (LPR)” on page 369.

PSF Direct is supported from the AS/400 system to Infoprint Manager for Windows NT. There is configuration documentation available on the IBM Printing Systems Division Web site at: <http://www.printers.ibm.com/R5Psc.nsf/web/ntpsfd>

To use PSF Direct, you need the IBM SecureWay Communications Server product to communicate between the AS/400 system and Windows NT.

The considerations presented in H.2, “AS/400 spooled file data streams” on page 372, regarding the different AS/400 spooled file data streams can be applied to sending those same types of files to Infoprint Manager for Windows NT.

Using an Output Queue Monitor in conjunction with Infoprint Manager for Windows NT may still have a use if you want to automate the sending of different spooled file types to different Infoprint Manager for Windows NT logical destinations.

H.7.1 Hypothetical case studies

These scenarios have been verified to work. They are included here to illustrate the possible co-existence between AS/400 and Windows NT for printing.

H.7.1.1 One channel attached printer, two hosts

A customer currently has an IBM 3900-001 printer attached via parallel channel to a PSF/2 server, using Distributed Print Function (DPF). There are two AS/400 hosts sending data to the printer. The customer wants to move to a Windows NT solution. Infoprint Manager for Windows NT does not support DPF. Consequently, the customer will use PSF Direct and set up the PSF Configuration Objects on each AS/400 system so that the printer session will time out if there are no spooled files ready.

H.7.1.2 Two printers, three applications

A customer wants to use Infoprint Manager for Windows NT to share their two medium-speed printers with the AS/400 system and other LAN users. The AS/400 applications consists of invoices and statements that are already in AFPDS format, and other SCS printing generated using the default system printer files. They plan on using the STD132 form and page definitions as described in H.4.2, “Sample page and form definition for STD132” on page 379.

This customer will set up four remote output queues on the AS/400 system. Two of these will be for the AFPDS spooled file that are to print on each of the two printers. These output queues will have TRANSFORM(*NO) specified. The target logical destinations will reference a default document that is set up for printing AFPDS by specifying:

```
document-format=afpds
```

Two other AS/400 output queues will be set up to handle the default system printing. They will be setup with TRANSFORM(*YES) and use the “Flat ASCII” Workstation Customization Object as described in H.4.1.1, “WSCST for ‘flat ASCII’” on page 378. They will point to two logical destinations that use a default

document for printing that is similar to the one described in H.3.1, “Default Document” on page 376.

H.8 Additional references

For more information, please refer to the following publications:

- *AS/400e Printer Device Programming Version 4*, SC41-5713
- *Infoprint Manager for AIX Reference*, S544-5475
- *IBM Infoprint Manager for AIX PSF Direct: Network Configuration Guide for System/370*, S544-5486
- *IBM AS/400 Printing III*, GG24-4028
- *AS/400e System API Reference Version 4*, SC41-5801
- *IBM AS/400 Printing IV*, GG24-4389
- *Windows NT PSF Direct: AS/400 Configuration*

Appendix I. Infoprint 2000 printing considerations

The announcement of the IBM Infoprint 2000 Multifunctional Production System, Models RP1, NP1, and DP1 with its high speed cut sheet printing and duplicating did not provide a robust AS/400 print solution. The data streams supported initially are PostScript 3, PDF, PCL6 and LCDS/Metacode. The AS/400 system provides direct connection only via a remote outqueue and the use of the host print transform (HPT) functions as described in Chapter 6, "Host print transform" on page 137. The use of an intermediate system, such as the IBM Infoprint Manager AIX and other third-party solutions, also allows AS/400 spool output to be printed on the Infoprint 2000. An IPDS version of the DP1 model will be offered at a later date, supporting the Advanced Function Presentation architecture's Intelligent Printer Data Stream.

Many of the installations of the Infoprint 2000 are for reprographics and network printing applications and the amount of print from the AS/400 system represents a small percentage of the total print workload. Other installations have been for specific applications that have used customized HPT or intermediate solutions. The following sections look at the considerations for print files and HPT and the use of an intermediate solution for application formatting.

Note: The IPDS version of IBM Infoprint 2000 was announced in September 2000.

I.1 Print file considerations and HPT formatting

Printing directly from the AS/400 system to the Infoprint 2000 can result in many challenges and require changes in the operations procedures. The AS/400 spool output (Data Type=*SCS and *AFPDS only) must be converted into ASCII. A supplied or custom HPT will be used. The AS/400 HPT objects will create ASCII data streams for PCL, pure ASCII or image. One or more of these HPTs may be used to provide optimum results. If a HPT is being used today for other ASCII printers that support PCL, then the results should be identical. If twinax attached printers or AFP printers are being used, differences and limitations may apply.

The remote print writer (STRRMTWTR) is an automated LPR to the printer queue. Some of the limitations of the HPT and remote writers are:

- No Forms mount messages (ignored)
- No Page Range printing (unsupported program is available)
- Copies are transmitted individually (XAIX parameter in the outqueue)
- No multi-up support
- SCS and AFPDS data types only supported (*USERASCII is passed through)
- DDS functions, such as scale and rotate of page segments, are not supported
- Draw commands that print in the 'no print borders' will be adjusted into the print area

The primary output of AS/400 applications are business oriented, for example Invoices, Packing List, Labels (with barcodes), reports, and so on. The unique functions of Infoprint 2000, like the production of booklets and other output formats produced by PC and network applications, are not usually necessary.

Therefore, the primary objective will be to produce business output on Infoprint 2000 at a rated speed, meeting the business objectives of the organization.

One requirement that has been and will remain important is maintaining the integrity of the printed page. Printing on Infoprint 2000, a local network printer or an AFP Printer should provide similar results. The fonts should be mapped, boxes and lines appear in the same place, graphic objects reproduced accurately, and so on. The differences that exist in the hardware and software technology may not map one to one. Therefore, content integrity is the default. The objective is to minimize the differences.

The print management functions that can be specified in the Print File using the CHGPRTF, OVRPRTF, and CRTPRTF commands and the function of the native print writer give the application developer control over the printing process. Many of these print file parameters are ignored by the AS/400 HPT processing of the Remote Writer. For example, jobs that have an overlay specified in the print file to merge SCS output with a form, will ignore the overlay, printing the data not the form. Overlays and Page Segments referenced in the DDS (externally described print file) of *AFPDS output will be processed and converted.

Customization of the HPT table may be necessary to specify input and output options on the printer. We recommend that you use the latest printer microcode. Understanding the PCL data stream is necessary if special functions are to be implemented. Infoprint 2000 will honor the PCL drawer selections with the Release 3.0 Version 3.15 of the printer microcode.

Control of SCS and IPDS printers have allowed jobs with different characteristics to be sent to the same output queue. The AS/400 writer would assist in managing the workflow with operator messages, workload balancing, and so on. With the Remote Print Writer and HPT, it may be necessary to create many output queues, one for each job characteristic that will be coded in a unique HPT. In many accounts, this will require additional operator instructions or changes to current instructions that will place job print integrity on the operator. One of the restrictions encountered in early installations was the use of simplex and duplex printing on pre-punched paper. The 3130 and 3160s used by the account had edge sensitivity and would rotate the pages for proper printing. This now requires planning of drawers for simplex and duplex, and the input bin changed in the print file. The HPT object used or customized will need to send the correct escape sequence for that drawer.

Custom HPT information is provided in Chapter 6 of this manual. Additional HPT information is available on the AS/400 Web site in Rochester. The knowledge base under the category of Print has setup, customization, and PTF information. Information provided includes remote print writer considerations, the page range program, TCP/IP printing, and HPT customization.

I.2 Infoprint Manager and other solutions

The use of a print solution other than the native AS/400 writers has been an option for years. Many of these solutions can be applied to printing from the AS/400 system to the Infoprint 2000. IBM Infoprint Manager has been used for printing of AFPDS on the printer. All of the necessary AFP resources are loaded into the AIX system as described in Chapter 2 of *AS/400 Printing IV*, GG24-4389. Overlays, page segments, and fonts are then processed by Infoprint Manager and

delivered to the printer. Operator control of the printing is moved from the AS/400 system to the Infoprint Manager system. With Infoprint Manager, printing control is robust.

Some of the other solutions for formatting spooled files that can be used are applications like Create!Print, Planet Press, and so on. These solutions either interface with the AS/400 spool and create USERASCII output on the AS/400 system or rely on the AS/400 system to provide a trigger on the front of the document that will invoke a PostScript Macro on the printer to format the data.

The processing of the SCS spooled files into ASCII with a trigger that will invoke the PostScript application will require either AS/400 application modification and the use of the *WSCSTNONE transform or a custom HPT that will add the trigger to an existing application's spooled file. If multiple trigger applications are needed, each will require a customized WSCST and its own outqueue.

The system supplied host print transform for outputting ASCII is the *WSCSTNONE transform. To create a custom WSCST with a trigger requires the retrieval and modification of a HPT that outputs ASCII. The retrieval of the ASCII HPT and the modification of the HPT are the initial sequence to invoke the PostScript trigger application.

The WSCST source that was retrieved (RTVWSCST) from the IBM provided ASCII HPT (*WSCSTNONE) is shown in the example in Figure 276.

```

Columns . . . : 1 71          Browse          AGROSE/QIXTISRC
SEU==>          ASCII
FMT **  ...+... 1 ...+... 2 ...+... 3 ...+... 4 ...+... 5 ...+... 6 ...+... 7
***** Beginning of data *****
0000.01 :WSCST DEVCLASS=TRANSFORM.
0000.02
0000.03      :TRNSFRMTBL.
0000.04      :INITPRT
0000.05      DATA ='00'X.
0000.06      :SPACE
0000.07      DATA ='20'X.
0000.08      :CARRIN
0000.09      DATA ='0D'X.
0000.10      :FORMFEED
0000.11      DATA ='0C'X.
0000.12      :LINEFEED
0000.13      DATA ='0A'X.
0000.14 :EWSCST.
***** End of data *****

```

Figure 276. WSCST source

The trigger required by this application was the insertion of a cover page containing the form name on the front of the spooled file. To do this, we modify the initial printer sequence sent to the printer by the host print transform in the print writer. The ASCII hex value was determined for the form name, and the hex value '0C' is the form feed or page eject. Line 5 of the WSCST source above was changed from a hex value of '00' to the ASCII value for trigger name, HRFORM1, followed by a form feed of hex '0C'. The value became DATA ='4852464F524D310C'X. This custom HPT was then saved and compiled using the CRTWSCST command and added to the remote outqueue description (WRKOUTQD). Every job that is processed through this outqueue will arrive at

the printer as pure ASCII and have a header page with the word HRFORM1 as its only content. All other printer file values specified, such as cpi, font, simplex, duplex, etc., are ignored.

The revised customization object is shown (Figure 277) and is compiled using the CRTWSCST command.

```

Columns . . . : 1 71          Browse          AGROSE/QITXSRC
SEU==>          ASCII
FMT **  ...+... 1 ...+... 2 ...+... 3 ...+... 4 ...+... 5 ...+... 6 ...+... 7
***** Beginning of data *****
0000.01 :WSCST DEVCLASS=TRANSFORM.
0000.02
0000.03 :TRNSFRMTBL.
0000.04 :INITPRT
0000.05 DATA ='4852464F524D310C'X.
0000.06 :SPACE
0000.07 DATA ='20'X.
0000.08 :CARTIN
0000.09 DATA ='0D'X.
0000.10 :FORMFEED
0000.11 DATA ='0C'X.
0000.12 :LINEFEED
0000.13 DATA ='0A'X.
0000.14 :EWSCST.
***** End of data *****

```

Figure 277. Revised customization list

1.2.1 Another application solution

The controller for the Infoprint 2000 Reprographics System can be modified to provide additional application flexibility. In one installation, a shareware PostScript macro was used to produce two-up on the printer. The technique is similar to the trigger application. The PostScript shareware was installed on the printer controller, and a monitor was invoked to scan the input stream for the processing options supported. Since two-up could be either simplex or duplex, additional WSCST tags were used on the HPT. They processed specific print file attribute and imbedded keyword triggers in the beginning of the spooled file sent to the printer. The tags for simplex, duplex, and tumble printing were added to the *WSCSTNONE retrieved object.

The AS/400 spooled file could specify simplex, duplex, or duplex tumble for the output. Printing on three hole paper requires that the holes be on different sides in the input drawers for simplex and duplex. Logic was also added to the scan program to submit the print job to use the correct drawer. The following lines were added after line 13 to the unmodified WSCST above:

```

0000.14 :SMPXPRT
0000.15 DATA ='53494D504C45580A'X.
0000.16 :DUPXPRT
0000.17 DATA ='4455504C45580A'X.
0000.18 :DUPXPRT
0000.19 DATA ='54554D424C450A'X.

```

The result was an ASCII file arriving in Infoprint 2000 with three additional lines of data added to the beginning of the ASCII spooled file, with the value in the third line being the trigger for the two-up application with logic to choose drawers

based on the physical paper orientation needed for printing simplex and duplex two-up.

Note that pure ASCII and PCL, should not be mixed within a file. The PCL escape sequences will be treated as data once the printer decides that the data stream is not PCL.

Each of these solutions requires a knowledge of the data stream provided by the AS/400 system, the impact of the HPT on document integrity, and the application capability of any intermediate system. Placing shareware into the printer controller also requires UNIX knowledge. Each of these solutions has strengths and weaknesses and may be a custom installation.

I.2.2 Operator considerations

The current procedures used for operations control may need to be modified, often significantly, to insure print integrity. Print jobs may need to be modified to direct them to the new queue or operator procedures may need to be updated if the operators moved jobs from a job queue to the printer device queue. Any job where print file attributes are ignored, need to be handled as an exception and may require a unique output queue. If the job is moved into the incorrect queue, there is no checking of the data, and it is possible to experience a higher number of print errors and reprints.

Additional reasons for multiple PCL queues may be the need to modify rotation to force portrait for applications where there is no source or the print file cannot be modified. Special line spacing is often desired for Computer Output Reduction (COR) to better fit the page or to offset for prepunched paper, functions that could be handled automatically by the PSF/400 writer. Each exception needs to be documented, and training needs to be provided for increased operator training.

Page restart integrity now is an operator task with the remote outqueue. For example, if it was necessary to restart a print job on an AS/400 system attached 3130 Printer, the PSF/400 writer would determine the exact page to restart based on the position on the page. A two-up duplex job actually contains four logical pages. If a jam occurred while printing pages 17 through 20, the AS/400 system would resend beginning at page 17. The page restart for the remote outqueue does not consider page position because the multi-up is done by the printer, allowing resending at any page number.

Since the AS/400 system assumes at once LPR is complete, the job has printed, the disposition of print jobs may need to be set to SAVE=*YES. This allows the resending of jobs.

Appendix J. Printing enhancements in recent OS/400 releases

This appendix summarizes the enhancements in OS/400, Print Services Facility/400 (PSF/400), and related printing software in the last four releases—V4R2 through V4R5.

J.1 Version 4 Release 5

Version 4 Release 5 includes the following enhancements:

- SNMP ASCII Printer Driver OS/400
- SNMP ASCII Printer Driver for IBM Infoprint 21
- Expanded printer speed ranges for PSF/400
- Type Transformer for Windows

Another enhancement in the V4R5 time frame, but not part of the release, is AFPDS/IPDS support for OneWorld, an ERP e-business solution from J. D. Edwards.

J.1.1 SNMP ASCII printer driver

The Simple Network Management Protocol (SNMP) ASCII Printer Driver is a new printer driver for TCP/IP attached printers. This printer driver provides the function found in the PJI printer driver but does not require the printer to support PJI commands. With the SNMP printer driver, there are now three ASCII printer drivers:

- LPR, or remote output queue
- PJI printer driver
- SNMP printer driver

See 11.2.3, “Configuring LAN-attached ASCII printers using SNMP drivers” on page 246, for more information.

J.1.2 SNMP driver for Infoprint 21

A special version of the SNMP printer driver is provided for IBM Infoprint 21. IBM Infoprint 21 is a new generation network printer for the AS/400 system. It is the first IBM AS/400 printer to use the IBM Homerun controller. The Homerun controller is designed with the capabilities of the IBM Advanced Function Common Controller Unit (AFCCU), the standard controller for high-speed printers) but geared for lower-speed network printers. The spooling design incorporated within the Homerun controller greatly enhances print performance in a network environment. However, there can be incompatibilities when using the PJI printer driver. The SNMP ASCII printer driver is the recommended printer driver for Infoprint 21. Support for the SNMP printer driver for Infoprint 21 is also available for V4R3 and V4R4 via a PTF.

The SNMP printer driver is only needed when Infoprint 21 is used as a PCL printer. When used as an Intelligence Printer Data Stream (IPDS) printer, then PSF/400 is the printer driver.

J.1.3 PSF/400 printer ranges

PSF/400 is licensed by printer speed ranges. Each licensed speed range enables an unlimited number of printers (for the licensed AS/400 system) within that range. With V4R5, the printer speed ranges have been expanded as follows:

- 1 to 28 pages per minute
- 1 to 45 pages per minute
- Any speed (1 to unlimited pages per minute)

J.1.4 AFP Font Collection bundled with PSF/400

AFP Font Collection, the comprehensive set of AFP fonts for the AS/400 system (and other servers), is now bundled with new orders of PSF/400 (beginning with V4R5).

J.1.5 Type Transformer for Windows

Type Transformer for Windows, a font conversion and editing platform, became available in June 2000. Type Transform for Windows, a feature of AFP Font Collection (5648-B45), enables conversion of Adobe and TrueType fonts to AFP fonts for use with AS/400 print and presentation applications. Type Transformer also includes utilities for editing individual font characters and for editing code pages.

For details on Type Transformer for Windows, see 4.11, "Creating AFP fonts with Type Transformer" on page 110.

J.1.6 AFP/IPDS support for OneWorld

OneWorld, a leading ERP software solution from J. D. Edwards, now has integrated support for AFPDS/IPDS. This support shipped in October 2000 with OneWorld Xe. With this support, any OneWorld application output can be created in either AFP or PDF format.

J.2 Version 4 Release 4

The following AS/400 program products have been enhanced with this new release:

- | | |
|---|----------|
| • OS/400 | 5769-SS1 |
| • Print Services Facility/400 (a feature of OS/400) | 5769-SS1 |
| • Advanced Function Printing Utilities for AS/400 | 5769-AF1 |
| • AFP Font Collection | 5648-B45 |
| • Content Manager OnDemand for AS/400 | 5769-RD1 |

The new DDS keywords support these features:

- Switch between simplex and duplex printing within a spooled file
- Force printing on a new sheet of paper anywhere in a spooled file
- Direct selected pages of a spooled file to a specific output bin
- Tabbed insert pages from a finisher anywhere within an output file
- Specify z-fold options for any page within an output file
- Include an overlay and specify the orientation (rotation) at which the overlay should be printed

New printer file functions include:

- Print overlays on the back side of pages without any variable data
- Specify that output should be corner-stapled, edge-stitched, or saddle-stitched as a printer file option.

J.2.1 Simplex/duplex mode switching DDS

This DDS keyword allows you to switch back and forth between simplex and duplex mode when printing. This is useful when parts of a job should be simplex and other parts should be duplex. Setting the proper mode can improve job throughput.

J.2.2 Force new sheet DDS

When printing in duplex mode, the Force new sheet DDS keyword provides control of the sheet in addition to the side. Execution of this keyword forces a new sheet to be selected regardless of whether you are currently on the front side or back side of the sheet in process.

J.2.3 Output bin DDS

This keyword enables DDS-level (for example, page level) control of output bin. Prior to this support, all pages in a spooled file went to the output bin defined in the printer file.

J.2.4 Insert DDS

As part of the finishing options added during the V4 releases, the insert DDS keyword enables insertion of a sheet from the inserter (for example, as found on the Infoprint 60 finisher) within the current print job. This provides for inclusion of such booklet inserts as cover sheets, back pages, and tab sections.

J.2.5 Z-fold DDS

Certain output finishers (for example, the Infoprint 60 finisher) support the z-fold operation. This operation takes an 11 by 17 inch page (for example, spreadsheet) and “z-folds” it down to 8 ½ by 11 inch size. This is handy to include large format pages in a standard size booklet.

J.2.6 Overlay rotation DDS

This DDS parameter for the OVERLAY keyword provides the capability to change the orientation of overlays on the page. This avoids the need to have the same overlay stored multiple times in different orientations.

J.2.7 Constant back overlay in the printer file

A new printer file keyword provides the capability to print an overlay on the back side (duplex side) of a sheet without application data. This capability is useful in any application where application data is to be printed on the front side and static data on the back side. An example would be a customer invoice where the back side of the sheet has static terms and condition information that is put there as an overlay.

J.2.8 Print finishing

Support for stapling options, initially supported in V4R2, is now added directly to the printer file. CORNERSTPL, EDGESTITCH, and SADLSTITCH are the keywords. For example, CORNERSTITCH(*TOPLEFT) causes the print job to staple in the top left corner of the page. The function selected must be supported on the specified printer (for example, Infoprint 32, Infoprint 40, Infoprint 60).

J.2.9 AS/400 font management

AS/400 applications can use both AS/400-resident and printer-resident fonts. The mapping table that manages font selection and substitution is now user-modifiable using the PSF configuration object. This enables you to control font fidelity for your applications across a variety of different printers with greater flexibility and precision.

J.2.10 Advanced Function Printing Utilities (AFPU) enhancements

AFPU provides a set of supporting functions for advanced output applications, including electronic form design and management of forms and images. Enhancements with V4R4 include new barcode symbol, color support, and improved image handling.

J.2.11 Content Manager OnDemand for AS/400

Content Manager OnDemand is a comprehensive archival system for the AS/400 system. It supports the organization, indexing, storage, retrieval, viewing, faxing, printing, and network presentation of AS/400 documents, reports, and other objects. V4R4 implements the OnDemand user interface into Operations Navigator. In addition, OnDemand is now integrated with EDMSuite ContentConnect, which provides Web access across multiple document repositories. Web access is provided by NetConnect.

J.3 OS/400 Version 4 Release 3

In OS/400 Version 4 Release 3, Print Services Facility/400 and associated native OS/400 print support (Printer File and DDS) have been enhanced. They provide new application capabilities and take advantage of new printers and printer attachments. These enhancements include:

- Integration of AFP Workbench into Client Access/400
- DDS indexing keyword to support for archiving and viewing applications
- Support for line data formatting enhanced
- Automatic resolution enhancement
- Font performance improvement reduces CPU utilization
- Sizing and rotation for page segments
- Enhanced PostScript transform
- IPDS Pass-through
- Enhanced AFP Font Collection with support for euro, expanded languages
- Availability of new versions of Advanced Print Utility, Page Printer Formatting Aid, AFP Toolbox, and SAP R/3 AFP Print (members of the AFP PrintSuite family)

These are explained in greater detail in the following sections.

J.3.1 Integration of AFP Workbench into Client Access/400

Functions in the AFP Workbench that had previously been an optional, priced feature of Client Access/400 are now integrated as part of the product. Client Access/400 (CA/400) users can now view any document on their PC or in a CA/400 shared folder that is in AFP, ASCII, TIFF, PCX, DCX, or DIB data format. They can also use AFP Workbench Viewer to create page segments (images) or overlays (electronic forms) from any PC application program and upload them to OS/400 for printing with OS/400 applications. This AFP Printer Driver for Windows can also be downloaded from the Web site at:

<http://www.ibm.com/printers/as400>

For additional details, see Chapter 5, “The IBM AFP Printer Driver” on page 117.

J.3.2 Indexing keyword in DDS

The AFP presentation architecture includes support for indexing fields in a print record to be used for navigation by an archival/retrieval program, or by a document viewing or browsing program (such as the AFP Viewer in CA/400). In Version 4 Release 3, Data Description Specifications (DDS) has been enhanced to enable specification of fields in a record as AFP index fields. Output from these applications can now be used with archival/retrieval programs for fast retrieval of individual pages or groups of pages in the archive. Archival programs that use AFP index fields include IBM Content Manager/OnDemand for AS/400, OnDemand for AIX, and OnDemand for NT. OnDemand for AS/400 was formerly named RDARS/400. The AFP Viewer in CA/400 also supports using index information in documents to quickly locate any group of pages within a spooled file, PC file, or shared folder.

J.3.3 Support for line data enhanced

Support for generating line data from AS/400 applications and using page and form definitions to format output external to the application program was introduced in Version 3 Releases 2 and 7. However, many applications from third-party vendors, as well as customer applications, could not take advantage of this powerful new formatting capability because they were already formatted using DDS (although the DDS specifications were simple). In Version 4 Release 3, new OS/400 system function has been provided to automatically convert output from programs that use DDS into line data so that they can be formatted using all the capabilities of AFP page definitions and form definitions objects. Page and form definitions are created using Page Printer Formatting Aid (PPFA/400) or similar products. PPFA/400 is a component of the AFP PrintSuite for AS/400. See Chapter 3, “Enhancing your output” on page 67, for more information on formatting application output with PPFA/400.

J.3.4 Automatic resolution enhancement

Many current IBM AS/400 IPDS printers print at a resolution of 600 dpi. However, applications may have been developed to use raster fonts in 240 dpi or 300 dpi resolutions. New multiple resolution font support in OS/400 Version 4 Release 3 provides the capability for these applications to take advantage of the increased print quality of new printers without application or resource changes. PSF/400 will coordinate with the printer to download the best resolution to enable the printer to render a requested font at 600 dpi.

Note that resolution enhancement applies to fonts. For images, page segments that are in Image Object Content Architecture (IOCA) are resolution-independent and will be rendered at the resolution of the target printer. For older page segments that use the IM1 format, those are converted to IOCA when possible. When such a conversion is not possible, the image is rendered “as is”. This will result in a change in the size of the image if the IM1 resolution and the printer resolution are different.

J.3.5 Font performance improvement

For applications that use AFP fonts downloaded to a printer that supports both raster and outline fonts, a performance enhancement in OS/400 V4R3 can result in a reduction in CPU utilization of 50 to 70%. This represents a significant improvement in system performance for customers who print on IBM high-speed AFP printers, or for customers running mid- to high-speed printers on a CPU-constrained system.

J.3.6 Sizing and rotating page segments

Support for page segments (image objects) has been enhanced with new DDS options for dynamic sizing and rotation. This allows you to create one page segment (a company logo, for example) and dynamically size or rotate it based on the needs of each different print application. Previously, a separate page segment object was required for every size and rotation required across all of your printing applications. With this support, only one version of an image is required. The rotation and scaling of page segment images is done in the printer. Therefore, only certain printers are supported (those with printer controllers).

J.3.7 Enhanced PostScript transform

The transformation of PostScript files, part of Image Print Transform services included in V4R2, is enhanced to provide Double-Byte Character Set (DBCS) support. Using this support enables PostScript files to be transformed to AFPDS or PCL and routed to either AFP or PCL printers.

This PostScript transform handles all PostScript L1 functions and some of PostScript L2 functions. See Chapter 7, “Image print transform” on page 161, for information on Image Print Transform.

J.3.8 IPDS pass through

IPDS pass through is now a standard printer file parameter. With IPDS pass-through, you can significantly increase overall printing performance to IPDS printers for print files not requiring advanced IPDS services. See Appendix A, “PSF/400 performance factors” on page 279, for more information on IPDS pass-through.

J.3.9 AFP Font Collection with Euro, expanded languages

AFP Font Collection (program 5648-B45), the one-stop resource for AFP fonts, has been repackaged. It now includes support for additional languages and support for the euro currency symbol. AFP Font Collection is a comprehensive set of AFP fonts with over 1,000 fonts from the most popular type families. Such family examples include Times New Roman, Helvetica, and Courier. These fonts come in a full range of sizes, resolutions (240, 300, and outlines), and languages

(over 48). See Chapter 4, “Fonts” on page 89, for additional information on AFP Font Collection.

J.3.10 AFP PrintSuite for AS/400

AFP PrintSuite for AS/400 is a family of products for formatting application output into advanced electronic documents. This family includes:

- Advanced Print Utility (APU)
- Page Printer Formatting Aid/400 (PPFA/400)
- AFP Toolbox for AS/400
- SAP R/3 AFP Print

Each of these electronic document products was enhanced with new versions in May 1998 (V3R7M1).

For additional details on the changes to APU, see Chapter 2, “Advanced Function Presentation” on page 35.

J.4 OS/400 Version 4 Release 2

Changes in V4R2 include:

- OS/400 V4R2, including Image Print Transform services
- Print Services Facility/400 V4R2, including PostScript support, outline fonts, font capture, cut sheet emulation, and finishing
- AFP Utilities V4R2, with enhancements to electronic form creation on the AS/400 system
- New and revised guides to AS/400 printing include this redbook and *AS/400 Guide to Advanced Function Presentation and Print Services Facility* S544-5319.

J.4.1 OS/400 Image Print Transform Services

OS/400 adds a new subsystem to support documents and files in PostScript print format as well as the TIFF, GIF, and BMP image file formats. These are common formats found in network applications. This new subsystem, called Image Print Transform, will transform those input formats into AFP, PCL, or PostScript format. These transforms are invoked automatically as part of the normal print process or invoked through an API as a standalone process.

Let's look at the automatic process first. An application, such as one running on a CA/400 client or the IBM Network Station, generates a PostScript file to an AS/400 output queue. If a writer is started to that queue going to an IPDS printer, then PSF/400 will take control. When it starts to process the PostScript file, it passes control to the Image Print Transform subsystem to convert the PostScript to AFP. The Image Print Transform, in turn, uses a new object—the Image Configuration Object—to provide additional information on how to do the conversion. The converted AFP is passed back to PSF/400, which sends it out (as an Intelligent Printer Data Stream) to the printer.

The automatic process could also be routed to a PCL printer. In this case, host print transform would receive the PCL data stream from Image Print Transform services and send it on to a PCL printer.

The Image Print Transform process can also be run via an API. Here, the input files might reside on the IFS file system. The API can be run to convert the file formats to memory, to another file, or to an output queue. For example, you may want to “preprocess” a PostScript file to AFP prior to putting it on the output queue to speed up the printing process.

In addition, there are also non-print applications that may require the kind of transform services provided by this new subsystem.

These new transform services add to the transform facilities already provided by the AS/400 system:

- AFP to PCL
- AFP to TIFF
- SCS to ASCII
- SCS to TIFF

See Chapter 7, “Image print transform” on page 161, for more information about Image Print Transform.

J.4.2 Support for outline fonts

Outline fonts are now supported on the AS/400 system. Outline fonts are familiar to PC users because they are standard with TrueType and Adobe Type 1 fonts. To date, the AS/400 system has only supported raster (also known as bitmapped) fonts. With raster fonts, each character in each font, in each point size, is an image. All of these images are stored on the AS/400 system (as entries in a font character set object). They are downloaded to the printer when they are referenced in an application. In contrast, outline fonts are vector representations of a font. There is only one small object required for all point sizes. Any point size can be selected, as compared to a limited number of sizes with raster fonts. Both AS/400-resident outline fonts (available through AFP Font Collection, for example) and printer-resident outline fonts are supported. Outline fonts improve printing performance, require less printer memory, and provide unlimited size selections.

J.4.3 Font capture

Font capture is a font performance enhancement that retains (“captures”) a font on the printer hard drive. Font capture has a significant impact when the connection to the printer is slow or when large Double Byte Character Set (DBCS) fonts are used. DBCS fonts are graphic-type fonts used in indeographic languages such as Japanese and Chinese. Font capture also has an impact with Single Byte Character Set (SBCS) fonts, but it may be less.

J.4.4 Cut-sheet emulation

Cut-sheet emulation ensures that duplex applications, created for cut-sheet printers, print correctly on two-up duplex production printers (such as the Infoprint 4000 production printer family). The output from continuous-form production printers (after the forms have been sliced in two and interleaved by postprocessing) is identical to the output from a cut-sheet duplex printer. This capability allows you to easily take advantage of the increased speed and reliability of continuous form printers without changing your operating procedures or programs.

J.4.5 Finishing support

Initial finishing support was added in V4R2. This support included:

- Edge stapling
- Corner stapling
- Saddle stitch
- Insert
- Z-fold

Edge, corner, and saddle stitching were added to the printer file using the USRDFNDATA keyword. The syntax for the USRDFNDATA keyword is:

```
'CORNERSTPL (*TOPLEFT) '
```

Insertion and z-fold (as well as the stapling and stitching options) were added to the AS/400 page and form definitions. PPFA/400 or other similar tools for building AS/400 page and form definitions could be used to enable these functions.

Certain finishing operations require a combination of DDS and the form definition (at V4R2). These functions were integrated in DDS and the printer file at V4R4. See J.2, “Version 4 Release 4” on page 396, for the current support for finishing.

J.4.6 TCP/IP configuration enhancements

Several changes were made to the session management of TCP-IP connected IPDS printers. With the Automatic Session Recovery keyword (AUTOSSNRCY), you can specify if you want PSF/400 to automatically reconnect on a TCP/IP network error. With the acknowledgment frequency keyword (ACTFRQ), you can set how often to query the printer for the updated page counter. A high frequency setting minimizes the number of reprinted pages on a network error, but may reduce performance slightly.

The remote location name, port, and activation timer were removed from the PSF configuration object (PSFCFGOBJ). These keywords were moved to the printer device description.

J.4.7 Font substitution messages

A new parameter in the PSF Configuration Object provides control over whether font substitution messages are logged to the message queue. See Appendix 11.1.2, “Configuring LAN-attached IPDS printers on V3R7 and later” on page 230, for more information.

J.4.8 AFP Utilities for V4R2

AFP Utilities is a set of three supporting utilities for AFP applications on the AS/400 system. The Overlay Utility allows you to create electronic forms from any AS/400 terminal. The Print Format Utility is an AFP version of Query/400. It creates AFP applications directly from AS/400 database files. Resource Management Utility enables you to manage overlay and image resources on the AS/400 system. For details on V4R2 enhancements, see 2.3, “AFP Utilities/400 V4R2 enhancements” on page 45.

Appendix K. Using the additional material

This redbook also contains additional Web material. See the appropriate section below for instructions on using or downloading this material.

K.1 Locating the additional material on the Internet

The CD-ROM, diskette, or Web material associated with this redbook is also available in softcopy on the Internet from the IBM Redbooks Web server. Point your Web browser to:

<ftp://www.redbooks.ibm.com/redbooks/SG242160>

Alternatively, you can go to the IBM Redbooks Web site at:

ibm.com/redbooks

Select the **Additional materials** and open the directory that corresponds with the redbook form number.

K.2 Using the Web material

The additional Web material that accompanies this redbook includes the following:

<i>File name</i>	<i>Description</i>
hpttoflr.c	HPTTOFLR Transform spooled file (uses QwpzHostPrintTransform)
hpttoflr.cmd	HPTTOFLR transform spooled file and write to folder
sg242160.pdf	First edition of the Printing V redbook
ws_ftp.log	FTP log file

K.2.1 How to use the Web material

Create a subdirectory (folder) on your workstation and copy the contents of the Web material into this folder.

Appendix L. Special notices

This publication is intended to help customers, business partners, and IBM system engineers who need to understand the fundamentals of printing on the AS/400 system to help them develop, or advise others about the design and development of AS/400 printing applications. The information in this publication is not intended as the specification of any programming interfaces that are provided by Print Services Facility/400, PrintSuite/400, AFP Utilities/400, and IBM Font Collection. See the PUBLICATIONS section of the IBM Programming Announcement for Print Services Facility/400, PrintSuite/400, AFP Utilities/400, and IBM Font Collection for more information about what publications are considered to be product documentation.

References in this publication to IBM products, programs or services do not imply that IBM intends to make these available in all countries in which IBM operates. Any reference to an IBM product, program, or service is not intended to state or imply that only IBM's product, program, or service may be used. Any functionally equivalent program that does not infringe any of IBM's intellectual property rights may be used instead of the IBM product, program or service.

Information in this book was developed in conjunction with use of the equipment specified, and is limited in application to those specific hardware and software products and levels.

IBM may have patents or pending patent applications covering subject matter in this document. The furnishing of this document does not give you any license to these patents. You can send license inquiries, in writing, to the IBM Director of Licensing, IBM Corporation, 500 Columbus Avenue, Thornwood, NY 10594 USA.

Licensees of this program who wish to have information about it for the purpose of enabling: (i) the exchange of information between independently created programs and other programs (including this one) and (ii) the mutual use of the information which has been exchanged, should contact IBM Corporation, Dept. 600A, Mail Drop 1329, Somers, NY 10589 USA.

Such information may be available, subject to appropriate terms and conditions, including in some cases, payment of a fee.

The information contained in this document has not been submitted to any formal IBM test and is distributed AS IS. The information about non-IBM ("vendor") products in this manual has been supplied by the vendor and IBM assumes no responsibility for its accuracy or completeness. The use of this information or the implementation of any of these techniques is a customer responsibility and depends on the customer's ability to evaluate and integrate them into the customer's operational environment. While each item may have been reviewed by IBM for accuracy in a specific situation, there is no guarantee that the same or similar results will be obtained elsewhere. Customers attempting to adapt these techniques to their own environments do so at their own risk.

Any performance data contained in this document was determined in a controlled environment, and therefore, the results that may be obtained in other operating environments may vary significantly. Users of this document should verify the applicable data for their specific environment.

The following document contains examples of data and reports used in daily business operations. To illustrate them as completely as possible, the examples contain the names of individuals, companies, brands, and products. All of these names are fictitious and any similarity to the names and addresses used by an actual business enterprise is entirely coincidental.

The following terms are trademarks of the International Business Machines Corporation in the United States and/or other countries:

IBM ®	Redbooks
	Redbooks Logo 
Advanced 36	Advanced Function Printing
AFCCU	AFP
AIX	APL2
APPN	AS/400
AS/400e	AT
BookMaster	ContentConnect
CT	Current
EDMSuite	GDDM
ImagePlus	InfoWindow
Intelligent Printer Data Stream	IPDS
Manage. Anything. Anywhere.	Netfinity
Network Station	OfficeVision
OfficeVision/400	Operating System/400
OS/2	OS/400
Print Services Facility	RMF
RS/6000	S/390
SecureWay	SOMobjects
SP	System/370
System/390	WIN-OS/2
Wizard	XT
400	Lotus
Freelance Graphics	Word Pro
Notes	Tivoli
TME	NetView
Cross-Site	Tivoli Ready
Tivoli Certified	Planet Tivoli

The following terms are trademarks of other companies:

Tivoli, Manage. Anything. Anywhere., The Power To Manage., Anything. Anywhere., TME, NetView, Cross-Site, Tivoli Ready, Tivoli Certified, Planet Tivoli, and Tivoli Enterprise are trademarks or registered trademarks of Tivoli Systems Inc., an IBM company, in the United States, other countries, or both. In Denmark, Tivoli is a trademark licensed from Kjøbenhavns Sommer - Tivoli A/S.

C-bus is a trademark of Corollary, Inc. in the United States and/or other countries.

Java and all Java-based trademarks and logos are trademarks or registered trademarks of Sun Microsystems, Inc. in the United States and/or other countries.

Microsoft, Windows, Windows NT, and the Windows logo are trademarks of Microsoft Corporation in the United States and/or other countries.

PC Direct is a trademark of Ziff Communications Company in the United States and/or other countries and is used by IBM Corporation under license.

ActionMedia, LANDesk, MMX, Pentium and ProShare are trademarks of Intel

Corporation in the United States and/or other countries.

UNIX is a registered trademark in the United States and other countries licensed exclusively through The Open Group.

SET, SET Secure Electronic Transaction, and the SET Logo are trademarks owned by SET Secure Electronic Transaction LLC.

Other company, product, and service names may be trademarks or service marks of others.

Appendix M. Related publications

The publications listed in this section are considered particularly suitable for a more detailed discussion of the topics covered in this redbook.

M.1 IBM Redbooks

For information on ordering these publications see “How to get IBM Redbooks” on page 415.

- *Inside AS/400 Client Access for Windows 95/NT, Version 3 Release 1 Modification 2*, SG24-4748
- *Managing AS/400 V4R4 with Operations Navigator*, SG24-5646

The following publications are available online in softcopy format only at the redbooks home page at: <http://www.redbooks.ibm.com>

At the site, click **Redbooks Online** and enter the book number in the search field that appears. Click **Submit Search**. When the search results appear, click the appropriate book title.

- *AS/400 Printing III*, GG24-4028
- *AS/400 Printing IV*, GG24-4389

M.2 IBM Redbooks collections

Redbooks are also available on the following CD-ROMs. Click the CD-ROMs button at ibm.com/redbooks for information about all the CD-ROMs offered, updates and formats.

CD-ROM Title	Collection Kit Number
IBM System/390 Redbooks Collection	SK2T-2177
IBM Networking Redbooks Collection	SK2T-6022
IBM Transaction Processing and Data Management Redbooks Collection	SK2T-8038
IBM Lotus Redbooks Collection	SK2T-8039
Tivoli Redbooks Collection	SK2T-8044
IBM AS/400 Redbooks Collection	SK2T-2849
IBM Netfinity Hardware and Software Redbooks Collection	SK2T-8046
IBM RS/6000 Redbooks Collection	SK2T-8043
IBM Application Development Redbooks Collection	SK2T-8037
IBM Enterprise Storage and Systems Management Solutions	SK3T-3694

M.3 Other resources

These publications are also relevant as further information sources:

- *IBM AFP Fonts: Font Samples*, G544-3792
- *IBM AFP Fonts: Font Summary*, G544-3810
- *IBM AFP Fonts: Licensed Program Specifications*, G544-5229
- *Ethernet and Token-Ring Configuration Guide*, G544-5240
- *Twinax/Coax Configuration Guide*, G544-5241
- *Infoprint Hi-Lite Color Introduction and Planning Guide*, G544-5420

- *IBM Intelligent Printer Data Stream Reference*, S544-3417
- *IBM AFP Fonts: Technical Reference for Code Pages*, S544-3802
- *IBM Page Printer Formatting Aid: User's Guide*, S544-5284
- *IPDS and SCS Technical Reference*, S544-5312
- *AS/400 Guide to AFP and Print Services Facility*, S544-5319
- *PCL5e and Postscript Technical Reference*, S544-5344
- *Advanced Function Printing Utilities for OS/400*, S544-5349
- *AS/400 Advanced Print Utility Users's Guide*, S544-5351
- *IBM AFP Toolbox for AS/400 User's Guide*, S544-5368
- *SAP R/3 AFP Print for AS/400 User's Guide*, S544-5412
- *Infoprint Manager for AIX Reference*, S544-5475
- *IBM Infoprint Manager for AIX PSF Direct: Network Configuration Guide for System/370*, S544-5486
- *Ethernet and Token Ring Configuration Guide (Infoprint 21)*, S544-5711
This publication is available in softcopy only at:
<http://publib.boulder.ibm.com/pubs/pdfs/prsys/54457112.pdf>
- *AFP Traditional Chinese Font Catalog*, SC18-0124
- *AFP Simplified Chinese Font Catalog*, SC18-0133
- *AFP Thai Font Catalog*, SC18-0137
- *AFP Japanese Font Catalog*, SC18-2332
- *Mixed Object Document Content Architecture Reference*, SC31-6802
- *Client Access/400 Personal Communications 5250 Reference Guide*, SC41-3553
- *AS/400 Workstation Customization Programming*, SC41-3605
- *AS/400 DDS Reference - Version 3*, SC41-3712
- *AS/400 Printer Device Programming - Version 3*, SC41-3713
- *AS/400 System API Reference - Version 3*, SC41-3801
- *Description Specifications Guide*, SC41-4712
- *OS/400 Printer Device Programming V4R2*, SC41-5713
- *AS/400 System API Reference - Version 4*, SC41-5801
- *Setting Up Printing in an Office Vision/400 Environment*, SH21-0511

The following publications are available in softcopy only from the AS/400 Online Library at: <http://as400bks.rochester.ibm.com/pubs/html/as400/online/lib.htm>

At the site, select your language and click **GO!**. Click **V3R2** and then **Search or view all V3R2 books**. In the search field that appears, enter the book number and click **Find**. Select the appropriate title that appears.

- *Internet Packet Exchange (IPX) Support*, SC41-3400
- *AS/400 TCP/IP Configuration and Reference - Version 3*, SC41-3420

M.4 Referenced Web sites

These Web sites are also relevant as further information sources:

- The latest version of the AFP Printer Driver may be obtained from:
<http://www.printers.ibm.com/afpdr.html>
- The AS/400 Programming Sampler is available online from the AS/400 printing Web site at: <http://www.printers.ibm.com/products.html>
- Information about the Uniform Code Council and UCC/EAN-128 can be found online at: <http://www.uc-council.org>
- Certain softcopy technical references can be downloaded free from the Web at: <http://www.printers.ibm.com/manuals.html>
- Token-Ring and Ethernet microcode can be accessed online at:
<http://www.printers.ibm.com/util.html>
- For information regarding Network Printer Manager, visit the Web site at:
<http://www.printers.ibm.com/npm.html>
- Selected DDS source code and a comprehensive library of AFP application examples can be found online in the AS/400 AFP Programming Sampler at:
<http://www.printers.ibm.com/as400>
- A “Printing from Java” overview for developers, written by Sun, can be found online at: <http://java.sun.com/products/jdk/1.1/docs/guide/awt/designspec/printing.html>
- Visit the IBM Redbooks home page at: <http://www.redbooks.ibm.com>
- The manual, *PSF Direct: AS/400 Configuration*, written for Infoprint Manager for Windows NT, can be found online at:
<http://www.printers.ibm.com/R5Psc.nsf/web/ntpsfd>
- There is a no-charge utility available to assist in loading your IBM AFP Font Collection (5648-B45) fonts in the special (QFNT01 to QFNT19) libraries. It can be found online at: <http://www.ibm.com/printers/as400>

How to get IBM Redbooks

This section explains how both customers and IBM employees can find out about IBM Redbooks, redpieces, and CD-ROMs. A form for ordering books and CD-ROMs by fax or e-mail is also provided.

- **Redbooks Web Site** ibm.com/redbooks

Search for, view, download, or order hardcopy/CD-ROM Redbooks from the Redbooks Web site. Also read redpieces and download additional materials (code samples or diskette/CD-ROM images) from this Redbooks site.

Redpieces are Redbooks in progress; not all Redbooks become redpieces and sometimes just a few chapters will be published this way. The intent is to get the information out much quicker than the formal publishing process allows.

- **E-mail Orders**

Send orders by e-mail including information from the IBM Redbooks fax order form to:

	e-mail address
In United States or Canada	pubscan@us.ibm.com
Outside North America	Contact information is in the "How to Order" section at this site: http://www.elink.ibm.ibm.com/pbl/pbl

- **Telephone Orders**

United States (toll free)	1-800-879-2755
Canada (toll free)	1-800-IBM-4YOU
Outside North America	Country coordinator phone number is in the "How to Order" section at this site: http://www.elink.ibm.ibm.com/pbl/pbl

- **Fax Orders**

United States (toll free)	1-800-445-9269
Canada	1-403-267-4455
Outside North America	Fax phone number is in the "How to Order" section at this site: http://www.elink.ibm.ibm.com/pbl/pbl

This information was current at the time of publication, but is continually subject to change. The latest information may be found at the Redbooks Web site.

IBM Intranet for Employees

IBM employees may register for information on workshops, residencies, and Redbooks by accessing the IBM Intranet Web site at <http://w3.itso.ibm.com/> and clicking the ITSO Mailing List button. Look in the Materials repository for workshops, presentations, papers, and Web pages developed and written by the ITSO technical professionals; click the Additional Materials button. Employees may access MyNews at <http://w3.ibm.com/> for redbook, residency, and workshop announcements.

Index

Symbols

- *AFPDS 5
- *AFPDSLNE 5
- *HPCP 104
- *HPFCS 104
- *IPDS 4
- *LINE 5
- *NOCOPY 63
- *NORMAL 63
- *NOWAIT 176
- *PHCP 104
- *PHFCS 103
- *REPRINT 63
- *SCS 4
- *USERASCII 5
- *USRDFNTXT 176

Numerics

- 2000-sheet finisher 214
- 240-pel fonts 94
- 300-pel euro symbol support 94
- 300-pel fonts 95
- 4230/4214 emulation mode 276
- 4247 native mode 277

A

- A3 page support 274
- action group entry 58
- activation timer 260
- Advanced Function Common Control Unit (AFCCU) 16
- Advanced Function Presentation
 - AFP resources 42
 - APU print model 37
 - AS/400 AFP model 35
 - creating AFP resources 43
 - overview of AFP on the AS/400 system 35
 - page and form definitions print model 41
 - PFU print model 39
 - toolbox print model 42
 - what is AFP 35
- Advanced Function Presentation (AFP) 35
- Advanced Function Presentation (AFP) Printer Driver 117
- Advanced Function Printing
 - AFP resource retention 282
 - AFPDS to ASCII transform 142
- Advanced Function Printing Data Stream (AFPDS) 5, 162
- Advanced Function Printing Utilities (AFPU) enhancements 398
- Advanced Print Utility
 - APU default setup 71
 - APU enhancements 49
 - APU environment 69
 - APU monitor enhancement 52
 - APU print model 37
 - configure APU Monitor Action 57
 - creating the print definition 72
 - fonts 69
 - print using the APU monitor 80
 - starting APU Monitor 65
 - using Advanced Print Utility 69
 - using APU monitor 56
 - working with the print definition 74
 - Advanced Print Utility (APU) 49, 67, 69
 - AFCCU (Advanced Function Common Control Unit) 16
 - AFCCU printers, stopping and starting 264
 - AFP (Advanced Function Presentation) 35
 - AFP compatibility fonts 93
 - AFP Font Collection 95
 - with PSF/400 396
 - AFP Font Collection with euro 400
 - AFP fonts created with Type Transformer 110
 - AFP model 35
 - AFP Printer Driver 117
 - creating an AFP document 134
 - creating an overlay 122
 - creating efficient AFP resources 284
 - creating page segment 126
 - file transfer of AFP resources using FTP 130
 - images dialog box 130
 - installing AFP printer driver 118
 - other AFP printer driver tasks 130
 - overview 117
 - performance of AFP printer driver 134
 - text or image 129
 - why use the AFP printer driver 117
 - AFP PrintSuite for AS/400 401
 - AFP resource creation 43
 - AFP resources 42, 43, 84
 - AFP toolbox print model 42
 - AFP Utilities 45, 403
 - AFP Workbench in Client Access/400 399
 - AFP/IPDS support for OneWorld 396
 - AFPDS (Advanced Function Printing Data Stream) 5
 - AFPDS line data stream 5
 - AFPDS spooled file 23, 25
 - AFPU V4R2 enhancements 45
 - application programming interface
 - ESPDRVXT (print driver exit) 307
 - ESPTRNXT (writer transform exit) 307
 - QGSCPYRS (copy AFPDS resources) 307
 - QGSLRSC (list spooled file AFPDS resources) 307
 - QIMGCVTI (convert image) 168
 - QSPBOPNC (build open time commands) 307
 - QSPBSEPP (build separator page) 307
 - QSPEXTWI (extract writer status) 306
 - QSPSETWI (set writer status) 306
 - QSPSNQWM (send writer message) 307
 - QWPZHPTR (host print transform) 307
 - APU (Advanced Print Utility) 49, 67
 - APU default setup 71
 - APU environment 69
 - APU monitor 56, 65
 - first version 80
 - new version 80

- APU monitor action 57
- APU monitor enhancement 52
- APU print engine 66
- APU print model 37
- APU versus PPFA 88
- AS/400 AFP model 35
- AS/400 font management 398
- AS/400 network printers 205
- AS/400 output on a PC printer 194
- AS/400 print profile 191
- ASCII data stream 5
- ASCII printers 165, 277
 - attached to displays 17
 - attached to PCs 18
 - LAN-attached 19
- ASCII printing 277
- attachment methods
 - ASCII printers attached to displays 17
 - ASCII printers attached to PCs 18
 - ASCII printers LAN-attached 19
 - IPDS printers LAN-attached 16
 - printers attached to PSF Direct 20
 - printers attached to PSF/2 DPF 21
 - printers attached to WSC or 5x94 15
- automatic resolution 399
- auxiliary tray 213

B

- BCOCA application 332
- BCOCA object 332
- bin and tray selection 212
- BOOTP (Bootstrap Protocol) 237
- Bootstrap Protocol (BOOTP) 237

C

- calculated processor utilization 329
- CDEFNT (Coded Font) 92
- Change Spooled File Attributes (CHSPLFA) 2
- characters per inch (CPI) 92
- CHSPLFA (Change Spooled File Attributes) 2
- Client Access/400 printing
 - AS/400 print profile 191
 - AS/400 printer to Windows 95 186
 - considerations on CA/400 network printing 193
 - network printer setup 191
 - Network Printing function 186
 - overview 185
 - Printer Definition Table (PDT) 200
 - printer emulation 194
 - printing AS/400 output on PC printer 194
- Coded Font (CDEFNT) 92
- commands
 - ADDNTWAUTE (Add NetWare Authentication) 182
 - CHGSPLFA (Change Spooled File Attributes) 2
 - CRTOUTQ (Create Output Queue) 172
 - CRTPSFCFG (Create PSF Configuration (V3R2)) 227
 - CRTWSCST (Create WSCST) 152
 - ENDWTR (End Writer) 3
 - RTVWSCST (Retrieve WSCST) 152

- STRNTWCNN (Start NetWare Connection) 182
- STRPRTWTR (Start Print Writer) 3
- STRRMTWTR (Start Remote Writer) 176
- WRKCFGSTS (Work with Configuration Status) 3
- WRKOUTQ (Work with Output Queue) 2
- WRKSPLF (Work with Spooled Files) 2
- WRKSPLFA (Work with Spooled File Attributes) 2
- communication problems 253
- comparison of printing rate 326
- comparison of processor requirements 328
- Computer Output Reduction (COR) 273
- CONFIG MENU 210
- configuration problems 253
- configuring for remote system printing 258
- connection problems 253
- constant back overlay in the printer file 397
- Content Manager OnDemand for AS/400 398
- convert image API 168
- convert image API (QIMGCVTI) 163
- converting PostScript data streams 168
- copying spooled files 269
- COR 101
- COR (Computer Output Reduction) 273
- COR top margin 218
- CPI (characters per inch) parameter 92
- create source for form and page definitions 82
- creating an overlay 122
- creating page segment 126
- customer-defined font ranges 106
- cut-sheet emulation 402

D

- data description specification (DDS) 287
- data streams
 - AFPDS (Advanced Function Printing Data Stream) 5
 - AFPDSLIN (AFPDS line data stream) 5
 - AS/400 generated IPDS (full IPDS) 8
 - data streams on the AS/400 system 3
 - IPDS (Intelligent Printer Data Stream) 4
 - LINE (Line data stream) 5
 - SCS (SNA Character String) 4
 - USERASCII (ASCII data stream) 5
- DBCS support in host print transform 156
 - DBCS AFPDS to ASCII transform 157
 - DBCS EBCDIC to ASCII transform 156
 - DBCS SCS to ASCII transform 156
 - new tags 157
 - new WSCST objects 157
 - supported data streams 157
- DDS (data description specification) 287
- DDS functionality example 287
- DDS functionality specification 290
- destination options 176
- DESTOPT parameter 176
- device description 224, 230
- DEVTYPE 28
- disabling resident font support 106
- drawer and paper path selection problems 276
- dual-configuration printer 207
- dual-shared configuration printer 207

duplex 49
duplicate IP address 260

E

edge-to-edge printing 221
element repeat 47
End Writer (ENDWTR) 3
ending the writer 261
ENDWTR (End Writer) 3
enhancing your output 67
euro with AFP Font Collection 400
externally-described printer file 36

F

FGID (Font Global Identifier) 91
fidelity parameter 269
File field 64
finishing support 403
FNTCHRSET (Font Character Set) 92
FONT (Font Global Identifier) 91
font capture 402
font capturing 108
Font Character Set (FNTCHRSET) 92
Font Character Set to Font ID 102
Font Global Identifier (FGID) 91
Font ID to Font Character Set 102
Font ID to Font ID 102
font mapping 101
font performance 400
font resource 108, 109
font substitution 169
font substitution messages 102, 275, 403
font table command 105
font table customization 103
font table entry 104
font tables 103
fonts 43, 69, 93
 240-pel fonts available at a charge 94
 300-pel fonts available at a charge 95
 AFP Font Collection 95
 at no charge 93
 customer-defined font ranges 106
 disabling resident font support 106
 font substitution 101
 font tables customization 103
 host-resident fonts 90
 installation 96
 making the fonts available 97
 outline fonts 99
 PostScript 168
 printer-resident fonts 89
 problems 274
 selection 91
 storage 89
 suppressing font substitution messages 102
 user-supplied 169
 using resource library list 107
force new sheet DDS 397
form and page definition object 85

form and page definitions 84, 86
form definition 43, 47
Form Type field 64
formatting 287

G

Graphics Interchange Format (GIF) 161

H

hardware 318
Hewlett-Packard Printer Control Language (PCL) 162
Hold field 64
host print transform 13, 332
 AFPDS to ASCII transform 142
 AFPDS to TIFF 150
 create WSCST object 152
 customization 151
 DBCS support 156
 enabling host print transform 140
 enhancements 138
 mapping mode 143
 new and enhanced tags for WSCST objects 152
 new MFRTYPMDL special values 154
 no print border (AFPDS to ASCII) 149
 NOPRTBDR tag example 142
 overview 137
 process 139
 processing AFP resources 148
 processing barcodes 148
 raster mode 146
 retrieve WSCST object 152
 SCS to ASCII transform 140
 transform limitations 150
 transform spooled file, write to folder 150
 unprintable border 141
Host to Printer-resident Code Page 104
Host to Printer-resident Font Character Set 104
host-resident fonts 90
host-resident outline font 48, 100
HPT ASCII printers versus PSF/400 IPDS 32

I

IBM 4247 paper path selection 276
IBM 5x94 15
I-DATA-7913 LAN attachment 237
indexing keyword in DDS 399
image compression 329
image configuration objects 166
image print transform 14, 161
 Advanced Function Printing Data Stream (AFPDS) 162
 convert image (QIMGCVTI) API 168
 converting PostScript data streams 168
 definition 161
 Graphics Interchange Format (GIF) 161
 Hewlett-Packard Printer Control Language (PCL) 162
 image configuration objects 166
 OS/2 and Windows Bitmap (BMP) 161

- PostScript Level 1 161, 162
 - printing 165
 - printing to an ASCII printer 165
 - printing to an IPDS printer 166
 - printing with image print transform 165
 - process 163
 - sending the spooled files 166
 - Tag Image File Format (TIFF) 161
 - troubleshooting 170
 - using 162
- Image Print Transform Services for OS/400 401
- implementing a printing concept 27
- Infoprint 21 SNMP driver 395
- Infoprint 4000 318
- Infoprint 60 318
- InfoWindow displays 17
- input spooled file action 60
- input spooled file selection criteria 59
- input trays 213
- insert DDS 397
- installing AFP printer driver 118
- Intelligent Printer Data Stream (IPDS) 4
- INVNEW1 program 292
- IP4000 318
- IP4000 printer 325
- IP60 printer 323
- IPDS (Intelligent Printer Data Stream) 4
- IPDS MENU 211
- IPDS menu PAGE setting 218
- IPDS pass through 282, 400
- IPDS printer 166
- IPDS printers LAN-attached 16
- IPDS spooled file 23, 24
- IPDS, AFP=*NO 216
- IPDS, AFP=*YES 216

J

- J option 176
- J.D. Edwards OneWorld Xe 396

L

- LAN-attached ASCII printers 19, 238
 - using LexLink 238
 - using PJI drivers 241
 - using SNMP drivers 246
- LAN-attached IPDS printers 16, 223, 257
 - on V3R2 224
 - on V3R7 and later 230
- LAN-attached printers 223
- library list searches 284
- line data 399
- line data stream 5
- line printer daemon (LPD) 172
- line printer requester (LPR) 172
- load letter message 179
- logical and physical page origin 217
- logical page 271

M

- mailbox bins 214
- mapping mode, processing AFP fonts 143
- message queue full 260
- messages
 - PQT3603 255
 - PQT3630 268
- microcode 212
- mixed data stream 5
- monitor actions example 54
- monitor example 53
- Multiple Text Mapping 50
- MULTIUP 101

N

- NetWare
 - *BANNER option 184
 - *NOWAIT option 184
 - Add NetWare Authentication 182
 - AS/400 and NetWare Printing 181
 - Create Output Queue 182
 - preparing for remote system printing 182
 - Start NetWare Connection 182
- NetWare printing 181
- Network Printer 12/17 221
- Network Printer 24 221, 318
- Network Printer Manager 215
- network printers 205
 - attachment information 215
 - configuration scenarios 206
 - dual-configuration printer 207
 - edge-to-edge printing 221
 - IPDS menu PAGE setting 218
 - LAN-attached IPDS printer 206
 - microcode 212
 - Network Printer Manager 215
 - output presentation 216
 - overview 205
 - printer menu details 209
 - printer setup 209
 - setup 191
 - shared dual-configuration printer 207
 - shared multi-purpose printer 208
 - tray and bin selection 212
 - using the QPRTVALS Data Area 217
- Network Printing considerations 193
- Network Printing function for CA/400 186
- network station
 - local printing 311
 - print driver 309
 - printing 309
 - printing from Java 311
- NP24 printer 322

O

- OEM products 45
- Offset Stacker/Jogger 214
- Omit Back Side Page Layout 47
- OneWorld AFP/IPDS support 396

- OS/2 and Windows bitmap (BMP) 161
- OS/400 Image Print Transform Services 401
- OS/400 printing enhancements 395
- outline font 99, 100
- outline font support 52, 402
- output attributes 165
- output bin DDS 397
- Output bin field 65
- output bins 214
- Output device parameter 64
- output enhancement 67
 - Advanced Print Utility 67
 - Page Printer Formatting Aid 67
 - using Advanced Print Utility (APU) 69
 - using PPFA 81
- output from an AS/400 on a PC printer 194
- output presentation 33, 216
- output queue 172
 - NetWare 182
 - spooled files 1
- Output queue parameter 64
- output queue status 263
- output spooled file action 60, 62
- overlay 43
- overlay rotation DDS 397
- Overlay Utility 45

P

- page and form definitions print model 41
- page definition 43
- Page Printer Formatting Aid
 - compile the form and page definitions 84
 - create source for form and page definition 82
 - create the form and page definition objects 85
 - page and form definitions print model 41
 - printing with form and page definitions 86
 - using PPFA 81
- Page Printer Formatting Aid (PPFA) 67, 81
- page segment 43
- PAGE setting 218
- PAGE=COMP1 220
- PAGE=COMP2 220
- PAGE=PRINT 219
- PAGE=WHOLE 218
- PAPER MENU 209
- PCs connected to ASCII printers 18
- PDT (printer definition table) 200
- performance
 - AFP resource retention 282
 - AS/400 system storage 279
 - clear memory for security 283
 - creating efficient AFP resources 284
 - data stream type 280
 - font types 283
 - IPDS pass through 282
 - library list searches 284
 - printer device description parameters 282
 - printer file parameters 285
 - printer settings 285
 - PSF configuration object parameters 285

- performance monitor 319
- PFU (Print Format Utility) 39
- PFU print model 39
- physical page 271
- ping TCP/IP address 254
- PJL (Print Job Language) 255
- port number 254
- positioning data
 - logical page 271
 - physical page 271
 - problem with output presentation 271
- PostScript data streams 168
- PostScript fonts 168
- PostScript Level 1 161, 162
- PostScript transform 400
- PPFA (Page Printer Formatting Aid) 67, 81
- PPFA versus APU 88
- PQT3603 message 255
- PQT3630 message 268
- print and convert mode 322
- print criticality 27
- print definition 65, 72, 74
 - testing 79
- Print definition parameter 63
- print engine 66
- print finishing 398
- Print Format Utility 47
- Print Format Utility (PFU) 39
- Print Job Language (PJL) support 255
- print openness
 - additional functions 306
 - additional functions on the output queue commands 305
 - additional functions on the printer file 304
 - additional functions on the PRTDEV commands 304
 - new APIs 306
- print output 68
- print output requirements 27
- print profile 191
- Print Services Facility/400 9
 - PSF/400 already installed 11
 - PSF/400 IPDS printers versus HPT ASCII printers 32
 - PSF/400 process 10
- Print to Host-resident Font Character Set 103
- print writer 8
- printer attached methods 32
- printer attachment methods 15
- printer definition table (PDT) 200
- printer DEVTYPE 28
- printer emulation session 194
- printer ends 259
- printer file DDS 287
- printer file device type 27
- printer menu details 209
- printer ranges for PSF/400 396
- printer requirements 30
- printer setup 209, 273
- Printer to Host-resident Code Page 104
- printer type 48
- printer writer 6

- printer-resident fonts 89
- printers attached to PSF Direct 20
- printers attached to PSF/2 DPF 21
- printers attached to WSC or 5x94 15
- printer-writer-related problems 259
- printing AS/400 output on PC printer 194
- printing concept 27
 - considerations 32
 - enhancing your output presentation 33
 - print criticality 27
 - print output requirements 27
 - printer attachment methods 32
 - printer file device type 27
 - printer requirements 30
 - PSF/400 IPDS printers versus HPT ASCII printers 32
 - type of printers 30
 - writer supporting printer DEVTYPE 28
- printing enhancements for OS/400 395
- printing from Java 311
- printing on ASCII printers 277
- printing on the AS/400
 - data streams on the AS/400 system 3
 - host print transform 13
 - image print transform 14
 - implementing a printing concept 27
 - output queues 1
 - Print Services Facility/400 9
 - printer attachment methods 15
 - printer writer 6
 - Printing SCS, IPDS, AFPDS, and USERASCII spooled files 23
 - remote system printing 22
 - spooled files 1
- printing on the AS/400 system 1
- printing SCS, IPDS, AFPDS, and USERASCII spooled files 23
- printing with image print transform 165
- print-resident font 319
- problem determination
 - A3 page support 274
 - additional information 278
 - AFCCU printers, stopping and starting 264
 - communication, connection, configuration problems 253
 - computer output reduction 273
 - configuring LAN-attached IPDS printers 257
 - drawer and paper path selection problems 276
 - fidelity parameter 269
 - font problem 274
 - message PQT3603 255
 - message PQT3630 268
 - output queue status 263
 - ping TCP/IP address 254
 - port number 254
 - Print Job Language (PJM) support 255
 - printer setup 273
 - printing on ASCII printers 277
 - problem with output presentation 271
 - problem with shading 276
 - QSTRUP execution during IPL 264
 - remote printer queue name 258
 - setting up TCP/IP network on AS/400 253
 - spooled file goes to hold status 266
 - spooled file status 262
 - spooled files remain in PND status 261
 - spooled files remain in RDY status 260
 - SSAP values in line description 253
 - where your print output goes 265
 - writer cannot re-direct spooled file 267
- problem determination techniques 253
- problem with output presentation 271
- program, INVNEW1 292
- program-described printer file 36
- PSF configuration object 227, 234
 - V3R7 and later 234
- PSF Direct connected to printers 20
- PSF trace 319
- PSF/2 DPF connected to printers 21
- PSF/400 IPDS printers versus HPT ASCII printers 32
- PSF/400 printer ranges 396
- PSF/400 spooled file conversion 331
- PSF/400 V4R2 performance 317
- PSF/400 V4R2 performance parameter 318
- PSF/400 V4R2 software 317
- PSF/400 with AFP Font Collection 396
- PTFs 278

Q

- QFNT240LA1 96
- QFNT300CPL 96
- QFNT300LA1 96
- QFNTCDEPAG 96
- QFNTCFOLA1 96
- QFNTCPL 96
- QIMGCVTI 163, 168
- QPRTVALS data area 217
- QSTRUP execution during IPL 264
- QSTRUP program
 - at IPL 264
 - changing 264
- queues to be monitored 57

R

- raster mode processing AFP fonts 146
- recommended PTF levels 212
- record format 301
- release timer 260
- remote printer queue 173
- remote printer queue name 258
- remote system printing 22, 182, 258
 - create output queue 172
 - destination options 176
 - line printer daemon (LPD) 172
 - line printer requester (LPR) 172
 - load letter message 179
 - NetWare printing 181
 - overview 171
 - remote printer queue 173
 - remote printer queue name 258

- separator pages 178
- Start Remote Writer 176
- TCP/IP LPR-LPD printing 172
- XAI option 176
- XAUTOQ option 177
- resident font support 106
- resource library list 107
- rotating and sizing page segments 400

S

- Save field 65
- scalable fonts for MULTIUP and COR 101
- SCS (SNA Character String) 4
- SCS mode 216
- SCS spooled file 23
- separator pages 178
- shading at different resolutions 276
- shared multi-purpose printer 208
- simplex/duplex mode switching DDS 397
- sizing and rotating page segments 400
- SNA Character String (SCS) 4
- SNMP ASCII printer driver 395
- SNMP driver for Infoprint 21 395
- software, PSF/400 V4R2 317
- source physical file 82
- Source Service Access Point (SSAP) 253
- spooled files
 - copying 269
 - copying spooled files 269
 - hold status 266
 - image print transform 166
 - output queue 1
 - printing AFPDS spooled files 25
 - printing IPDS spooled files 24
 - printing SCS spooled files 23
 - printing USERASCII spooled files 25
 - printing USERASCII spooled files with the image print transform 26
 - remain in PND status 261
 - remain in RDY status 260
 - status 262
 - writer cannot re-direct 267
- SSAP (Source Service Access Point) 253
- SSAP values in line description 253
- Start Printer Writer (STRPRTWTR) 3
- STRPRTWTR (Start Printer Writer) 3
- substitution messages for fonts 275
- suppressing font substitution messages 102
- switching DDS 397

T

- Tag Image File Format (TIFF) 161
- TCP/IP
 - ping TCP/IP address 254
 - setting up TCP/IP network on AS/400 253
 - TCP/IP BOOT Service (V4R1 and later) 237
 - TCP/IP LPR-LPD printing 172
- TCP/IP BOOT Service (V4R1 and later) 237
- TCP/IP configuration 403

- TCP/IP network on AS/400 253
- TEST MENU 209
- TOKEN RING and ETHERNET MENU 210
- transform spooled file, write to folder 150
- tray and bin selection 212
- troubleshooting print image transform 170
- tutorial 48
- TWINAX SCS MENU 210
- TWINAX SETUP MENU 210
- Type Transformer 110
- Type Transformer for Windows 396
- types of printers 30

U

- User data field 64
- User exit after field 65
- User exit before parameter 63
- User exit middle field 64
- USERASCII spooled file 23, 25
 - printing with image print transform 26
- user-supplied fonts 169

V

- view electronic form on PC 45

W

- where print output goes 265
- Work Station Customizing Objects (WSCST) 14
- Work with Configuration Status (WRKCFGSTS) 3
- Work with Output Queue (WRKOUTQ) 2
- Work with Spooled File Attributes (WRKSPLFA) 2
- Work with Spooled Files (WRKSPLF) 2
- workstation controller 15
- Workstation Customizing Object
 - *WSCSTA3 155
 - *WSCSTA4 155
 - *WSCSTA5 155
 - *WSCSTB4 155
 - *WSCSTB5 155
 - *WSCSTCONT132 155
 - *WSCSTCONT80 155
 - *WSCSTEXECUTIVE 155
 - *WSCSTLEGAL 155
 - *WSCSTLETTER 155
 - *WSCSTNONE 155
- WRKCFGSTS (Work with Configuration Status) 3
- WRKOUTQ (Work with Output Queue) 2
- WRKSPLF (Work with Spooled Files) 2
- WRKSPLFA (Work with Spooled File Attributes) 2
- WSCST (Work Station Customizing Objects) 14

X

- XAI option 176
- XAUTOQ option 177

Z

- z-fold DDS 397

IBM Redbooks review

Your feedback is valued by the Redbook authors. In particular we are interested in situations where a Redbook "made the difference" in a task or problem you encountered. Using one of the following methods, **please review the Redbook, addressing value, subject matter, structure, depth and quality as appropriate.**

- Use the online **Contact us** review redbook form found at ibm.com/redbooks
- Fax this form to: USA International Access Code + 1 914 432 8264
- Send your comments in an Internet note to redbook@us.ibm.com

Document Number	SG24-2160-01
Redbook Title	IBM AS/400 Printing V
Review	
What other subjects would you like to see IBM Redbooks address?	
Please rate your overall satisfaction:	<input type="radio"/> Very Good <input type="radio"/> Good <input type="radio"/> Average <input type="radio"/> Poor
Please identify yourself as belonging to one of the following groups:	<input type="radio"/> Customer <input type="radio"/> Business Partner <input type="radio"/> Solution Developer <input type="radio"/> IBM, Lotus or Tivoli Employee <input type="radio"/> None of the above
Your email address: The data you provide here may be used to provide you with information from IBM or our business partners about our products, services or activities.	<input type="checkbox"/> Please do not use the information collected here for future marketing or promotional contacts or other communications beyond the scope of this transaction.
Questions about IBM's privacy policy?	The following link explains how we protect your personal information. ibm.com/privacy/yourprivacy/



Redbooks

IBM AS/400 Printing V

(0.5" spine)

0.475" x 0.873"

250 x 459 pages



IBM AS/400 Printing V

**A primer on AS/400
printing in today's
networked environment**

**Configuration,
performance, problem
determination,
enhancements**

**In-depth education on
AFP and ASCII printing**

This IBM Redbook describes how to use printing functions on the AS/400 system. It supplements the standard reference documents on AS/400 printing by providing more specific “how to” information, such as diagrams, programming samples, and working examples. It addresses the printing function found in OS/400, Print Services Facility/400 (PSF/400), Advanced Print Utility, Page Printer Formatting Aid, AFP Font Collection, and other print-enabling software. The original edition applied to Version 3 Release 2 for CISC systems and Version 4 Release 2 for RISC systems. This second edition includes information about the new functions that are available in releases up to and including Version 4 Release 5.

This document is intended for customers, business partners, and IBM systems specialists who need to understand the fundamentals of printing on the AS/400 system. It is designed to help you develop or advise others concerning the design and development of AS/400 printing applications.

This document is not intended to replace existing AS/400 printing publications, but rather to expand on them by providing detailed information and examples.

**INTERNATIONAL
TECHNICAL
SUPPORT
ORGANIZATION**

**BUILDING TECHNICAL
INFORMATION BASED ON
PRACTICAL EXPERIENCE**

IBM Redbooks are developed by the IBM International Technical Support Organization. Experts from IBM, Customers and Partners from around the world create timely technical information based on realistic scenarios. Specific recommendations are provided to help you implement IT solutions more effectively in your environment.

**For more information:
ibm.com/redbooks**

SG24-2160-01

ISBN 0738419443